



FailSafe™ Administrator's Guide for  
SGI® InfiniteStorage

007-3901-012

---

## CONTRIBUTORS

Written by Jenn Byrnes, Susan Ellis, Lori Johnson, Steven Levine

Illustrated by Chrystie Danzer, Dany Galgani

Production by Karen Jacobson

Engineering contributions by Gemma Exton, Scott Henry, Vidula Iyer, Ashwinee Khaladkar, Harald Kaul, Tony Kavadias, Linda Lait, Michael Nishimoto, Nate Pearlstein, Alain Renaud, Wesley Smith, Bill Sparks, Paddy Sreenivasan, Dan Stekloff, Rebecca Underwood, Manish Verma

---

## COPYRIGHT

© 1999–2004, Silicon Graphics, Inc. All rights reserved; provided portions may be copyright in third parties, as indicated elsewhere herein. No permission is granted to copy, distribute, or create derivative works from the contents of this electronic documentation in any manner, in whole or in part, without the prior written permission of Silicon Graphics, Inc.

---

## LIMITED RIGHTS LEGEND

The software described in this document is "commercial computer software" provided with restricted rights (except as to included open/free source) as specified in the FAR 52.227-19 and/or the DFAR 227.7202, or successive sections. Use beyond license provisions is a violation of worldwide intellectual property laws, treaties and conventions. This document is provided with limited rights as defined in 52.227-14.

---

## TRADEMARKS AND ATTRIBUTIONS

Silicon Graphics, SGI, the SGI logo, IRIS, IRIX, Onyx, Onyx2, Origin, and XFS are registered trademarks and CXFS, FailSafe, IRIS FailSafe, NUMAlink, Performance Co-Pilot, SGI SAN Server, and Silicon Graphics Fuel are trademarks of Silicon Graphics, Inc., in the United States and/or other countries worldwide.

Informix is a registered trademark of IBM. Java is a trademark of Sun Microsystems, Inc. Netscape and Netscape FastTrack Server are trademarks of Netscape Communications Corporation. Oracle is a registered trademark of Oracle Corporation. UNIX is a registered trademark of The Open Group in the United States and other countries. All other trademarks mentioned herein are the property of their respective owners.

---

## New Features in This Guide

This revision contains the following new information:

- "Local Failover of HA IP Addresses" on page 56 and "Example: Local Failover of HA IP Address" on page 279
- "Differences When Performing a Remote or Miniroot Install" on page 91



---

## Record of Revision

<b>Version</b>	<b>Description</b>
002	December 1999 Published in conjunction with FailSafe 2.0 rollup patch. Supports IRIX 6.5.2 and later.
003	November 2000 Supports IRIS FailSafe 2.1
004	May 2001 Supports IRIS FailSafe 2.1.1
005	October 2001 Supports IRIS FailSafe 2.1.2
006	April 2002 Supports IRIS FailSafe 2.1.3
007	October 2002 Supports IRIS FailSafe 2.1.4
008	April 2003 Supports IRIS FailSafe 2.1.5
009	November 2003 Supports IRIS FailSafe 2.1.6
010	January 2004 Supports IRIS FailSafe 2.1.6 and IRIX 6.5.23
011	November 2004 Supports IRIS FailSafe 2.1.6 and IRIX 6.5.26
012	January 2005 Supports IRIS FailSafe 2.1.6 and IRIX 6.5.27



---

# Contents

<b>About This Guide</b>	xxxix
Audience	xxxix
Assumptions	xxxix
Structure of This Guide	xxxix
Related Documentation	xxxix
Obtaining Publications	xxxix
Conventions	xxxix
Reader Comments	xxxix
<b>1. Overview</b>	<b>1</b>
High Availability with FailSafe	1
Complete Storage Solution: FailSafe, CXFS, DMF, and TMF	2
CXFS	2
DMF	4
TMF	4
Cluster Environment	4
Terminology	5
Cluster	5
Node	5
Pool	5
Cluster Database	6
Membership	7
Quorum	7
Private Network	9
Resource	10

Resource Type . . . . .	10
Resource Name . . . . .	11
Resource Group . . . . .	11
Dependency . . . . .	12
Failover . . . . .	13
Failover Policy . . . . .	14
Failover Domain . . . . .	14
Failover Attribute . . . . .	14
Failover Scripts . . . . .	15
Action Scripts . . . . .	15
Cluster Process Group . . . . .	16
Plug-In . . . . .	16
Hardware Components . . . . .	17
Disk Connections . . . . .	19
Supported Configurations . . . . .	19
Additional Features . . . . .	22
Dynamic Management . . . . .	22
Fine-Grain Failover . . . . .	22
Local Restarts . . . . .	23
Administration . . . . .	23
Highly Available Resources . . . . .	24
Nodes . . . . .	24
Network Interfaces and IP Addresses . . . . .	24
Disks . . . . .	26
Highly Available Applications . . . . .	28
Failover and Recovery Processes . . . . .	28
Overview of Configuring and Testing a New Cluster . . . . .	29
Release Support Policy . . . . .	30



<b>2. Configuration Planning</b>	<b>31</b>
Example of the Planning Process	31
Disk Configuration	32
Planning Disk Configuration	33
Configuration Parameters for Disks	38
XFS Filesystem Configuration	38
XLV Logical Volumes	38
Example Logical Volume Configuration	39
Resource Attributes for Logical Volumes	39
Local XVM Volumes	40
xvm Resource Type for FailSafe	40
Resource Attributes for Local XVM Volumes	40
Example Local XVM Volume Configuration	41
Local XVM Snapshots	41
Planning XFS Filesystems	42
Example XLV Filesystem Configuration	45
CXFS Filesystem Configuration	46
Planning CXFS Filesystems	46
Coexecution of CXFS and FailSafe	47
Size of the Coexecution Cluster	49
Cluster Type	49
Node Types for CXFS Metadata Servers	50
CXFS Metadata Servers and Failover Domain	50
CXFS Resource Type for FailSafe	50
Separate CXFS and FailSafe GUIs	52
Conversion Between CXFS and FailSafe	52
Network Interfaces	53

HA IP Address Configuration . . . . .	53
Planning Network Interface and HA IP Address Configuration . . . . .	54
Determining if Re-MACing is Required . . . . .	55
Example HA IP Address Configuration . . . . .	56
Local Failover of HA IP Addresses . . . . .	56
Using FailSafe with SGI Gigabit Ethernet Interfaces . . . . .	57
<b>3. Best Practices . . . . .</b>	<b>59</b>
Planning and Installing a FailSafe Cluster . . . . .	59
How Do You Want to Use FailSafe? . . . . .	59
Hardware Requirements . . . . .	61
Software Installation . . . . .	63
FailSafe Plugins . . . . .	63
Upgrades . . . . .	64
Customer Education . . . . .	65
Knowing the Tools . . . . .	65
Physical Storage Tools . . . . .	65
Cluster Configuration Tools . . . . .	66
Cluster Control Tools . . . . .	66
Networking Tools . . . . .	66
Cluster/Node Status Tools . . . . .	66
Performance Monitoring Tools . . . . .	67
Log Files . . . . .	67
FailSafe Diagnostic Commands . . . . .	68
Configuration . . . . .	68
System File Configuration . . . . .	69
Cluster Database Configuration . . . . .	71
Using the Administration Tools . . . . .	72

---

Determining the Number of Pools . . . . .	73
Node Names . . . . .	73
Issues with a Two-Node Cluster . . . . .	74
Determining Which Nodes Perform Resets . . . . .	74
Network Interface and Hostnames vs IP Addresses . . . . .	74
Appropriate Timeout Determination . . . . .	74
Tiebreaker Nodes . . . . .	74
Log Files . . . . .	75
Offline Detach Issues . . . . .	75
Testing the Configuration . . . . .	76
Administration and Operation . . . . .	77
Appropriate Dependencies for <code>filesystem</code> Resources . . . . .	77
Enabling System Accounting . . . . .	78
Origin 300, Origin 3200C, Onyx 300, and Onyx 3200C Console Support . . . . .	78
Creating an Emergency Failover Policy for a Two-Node Cluster . . . . .	79
Interrupting FailSafe Commands . . . . .	79
Monitoring System Status . . . . .	80
System Maintenance . . . . .	80
Understanding What Happens After a System Crash or Hang . . . . .	81
Cluster Database Backup and Restore . . . . .	81
Log File Management . . . . .	82
Networking . . . . .	82
Fix Networking Problems First . . . . .	82
Improve Availability by using UDP . . . . .	82
NFS . . . . .	82
Security . . . . .	83
Tuning . . . . .	83

Large Filesystems . . . . .	83
CXFS and DMF, NFS, and Samba Resource Types . . . . .	83
Avoiding Problems . . . . .	84
Proper Start Up . . . . .	84
Cluster Database Membership Quorum Stability . . . . .	84
Consistency in Configuration . . . . .	85
GUI Use . . . . .	85
Log File Names and Sizes . . . . .	85
Removing Unused Nodes . . . . .	85
<b>4. FailSafe Installation and System Preparation . . . . .</b>	<b>87</b>
Install FailSafe . . . . .	87
Install Procedure . . . . .	87
Differences When Performing a Remote or Miniroot Install . . . . .	91
Configure System Files . . . . .	92
/etc/services . . . . .	93
/etc/config/cad.options . . . . .	93
/etc/config/fs2d.options . . . . .	94
Example 1 . . . . .	96
Example 2 . . . . .	97
/etc/config/cmond.options . . . . .	97
Set the corepluspid System Parameter . . . . .	98
Set NVRAM Variables . . . . .	98
Create XLV Logical Volumes and XFS Filesystems . . . . .	98
Configure Network Interfaces . . . . .	100
Configure the Ring Reset Serial Port . . . . .	104
Install Patches . . . . .	105
Installing FailSafe 2.x and a FailSafe Patch at the Same Time . . . . .	105

Installing a FailSafe Patch on an Existing FailSafe 2.x Cluster . . . . .	106
Install Performance Co-Pilot Software . . . . .	109
Installing the Collector Host . . . . .	110
Removing Performance Metrics from a Collector Host . . . . .	111
Installing the Monitor Host . . . . .	112
Test the System . . . . .	113
Private Network Interface . . . . .	113
Serial Reset Connection . . . . .	114
Modifications Required for Connectivity Diagnostics . . . . .	116
<b>5. Administration Tools . . . . .</b>	<b>117</b>
FailSafe Manager GUI . . . . .	117
Starting the GUI and Connecting to a Node . . . . .	117
Starting the GUI . . . . .	117
Starting the GUI on a PC . . . . .	118
Summary of GUI Platforms . . . . .	119
Logging In . . . . .	119
Making Changes Safely . . . . .	120
GUI Features . . . . .	120
GUI Window Layout . . . . .	121
File Menu . . . . .	121
Edit Menu . . . . .	122
Tasks Menu . . . . .	122
Help Menu . . . . .	122
View Menu . . . . .	123
Selecting Items to View or Modify . . . . .	123
Viewing Component Details . . . . .	123
Performing Tasks . . . . .	124

Getting More Information . . . . .	125
Screens . . . . .	125
cmgr Command . . . . .	127
Getting Help . . . . .	129
Using Prompt Mode . . . . .	129
Completing Actions and Cancelling . . . . .	131
Command Line Editing within cmgr . . . . .	131
Long-Running Tasks . . . . .	132
Startup Script . . . . .	132
Entering Subcommands on the Command Line . . . . .	133
Using Script Files . . . . .	133
Creating a cmgr Script Automatically . . . . .	135
Template Scripts . . . . .	138
Invoking a Shell from within cmgr . . . . .	139
<b>6. Configuration . . . . .</b>	<b>141</b>
Preliminary Steps . . . . .	141
Verify that the Cluster chkconfig Flag is On . . . . .	142
Start the Cluster Daemons . . . . .	142
Verify that the Cluster Daemons are Running . . . . .	142
Determine the Hostname of the Node . . . . .	143
Name Restrictions . . . . .	144
Configuring Timeout Values and Monitoring Intervals . . . . .	144
Setting Configuration Defaults with cmgr . . . . .	145
Guided Configuration with the GUI . . . . .	146
Set Up a New Cluster . . . . .	147
Set Up a Highly Available Resource Group . . . . .	148

---

Set Up an Existing CXFS Cluster for FailSafe . . . . .	149
Fix or Upgrade Cluster Nodes . . . . .	150
Make Changes to Existing Cluster . . . . .	150
Optimize Node Usage . . . . .	151
Define Custom Resource . . . . .	151
Customize FailSafe Failure Detection . . . . .	152
Customize Resource Group Failover Behavior . . . . .	152
Customize Resource Failover Behavior . . . . .	153
Redistribute Resource Load in Cluster . . . . .	153
Node Tasks . . . . .	154
Define a Node . . . . .	154
Define a Node with the GUI . . . . .	154
Define a Node with <code>cmgr</code> . . . . .	158
Add or Remove Nodes in the Cluster . . . . .	164
Add or Remove Nodes in the Cluster with the GUI . . . . .	164
Modify a Node Definition . . . . .	164
Modify a Node Definition with the GUI . . . . .	164
Modify a Node Definition with <code>cmgr</code> . . . . .	167
Example of Partitioning . . . . .	167
Convert a CXFS Node to FailSafe . . . . .	169
Convert a CXFS Node to FailSafe with the GUI . . . . .	169
Convert a Node to CXFS or FailSafe with <code>cmgr</code> . . . . .	170
Delete a Node . . . . .	171
Delete a Node with the GUI . . . . .	171
Delete a Node with <code>cmgr</code> . . . . .	171
Display a Node . . . . .	173
Display a Node with the GUI . . . . .	173
Display a Node with <code>cmgr</code> . . . . .	173

Cluster Tasks . . . . .	174
Define a Cluster . . . . .	175
Define a Cluster with the GUI . . . . .	175
Define a Cluster with <code>cmgr</code> . . . . .	176
Modify a Cluster Definition . . . . .	179
Modify a Cluster Definition with the GUI . . . . .	179
Modify a Cluster Definition with <code>cmgr</code> . . . . .	180
Convert a CXFS Cluster to FailSafe . . . . .	181
Convert a CXFS Cluster to FailSafe with the GUI . . . . .	181
Converting a CXFS Cluster to Failsafe with <code>cmgr</code> . . . . .	181
Delete a Cluster . . . . .	182
Delete a Cluster with the GUI . . . . .	182
Delete a Cluster with <code>cmgr</code> . . . . .	182
Display a Cluster . . . . .	184
Display a Cluster with the GUI . . . . .	184
Display a Cluster with <code>cmgr</code> . . . . .	184
Resource Type Tasks . . . . .	185
Define a Resource Type . . . . .	185
Define a Resource Type with the GUI . . . . .	185
Define a Resource Type with <code>cmgr</code> . . . . .	188
Redefine a Resource Type for a Specific Node . . . . .	194
Redefine a Resource Type for a Specific Node with the GUI . . . . .	194
Define a Node-Specific Resource Type with <code>cmgr</code> . . . . .	198
Add/Remove Dependencies for a Resource Type . . . . .	198
Add/Remove Dependencies for a Resource Type with the GUI . . . . .	198
Add/Remove Dependencies for a Resource Type with <code>cmgr</code> . . . . .	200
Load a Resource Type . . . . .	201



---

Load a Resource Type with the GUI . . . . .	201
Load a Resource Type with <code>cmgr</code> . . . . .	201
Modify a Resource Type Definition . . . . .	201
Modify a Resource Type with the GUI . . . . .	201
Modify a Resource Type with <code>cmgr</code> . . . . .	204
Delete a Resource Type . . . . .	206
Delete a Resource Type with the GUI . . . . .	206
Delete a Resource Type with <code>cmgr</code> . . . . .	207
Display a Resource Type . . . . .	207
Display Resource Types with the GUI . . . . .	207
Display Resource Types with <code>cmgr</code> . . . . .	207
Resource Tasks . . . . .	207
Define a Resource . . . . .	208
Define a Resource with the GUI . . . . .	208
CXFS Attributes . . . . .	209
filesystem Attributes . . . . .	209
IP_address Attributes . . . . .	210
MAC_address Attributes . . . . .	211
volume Attributes . . . . .	211
XVM Attributes . . . . .	212
Define a Resource with <code>cmgr</code> . . . . .	213
Specify Resource Attributes with <code>cmgr</code> . . . . .	214
Redefine a Resource for a Specific Node . . . . .	216
Redefine a Resource for a Specific Node with the GUI . . . . .	216
Redefine a Resource for a Specific Node with <code>cmgr</code> . . . . .	217
Add/Remove Dependencies for a Resource Definition . . . . .	217
Add/Remove Dependencies for a Resource Definition with the GUI . . . . .	218

Add/Remove Dependencies for a Resource Definition with <code>cmgr</code> . . . . .	219
Modify a Resource Definition . . . . .	220
Modify a Resource Definition with the GUI . . . . .	220
Modify a Resource Definition with <code>cmgr</code> . . . . .	221
Delete a Resource . . . . .	221
Delete a Resource with the GUI . . . . .	221
Delete a Resource with <code>cmgr</code> . . . . .	222
Display a Resource . . . . .	222
Display a Resource with the GUI . . . . .	222
Display a Resource with <code>cmgr</code> . . . . .	222
Failover Policy Tasks . . . . .	223
Define a Failover Policy . . . . .	223
Define a Failover Policy with the GUI . . . . .	223
Define a Failover Policy with <code>cmgr</code> . . . . .	228
Modify a Failover Policy Definition . . . . .	229
Modify a Failover Policy Definition with the GUI . . . . .	229
Modify a Failover Policy Definition with <code>cmgr</code> . . . . .	232
Delete a Failover Policy . . . . .	232
Delete a Failover Policy with the GUI . . . . .	232
Delete a Failover Policy with <code>cmgr</code> . . . . .	233
Display a Failover Policy . . . . .	233
Display a Failover Policy with the GUI . . . . .	233
Display a Failover Policy with <code>cmgr</code> . . . . .	233
Resource Group Tasks . . . . .	234
Define a Resource Group . . . . .	234
Define a Resource Group with the GUI . . . . .	234
Define a Resource Group with <code>cmgr</code> . . . . .	235

Modify a Resource Group Definition . . . . .	236
Modify a Resource Group Definition with the GUI . . . . .	236
Modify a Resource Group Definition with <code>cmgr</code> . . . . .	236
Delete a Resource Group . . . . .	236
Delete a Resource Group with the GUI . . . . .	237
Delete a Resource Group with <code>cmgr</code> . . . . .	237
Add/Remove Resources in Resource Group . . . . .	237
Display a Resource Group . . . . .	238
Display a Resource Group with the GUI . . . . .	238
Display a Resource Group with <code>cmgr</code> . . . . .	239
FailSafe HA Services Tasks . . . . .	239
Start FailSafe HA Services . . . . .	240
Start FailSafe HA Services with the GUI . . . . .	240
Start FailSafe HA Services with <code>cmgr</code> . . . . .	240
Stop FailSafe HA Services . . . . .	241
Stop FailSafe HA Services with the GUI . . . . .	241
Stopping HA Services on One Node . . . . .	242
Stopping HA Services on All Nodes in a Cluster . . . . .	243
Stop FailSafe HA Services with <code>cmgr</code> . . . . .	243
Set FailSafe HA Parameters . . . . .	244
Set FailSafe HA Parameters with the GUI . . . . .	244
Set FailSafe HA Parameters with <code>cmgr</code> . . . . .	245
Set Log Configuration . . . . .	246
Set Log Configuration with the GUI . . . . .	246
Default Log File Names . . . . .	247
Display Log Group Definitions with the GUI . . . . .	249
Define Log Groups with <code>cmgr</code> . . . . .	249

Configure Log Groups with <code>cmgr</code> . . . . .	250
Modify Log Groups with <code>cmgr</code> . . . . .	251
Display Log Group Definitions . . . . .	252
Display Log Group Definitions with <code>cmgr</code> . . . . .	252
<b>7. Configuration Examples . . . . .</b>	<b>255</b>
Example: Script to Define an SGI File Server 850 Cluster . . . . .	255
Example: Script to Define an SGI SAN Server 1000 Cluster . . . . .	263
Example: Script to Define a Three-Node Cluster . . . . .	269
Example: Modify a Cluster to Include a CXFS Filesystem . . . . .	276
Example: Export CXFS Filesystems . . . . .	277
Example: Create a Resource Group . . . . .	278
Example: Local Failover of HA IP Address . . . . .	279
Example <code>start</code> Script Modified for Local IP Failover . . . . .	281
Example <code>restart</code> Script Modified for Local IP Failover . . . . .	283
<b>8. FailSafe System Operation . . . . .</b>	<b>291</b>
Redirecting the Console for Origin 300, Origin 3200C, Onyx 300, and Onyx 3200C . . . . .	291
Two-Node Clusters: Single-Node Use . . . . .	292
Using a Single Node . . . . .	293
Resuming Two-Node Use . . . . .	295
System Status . . . . .	297
Monitoring System Status with <code>cluster_status</code> . . . . .	298
Monitoring System Status with the GUI . . . . .	299
Key to Icons and States . . . . .	300
Querying Cluster Status with <code>cmgr</code> . . . . .	302
Monitoring Resource and Reset Serial Line with <code>cmgr</code> . . . . .	302

---

Querying Resource Status with <code>cmgr</code> . . . . .	302
Performing a ping of a System Controller with <code>cmgr</code> . . . . .	303
Resource Group Status . . . . .	303
Resource Group State . . . . .	304
Resource Group Error State . . . . .	305
Resource Owner . . . . .	306
Monitoring Resource Group Status with GUI . . . . .	306
Querying Resource Group Status with <code>cmgr</code> . . . . .	306
Node Status . . . . .	307
Monitoring Node Status with <code>cluster_status</code> . . . . .	307
Monitoring Cluster Status with the GUI . . . . .	307
Querying Node Status with <code>cmgr</code> . . . . .	307
Performing a ping of the System Controller with <code>cmgr</code> . . . . .	307
Viewing System Status with the <code>haStatus</code> Script . . . . .	308
Embedded Support Partner (ESP) Logging of FailSafe Events . . . . .	314
Resource Group Failover . . . . .	315
Bring a Resource Group Online . . . . .	315
Bring a Resource Group Online with the GUI . . . . .	316
Bring a Resource Group Online with <code>cmgr</code> . . . . .	316
Take a Resource Group Offline . . . . .	317
Take a Resource Group Offline with the GUI . . . . .	317
Take a Resource Group Offline with <code>cmgr</code> . . . . .	319
Move a Resource Group . . . . .	319
Move a Resource Group with the GUI . . . . .	319
Move a Resource Group with <code>cmgr</code> . . . . .	320
Suspend and Resume Monitoring of a Resource Group . . . . .	320
Suspend Monitoring a Resource Group with the GUI . . . . .	321

Resume Monitoring of a Resource Group with the GUI . . . . .	321
Putting a Resource Group into Maintenance Mode with <code>cmgr</code> . . . . .	322
Resume Monitoring of a Resource Group with <code>cmgr</code> . . . . .	322
Stopping FailSafe . . . . .	322
Resetting Nodes . . . . .	322
Reset a Node with the GUI . . . . .	322
Reset a Node with <code>cmgr</code> . . . . .	323
Power Cycle a Node with <code>cmgr</code> . . . . .	323
Perform an NMI on a Node with <code>cmgr</code> . . . . .	324
Cluster Database Backup and Restore . . . . .	325
Restoring the Database from Another Node . . . . .	325
Using <code>build_cmgr_script</code> for the Cluster Database . . . . .	325
Using <code>cdbBackup</code> and <code>cdbRestore</code> for the Cluster Database and Logging Information . . . . .	327
Filesystem Dump and Restore . . . . .	329
Rotating Log Files . . . . .	329
Rotating All Log Files . . . . .	329
Rotating Large Log Files . . . . .	330
Granting Task Execution Privileges to Users . . . . .	330
Grant Task Access to a User or Users . . . . .	331
Granting Access to a Few Tasks . . . . .	332
Granting Access to Most Tasks . . . . .	334
Revoke Task Access from a User or Users . . . . .	335
Updating the Checksum Version for 6.5.21 and Earlier Clusters . . . . .	336
<b>9. Testing the Configuration . . . . .</b>	<b>337</b>
Performing Diagnostic Tasks with the GUI . . . . .	337
Test Connectivity with the GUI . . . . .	337

Test Resources with the GUI . . . . .	338
Test Failover Policies with the GUI . . . . .	338
Performing Diagnostic Tasks with <code>cmgr</code> . . . . .	338
Test the Serial Connections with <code>cmgr</code> . . . . .	338
Test Network Connectivity with <code>cmgr</code> . . . . .	339
Test Resources with <code>cmgr</code> . . . . .	340
Test Logical Volumes with <code>cmgr</code> . . . . .	341
Test Filesystems with <code>cmgr</code> . . . . .	342
Test Resource Groups with <code>cmgr</code> . . . . .	343
Test Failover Policies with <code>cmgr</code> . . . . .	344
<b>10. System Recovery and Troubleshooting . . . . .</b>	<b>345</b>
Overview of System Recovery . . . . .	345
Identifying the Cluster Status . . . . .	346
Locating Problems . . . . .	347
Common Problems . . . . .	347
Timed-out Resource Monitor Script . . . . .	348
GUI Will Not Run . . . . .	348
Log Files Consume Too Much Disk Space . . . . .	349
Unable to Define a Node . . . . .	349
System is Hung . . . . .	349
You Cannot Log In . . . . .	349
Power Failure . . . . .	350
Error Messages During Remote Installation . . . . .	350
Disabling Resource Groups for Maintenance . . . . .	350
Ensuring that Resource Groups are Deallocated . . . . .	351
Checking for Exclusivity . . . . .	351
Stopping Resources Manually . . . . .	351

FailSafe Log Files . . . . .	351
FailSafe Membership and Resets . . . . .	352
FailSafe Membership and Tie-Breaker Node . . . . .	353
No Membership Formed . . . . .	354
Status Monitoring . . . . .	354
XVM Alternate Path Failover . . . . .	355
Dynamic Control of FailSafe HA Services . . . . .	356
Recovery Procedures . . . . .	357
Single-Node Recovery . . . . .	358
Cluster Error Recovery . . . . .	358
Resource Group Recovery . . . . .	359
Node Error Recovery . . . . .	359
Resource Group Maintenance and Error Recovery . . . . .	360
Clear Resource Error State . . . . .	363
Control Network Failure Recovery . . . . .	364
Serial Cable Failure Recovery . . . . .	364
Cluster Database Sync Failure . . . . .	365
Cluster Database Maintenance and Recovery . . . . .	365
GUI Will Not Run . . . . .	366
GUI and <code>cmgr</code> Inconsistencies . . . . .	367
GUI Does Not Report Information . . . . .	367
Using the <code>cdbreinit</code> Command . . . . .	368
Action Script Configuration Errors . . . . .	368
CXFS Metadata Server Relocation . . . . .	369
Other Problems with CXFS Coexecution . . . . .	369
Reporting Problems to SGI . . . . .	369
<b>11. Upgrading and Maintaining Active Clusters . . . . .</b>	<b>371</b>



Adding a Node to an Active Cluster . . . . .	371
Deleting a Node from an Active Cluster . . . . .	373
Changing Control Networks in a Cluster . . . . .	375
Upgrading OS Software in an Active Cluster . . . . .	377
Upgrading FailSafe Software in an Active Cluster . . . . .	378
Adding New Resource Groups or Resources in an Active Cluster . . . . .	379
Adding a New Hardware Device in an Active Cluster . . . . .	380
<b>12. Performance Co-Pilot for FailSafe . . . . .</b>	<b>381</b>
Using the Visualization Tools . . . . .	381
Performance Co-Pilot for FailSafe Performance Metrics . . . . .	385
Performance Co-Pilot Gray Display . . . . .	385
<b>Appendix A. FailSafe Software . . . . .</b>	<b>387</b>
Subsystems on the CD . . . . .	387
Subsystems for Servers and Workstations in the Pool . . . . .	389
Additional Subsystems for Nodes in the FailSafe Cluster . . . . .	390
Additional Subsystems for Workstations . . . . .	390
Subsystems for IRIX Workstations . . . . .	391
Subsystems for Other Operating System Workstations . . . . .	391
<b>Appendix B. Metrics Exported by Performance Co-Pilot for FailSafe . . . . .</b>	<b>393</b>
<b>Appendix C. System Messages . . . . .</b>	<b>403</b>
SYSLOG Messages . . . . .	403
Normal Messages After Successfully Starting HA Services . . . . .	405
cli Error Messages . . . . .	405
crsd Error Messages . . . . .	406

## Contents

---

cmond Error Messages . . . . .	407
fs2d Error Messages . . . . .	408
ha_srmd Error Message . . . . .	409
Log File Error Messages . . . . .	409
cad Messages . . . . .	410
cli Messages . . . . .	412
crsd Errors . . . . .	413
fs2d Errors . . . . .	414
<b>Glossary . . . . .</b>	<b>415</b>
<b>Index . . . . .</b>	<b>427</b>

---

## Figures

<b>Figure 1-1</b>	An Example CXFS and FailSafe Configuration . . . . .	3
<b>Figure 1-2</b>	Pool and Cluster Concepts . . . . .	6
<b>Figure 1-3</b>	FailSafe Membership . . . . .	9
<b>Figure 1-4</b>	Resource Type Dependencies . . . . .	13
<b>Figure 1-5</b>	Sample System Components . . . . .	17
<b>Figure 1-6</b>	Configuration Types . . . . .	20
<b>Figure 1-7</b>	Reset Types . . . . .	21
<b>Figure 1-8</b>	Disk Storage Failover in a Two-Node Cluster . . . . .	27
<b>Figure 2-1</b>	Example Configuration with Four Resource Groups . . . . .	32
<b>Figure 2-2</b>	Non-Shared Disk Configuration and Failover . . . . .	34
<b>Figure 2-3</b>	Shared Disk Configuration for Active/Backup Use . . . . .	36
<b>Figure 2-4</b>	Shared Disk Configuration for Dual-Active Use . . . . .	37
<b>Figure 2-5</b>	Example Logical Volume Configuration . . . . .	39
<b>Figure 2-6</b>	Filesystems and Logical Volumes . . . . .	46
<b>Figure 2-7</b>	Contents of a Coexecution Cluster Database . . . . .	48
<b>Figure 4-1</b>	Example Interface Configuration . . . . .	100
<b>Figure 5-1</b>	GUI Showing Details for a Resource . . . . .	126
<b>Figure 5-2</b>	Pop-up Menu that Appears After Clicking the Right Mouse Button . . . . .	127
<b>Figure 6-1</b>	Dependencies . . . . .	199
<b>Figure 6-2</b>	Example of Resource Dependency . . . . .	218
<b>Figure 6-3</b>	Mutual Dependency of Resources Is Not Allowed . . . . .	219
<b>Figure 7-1</b>	SGI File Server 850 Configuration . . . . .	256
<b>Figure 7-2</b>	Resource Dependencies for SGI File Server 850 . . . . .	258

<b>Figure 7-3</b>	SGI SAN Server Configuration . . . . .	263
<b>Figure 7-4</b>	Resource Dependencies for SGI SAN Server . . . . .	265
<b>Figure 7-5</b>	FailSafe Configuration Example . . . . .	270
<b>Figure 8-1</b>	Results of Granting a User Privilege . . . . .	333
<b>Figure 8-2</b>	Displaying the Privileged Commands a User May Execute . . . . .	334
<b>Figure 12-1</b>	Heartbeat Response Statistics . . . . .	382
<b>Figure 12-2</b>	Resource Monitoring Statistics . . . . .	383

---

## Tables

<b>Table 1-1</b>	Example webgroup Resource Group . . . . .	11
<b>Table 2-1</b>	XLV Logical Volume Resource Attributes . . . . .	39
<b>Table 2-2</b>	Local XVM Volume Resource Attributes . . . . .	40
<b>Table 2-3</b>	Filesystem Configuration Parameters . . . . .	45
<b>Table 2-4</b>	HA IP Address Configuration Parameters . . . . .	56
<b>Table 3-1</b>	FailSafe Diagnostic Test Summary . . . . .	68
<b>Table 4-1</b>	fs2d.options File Options . . . . .	95
<b>Table 4-2</b>	Performance Co-Pilot for FailSafe Collector Subsystems . . . . .	110
<b>Table 4-3</b>	Performance Co-Pilot for FailSafe Monitor Subsystems . . . . .	112
<b>Table 5-1</b>	GUI Platforms . . . . .	119
<b>Table 5-2</b>	Template Scripts for cmgr . . . . .	138
<b>Table 6-1</b>	System Controller Types . . . . .	161
<b>Table 6-2</b>	Resource Type Attributes . . . . .	215
<b>Table 6-3</b>	Failover Attributes . . . . .	225
<b>Table 6-4</b>	Log Levels . . . . .	248
<b>Table 6-5</b>	Default Log File Names . . . . .	248
<b>Table 7-1</b>	SGI File Server 850 Resources and Failover Policies for RG1 and RG2 . . . . .	257
<b>Table 7-2</b>	SGI SAN Server Resources and Failover Policies for RG1 and RG2 . . . . .	264
<b>Table 7-3</b>	Resources and Failover Policies for RG1 and RG2 . . . . .	270
<b>Table 8-1</b>	Key to Icons . . . . .	300
<b>Table 8-2</b>	Key to States . . . . .	301
<b>Table 10-1</b>	Message Levels . . . . .	351
<b>Table A-1</b>	FailSafe CD . . . . .	388
<b>Table A-2</b>	Subsystems Required for Nodes in the Pool (Servers and GUI Client(s)) . . . . .	389

<b>Table A-3</b>	Additional Subsystems Required for Nodes in the Cluster . . . . .	390
<b>Table A-4</b>	Subsystems Required for IRIX Workstations . . . . .	391
<b>Table B-1</b>	Performance Co-Pilot Metrics . . . . .	393
<b>Table C-1</b>	SYSLOG Error Message Format . . . . .	404
<b>Table C-2</b>	Log File Error Message Format . . . . .	410

---

## About This Guide

This guide describes the configuration and administration of a FailSafe highly available system.

This guide was prepared in conjunction with the IRIS FailSafe 2.1.6 release and IRIX 6.5.27.

### Audience

This guide is written for the person who administers the FailSafe system. The FailSafe administrator must be familiar with the operation of the SGI server, storage systems, XFS, and XLV or XVM.

### Assumptions

To use Performance Co-Pilot for FailSafe, you must have the following licenses:

- Two or more Performance Co-Pilot Collector licenses (PCPCOL), one for each node in the FailSafe cluster from which you want to collect performance metrics.
- One Performance Co-Pilot Monitor license (PCPMON) for the workstation that is to run the visualization tools.

### Structure of This Guide

FailSafe configuration and administration information is presented in the following chapters and appendices:

- Chapter 1, "Overview", introduces the components of the FailSafe system and explains its hardware and software architecture.
- Chapter 2, "Configuration Planning", describes how to plan the configuration of a FailSafe cluster.

- Chapter 4, "FailSafe Installation and System Preparation" describes several procedures that must be performed on nodes in a cluster to prepare them for FailSafe.
- Chapter 5, "Administration Tools", provides an overview of the FailSafe Manager GUI and the `cmgr` command.
- Chapter 6, "Configuration", explains how to configure a FailSafe system.
- Chapter 7, "Configuration Examples", shows an example of a FailSafe three-node configuration and some variations on that configuration.
- Chapter 8, "FailSafe System Operation", explains how to operate and monitor a FailSafe system.
- Chapter 9, "Testing the Configuration", describes how to test the configured FailSafe system.
- Chapter 10, "System Recovery and Troubleshooting", describes the log files used by FailSafe and recovery procedures.
- Chapter 11, "Upgrading and Maintaining Active Clusters", describes some procedures you may need to perform without shutting down a FailSafe cluster.
- Chapter 12, "Performance Co-Pilot for FailSafe", tells you how to use Performance Co-Pilot to monitor the availability of a FailSafe cluster.
- Appendix A, "FailSafe Software", summarizes the systems to install on each component of a cluster.
- Appendix B, "Metrics Exported by Performance Co-Pilot for FailSafe", lists the metrics implemented by `pmdafsafe`.

## Related Documentation

The following documentation will be useful in a FailSafe environment:

- *FailSafe Programmer's Guide for SGI Infinite Storage*
- *FailSafe Architecture for SGI InfiniteStorage*
- *Migrating from IRIS FailSafe 1.2 to IRIS FailSafe 2.1.X*
- *Performance Co-Pilot for IRIX Advanced User's and Administrator's Guide*



- *CXFS Administration Guide for SGI InfiniteStorage*
- *FailSafe DMF Administrator's Guide for SGI InfiniteStorage*
- *IRIS FailSafe 2.0 INFORMIX Administrator's Guide*
- *IRIS FailSafe 2.0 Netscape Server Administrator's Guide*
- *IRIX FailSafe NFS Administrator's Guide*
- *IRIS FailSafe 2.0 Oracle Administrator's Guide*
- *IRIS FailSafe Version 2 Samba Administrator's Guide*
- *FailSafe TMF Administrator's Guide for SGI InfiniteStorage*
- *Embedded Support Partner User Guide*
- *Personal System Administration Guide*
- *Network Load Balancing Software Administrator's Guide*

The FailSafe man pages are as follows:

- `cdbBackup`
- `cdbRestore`
- `cmgr`
- `crsd`
- `failsafe`
- `fs2d`
- `ha_cilog`
- `ha_cmsd`
- `ha_exec2`
- `ha_fsd`
- `ha_gcd`
- `ha_ifd`
- `ha_ifdadmin`

- `ha_macconfig2`
- `ha_srmd`
- `ha_statd2`
- `haStatus`

Release notes are included with each FailSafe product. The names of the release notes are as follows:

---

Release Note	Product
<code>cluster_admin</code>	Cluster administration services
<code>cluster_control</code>	Node control services
<code>cluster_services</code>	Cluster services
<code>failsafe2</code>	IRIS FailSafe 2.1.x
<code>failsafe2_dmf</code>	IRIS FailSafe for DMF
<code>failsafe2_informix</code>	IRIS FailSafe for INFORMIX
<code>failsafe2_nfs</code>	IRIS FailSafe for NFS
<code>failsafe2_oracle</code>	IRIS FailSafe for Oracle
<code>failsafe2_samba</code>	IRIS FailSafe for Samba
<code>failsafe2_tmf</code>	IRIS FailSafe for TMF

---

## Obtaining Publications

You can obtain SGI documentation as follows:

- See the SGI Technical Publications Library at <http://docs.sgi.com>. Various formats are available. This library contains the most recent and most comprehensive set of online books, release notes, man pages, and other information.
- If it is installed on your SGI system, you can use InfoSearch, an online tool that provides a more limited set of online books, release notes, and man pages. With an IRIX system, enter `infosearch` at a command line or select **Help > InfoSearch** from the Toolchest.

- On IRIX systems, you can view release notes by entering either `grelnotes` or `relnotes` at a command line.
- On Linux systems, you can view release notes on your system by accessing the `README.txt` file for the product. This is usually located in the `/usr/share/doc/productname` directory, although file locations may vary.
- You can view man pages by typing `man title` at a command line.

## Conventions

The following conventions are used throughout this document:

Convention	Meaning
<code>command</code>	This fixed-space font denotes literal items such as commands, files, routines, path names, signals, messages, and programming language structures.
<code>manpage(x)</code>	Man page section identifiers appear in parentheses after man page names. (1) indicates a user command, (1M) and (8) indicate an administrator command
<i>variable</i>	Italic typeface denotes variable entries and words or concepts being defined.
<b>GUI</b>	This font denotes the names of graphical user interface (GUI) elements such as windows, screens, dialog boxes, menus, toolbars, icons, buttons, boxes, fields, and lists.
<b>user input</b>	This bold, fixed-space font denotes literal items that the user enters in interactive sessions. (Output is shown in nonbold, fixed-space font.)
[ ]	Brackets enclose optional portions of a command or directive line.

...

Ellipses indicate that a preceding element can be repeated.

## Reader Comments

If you have comments about the technical accuracy, content, or organization of this publication, contact SGI. Be sure to include the title and document number of the publication with your comments. (Online, the document number is located in the front matter of the publication. In printed publications, the document number is located at the bottom of each page.)

You can contact SGI in any of the following ways:

- Send e-mail to the following address:  
techpubs@sgi.com
- Use the Feedback option on the Technical Publications Library Web page:  
<http://docs.sgi.com>
- Contact your customer service representative and ask that an incident be filed in the SGI incident tracking system.
- Send mail to the following address:  
Technical Publications  
SGI  
1500 Crittenden Lane, M/S 535  
Mountain View, California 94043-1351

SGI values your comments and will respond to them promptly.

## Overview

This chapter provides an overview of the components and operation of the FailSafe system. It contains the following:

- "High Availability with FailSafe"
- "Complete Storage Solution: FailSafe, CXFS, DMF, and TMF" on page 2
- "Cluster Environment" on page 4
- "Additional Features" on page 22
- "Administration" on page 23
- "Highly Available Resources" on page 24
- "Highly Available Applications" on page 28
- "Failover and Recovery Processes" on page 28
- "Overview of Configuring and Testing a New Cluster" on page 29
- "Release Support Policy" on page 30

### High Availability with FailSafe

FailSafe provides a general facility for providing *highly available services*. This type of system survives a single point of failure by using redundant components and FailSafe software to provide highly available services for a cluster that contains multiple nodes.

If one of the nodes in the cluster or one of the nodes' components fails, a different node in the cluster restarts the highly available services of the failed node. To clients, the services on the replacement node are indistinguishable from the original services before failure occurred. It appears as if the original node has crashed and rebooted quickly. The clients notice only a brief interruption in the highly available service.

In a FailSafe environment, nodes can serve as backup systems for other nodes. Unlike the backup resources in a fault-tolerant system, which serve purely as redundant hardware for backup in case of failure, the resources of each node in a highly available system can be used during normal operation to run other applications that

are not necessarily highly available services. All highly available services are owned by one node in the cluster at a time.

Highly available services are monitored by the FailSafe software. If a failure is detected on any of these components, a *failover* process is initiated. Using FailSafe, you can define a failover policy to establish which node will take over the services under what conditions. This process consists of resetting the failed node (to ensure data consistency), performing recovery procedures required by the failed over services, and quickly restarting the services on the node that will take them over.

FailSafe also supports *selective failover* in which individual highly available applications can be failed over to a backup node independent of the other highly available applications on that node.

## Complete Storage Solution: FailSafe, CXFS, DMF, and TMF

The FailSafe, CXFS, DMF, and TMF products are integrated to provide a complete storage solution.

### CXFS

CXFS, the clustered XFS filesystem, allows groups of computers to coherently share large amounts of data while maintaining high performance. You can use FailSafe to provide highly available services (such as NFS or Web) running on a CXFS filesystem. This combination provides high-performance shared data access for highly available applications.

Figure 1-1 shows an example configuration.

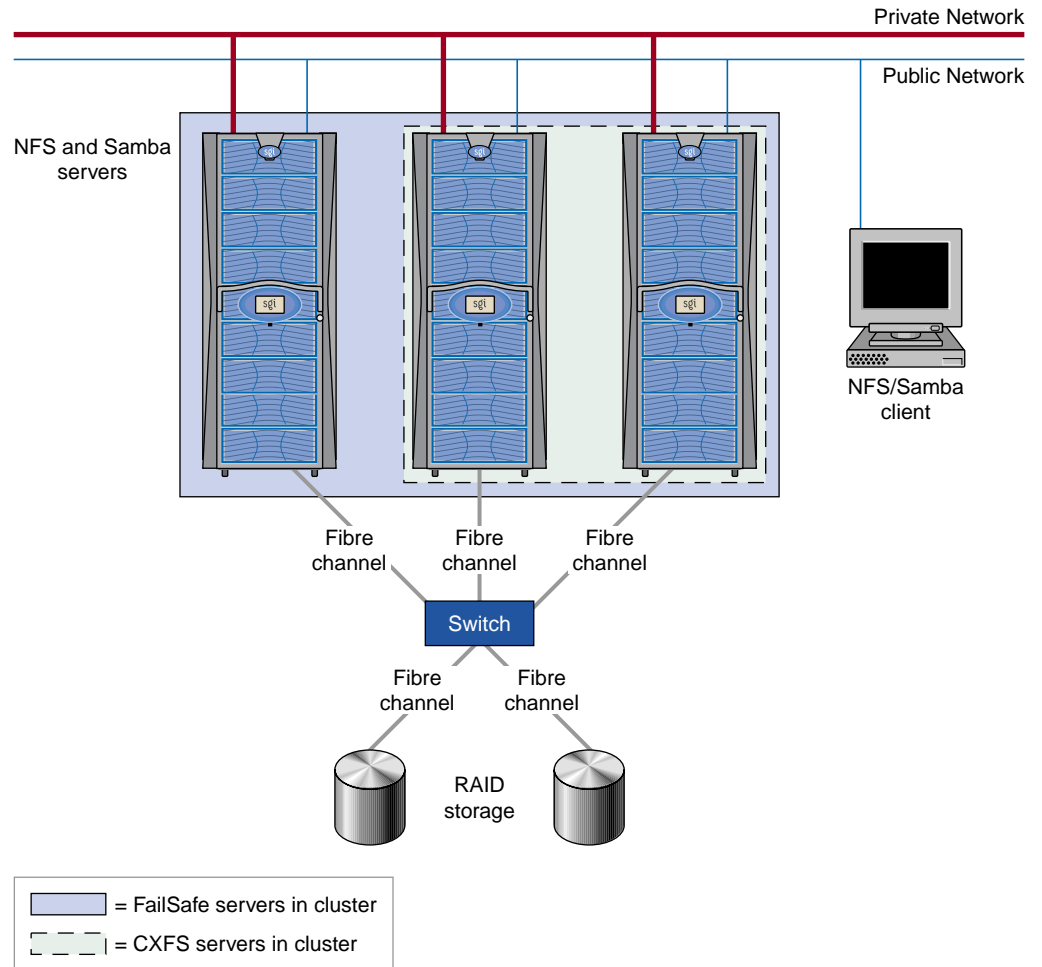

**Figure 1-1** An Example CXFS and FailSafe Configuration

For more information, see the *CXFS Administration Guide for SGI InfiniteStorage* and the *CXFS MultiOS Client-Only Guide for SGI InfiniteStorage*.

## DMF

The Data Migration Facility (DMF) is a hierarchical storage management system for SGI environments. Its primary purpose is to preserve the economic value of storage media and stored data. The high I/O bandwidth of these environments is sufficient to overrun online disk resources. Consequently, capacity scheduling, in the form of native file system migration, has become an integral part of many computing environments and is a requirement for effective use of SGI systems.

The FailSafe DMF plug-in enables DMF and its resources to be moved from one server to another when a FailSafe failover occurs. If the server that is running FailSafe DMF crashes, DMF fails over to another server along with its filesystems.

For more information, see the *FailSafe DMF Administrator's Guide for SGI InfiniteStorage*.

## TMF

The Tape Management Facility (TMF) supports processing of labeled tapes, including multivolume volumes and multivolume sets. These capabilities are most important to customers who run production tape operations where tape label recognition and tape security are requirements.

The FailSafe TMF plug-in enables TMF and its resources to be failed over from one server to another when a failure occurs.

For more information, see the *FailSafe TMF Administrator's Guide for SGI InfiniteStorage*.

## Cluster Environment

This section discusses the following:

- "Terminology" on page 5
- "Hardware Components" on page 17
- "Disk Connections" on page 19
- "Supported Configurations" on page 19



## Terminology

This section defines the terminology necessary to configure and monitor highly available services with FailSafe.

### Cluster

A *cluster* is the set of systems (nodes) configured to work together as a single computing resource. A cluster is identified by a simple name and a cluster ID. There is only one cluster that may be formed from a given pool of nodes.

Disks or logical units (LUNs) are assigned to clusters by recording the name of the cluster on the disk or LUN. Thus, if any disk is accessible (via a Fibre Channel connection) from machines in multiple clusters, then those clusters must have unique names. When members of a cluster send messages to each other, they identify their cluster via the cluster ID.

You should choose unique names and cluster IDs for each of the clusters within your organization.

### Node

A *node* is an operating system (OS) image, usually an individual computer. (This use of the term *node* does not have the same meaning as a node in an SGI Origin 3000 or SGI 2000 system.) A given node can be a member of only one pool and therefore only one cluster.

### Pool

The *pool* is the set of nodes from which a particular cluster may be formed. Only one cluster may be configured from a given pool, and it need not contain all of the available nodes. (Other pools may exist, but each is disjoint from the other. They share no node or cluster definitions.)

A pool is formed when you connect to a given node and define that node in the cluster database using the FailSafe graphical user interface (GUI) or `cmgr` command. You can then add other nodes to the pool by defining them while still connected to the first node, or to any other node that is already in the pool. (If you were to connect to another node and then define it, you would be creating a second pool).

Figure 1-2 shows the concepts of pool and cluster.

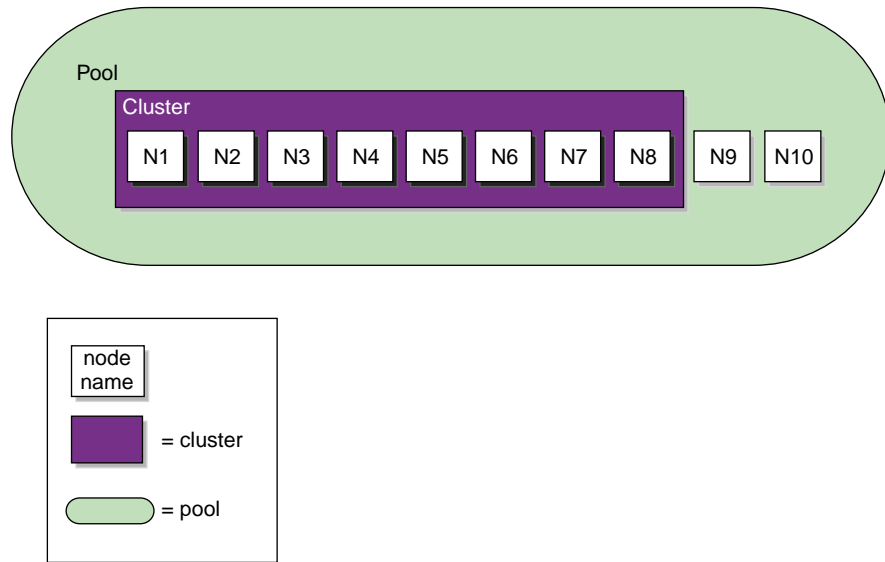

**Figure 1-2** Pool and Cluster Concepts

### Cluster Database

The *cluster database* contains configuration information about resources, resource groups, failover policy, nodes, clusters, logging information, and configuration parameters.

The database consists of a collection of files; you can view and modify the contents of the database by using the FailSafe Manager GUI and the `cmgr`, `cluster_status`, and `clconf_info` commands.

If you are running FailSafe in coexecution with CXFS, they share the same cluster database and command-line interface commands. However, each product has its own GUI.

## Membership

There are the following types of membership:

- *FailSafe membership* is the list of FailSafe nodes in the **cluster** on which FailSafe can make resource groups online:
  - The *potential* FailSafe membership is the set of all FailSafe nodes that are defined in the cluster and on which HA services have been enabled. Nodes are enabled when HA services are started. The enabled status is stored in the cluster database; if an enabled node goes down, its status will remain enabled to indicate that it is supposed to be in the membership.
  - The *actual* membership consists of the eligible nodes whose state is known and that are communicating with other FailSafe nodes using multiple heartbeat and control networks. If the highest priority private network is unavailable, the FailSafe heartbeat will fail over to the next available heartbeat network defined for the node.

Stopping HA services on a node (deactivating the node) is equivalent to removing a node from the FailSafe cluster. FailSafe membership does not include deactivated nodes in membership calculation.

- *Cluster database membership* (also known as *fs2d membership*) is the group of nodes in the **pool** where the cluster database is replicated. The `fs2d` daemon is the cluster database daemon that maintains membership of nodes where the database is replicated and keeps the database synchronized across database transactions.

For more details about membership, see *FailSafe Architecture for SGI InfiniteStorage*.

With CXFS coexecution, there is also *CXFS membership*. For more information about CXFS, see "Coexecution of CXFS and FailSafe" on page 47, and the *CXFS Administration Guide for SGI InfiniteStorage*.

## Quorum

The *quorum* is the number of nodes required to form a cluster, which differs according to membership:

- For FailSafe membership: >50% (a majority) of the nodes in the cluster where highly available (HA) services were started must be in a known state (successfully reset or talking to each other using heartbeat and control networks) to form and maintain a cluster.

- For cluster database membership, **50%** (half) of the **nodes in the pool** must be available to the `fs2d` daemon (and can therefore receive cluster database updates) to form and maintain a cluster.

Figure 1-3 shows an example of FailSafe and cluster database memberships. The figure describes the following:

- A pool consisting of six nodes, N1 through N6.
- A cluster that has been defined to have four nodes, N1 to N4.
- HA services have been started on four nodes, N1 to N4. (HA services can only be started on nodes that have been defined as part of the cluster; however, not all nodes within the cluster must have HA services started.)
- Three nodes are up (N1 through N3) and three nodes are down (N4 through N6).
- The cluster database membership consists of N1 through N3, three of six nodes in the pool (50%).
- The FailSafe membership also consists of nodes N1 through N3, three of four nodes where HA services were started.

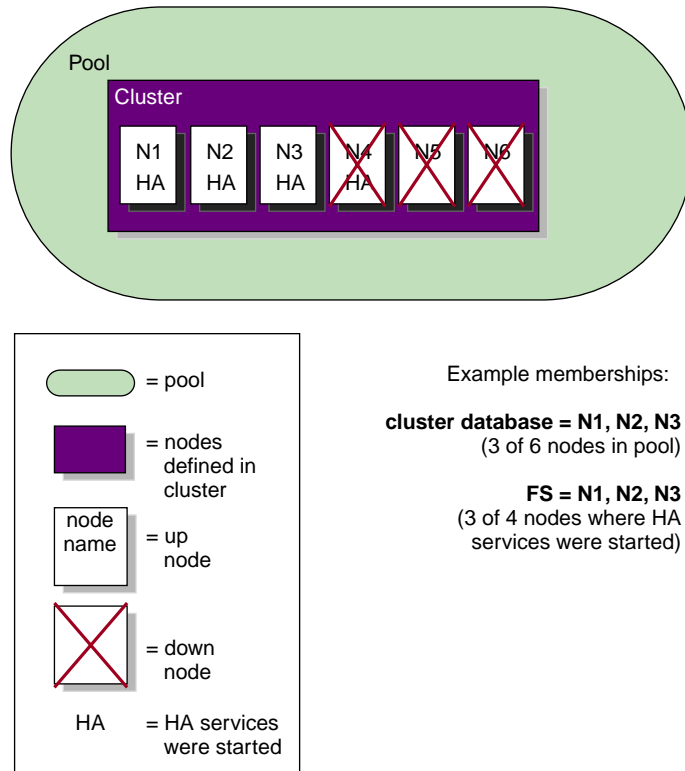

**Figure 1-3** FailSafe Membership

If a network partition results in a tied membership, in which there are two sets of nodes each consisting of 50% of the cluster, a node from the set containing the tiebreaker node will attempt to reset a node in the other set in order to maintain a quorum. For more information, see *FailSafe Architecture for SGI InfiniteStorage*.

### Private Network

A *private network* is one that is **dedicated** to cluster communication and is accessible by administrators but not by users.

The cluster software uses the private network to send the heartbeat/control messages necessary for the cluster configuration to function. If there are delays in receiving

heartbeat messages, the cluster software may determine that a node is not responding and will therefore remove it from the FailSafe membership.

Using a private network limits the traffic on the public network and therefore will help avoid unnecessary resets or disconnects.

The messaging protocol does not prevent snooping (viewing) or spoofing (in which one machine on the network masquerades as another); therefore, a private network is safer than a public network.

Therefore, because the performance and security characteristics of a public network could cause problems in the cluster and because heartbeat is very timing-dependent (even small variations can cause problems), SGI recommends a dedicated private network to which all nodes are attached and over which heartbeat/control messages are sent.

In addition, SGI recommends that all nodes be on the same local network segment.

---

**Note:** If there are any network issues on the private network, fix them before trying to use FailSafe.

---

If you are running FailSafe in coexecution with CXFS, they use the same private network. (A private network is recommended for FailSafe, but is *required* for CXFS.) You can use multiple private networks.

## Resource

A *resource* is a single physical or logical entity that provides a service to clients or other resources. For example, a resource can be a single disk volume, a particular network address, or an application such as a Web server. A resource is generally available for use over time on two or more nodes in a cluster, although it can be allocated to only one node at any given time.

Resources are identified by a resource name and a resource type.

## Resource Type

A *resource type* is a particular class of resource. All of the resources in a particular resource type can be handled in the same way for the purposes of failover. Every resource is an instance of exactly one resource type.

A resource type is identified by a simple name; this name must be unique within the cluster. A resource type can be defined for a specific node or it can be defined for an entire cluster. A resource type that is defined for a specific node overrides a clusterwide resource type definition with the same name; this allows an individual node to override global settings from a clusterwide resource type definition.

The FailSafe software includes many predefined resource types. If these types fit the application you want to make highly available, you can reuse them. If none fit, you can create additional resource types by using the instructions in the *FailSafe Programmer's Guide for SGI Infinite Storage*.

### Resource Name

A *resource name* identifies a specific instance of a resource type. A resource name must be unique for a given resource type.

### Resource Group

A *resource group* is a collection of interdependent resources. A resource group is identified by a simple name; this name must be unique within a cluster. Table 1-1 shows an example of the resources and their corresponding resource types for a resource group named Webgroup.

**Table 1-1** Example Webgroup Resource Group

Resource	Resource Type
10.10.48.22	IP_address
/fs1	filesystem
vol1	volume
web1	Netscape_web

If any individual resource in a resource group becomes unavailable for its intended use, then the entire resource group is considered unavailable. Therefore, a resource group is the unit of failover.

Resource groups cannot overlap; that is, two resource groups cannot contain the same resource.

## Dependency

One resource can be dependent on one or more other resources; if so, it will not be able to start (that is, be made available for use) unless the dependent resources are also started. Dependent resources must be part of the same resource group and are identified in a *resource dependency list*. Resource dependencies are verified when resources are added to a resource group, not when resources are defined.

---

**Note:** All interdependent resources must be added to the same resource group.

---

Like resources, a resource type can be dependent on one or more other resource types. If such a dependency exists, at least one instance of each of the dependent resource types must be defined. A *resource type dependency list* details the resource types upon which a resource type depends.

For example, a resource type named `Netscape_web` might have resource type dependencies on resource types named `IP_address` and `volume`. If a resource named `WS1` is defined with the `Netscape_web` resource type, then the resource group containing `WS1` must also contain at least one resource of the type `IP_address` and one resource of the type `volume`. This is shown in Figure 1-4.



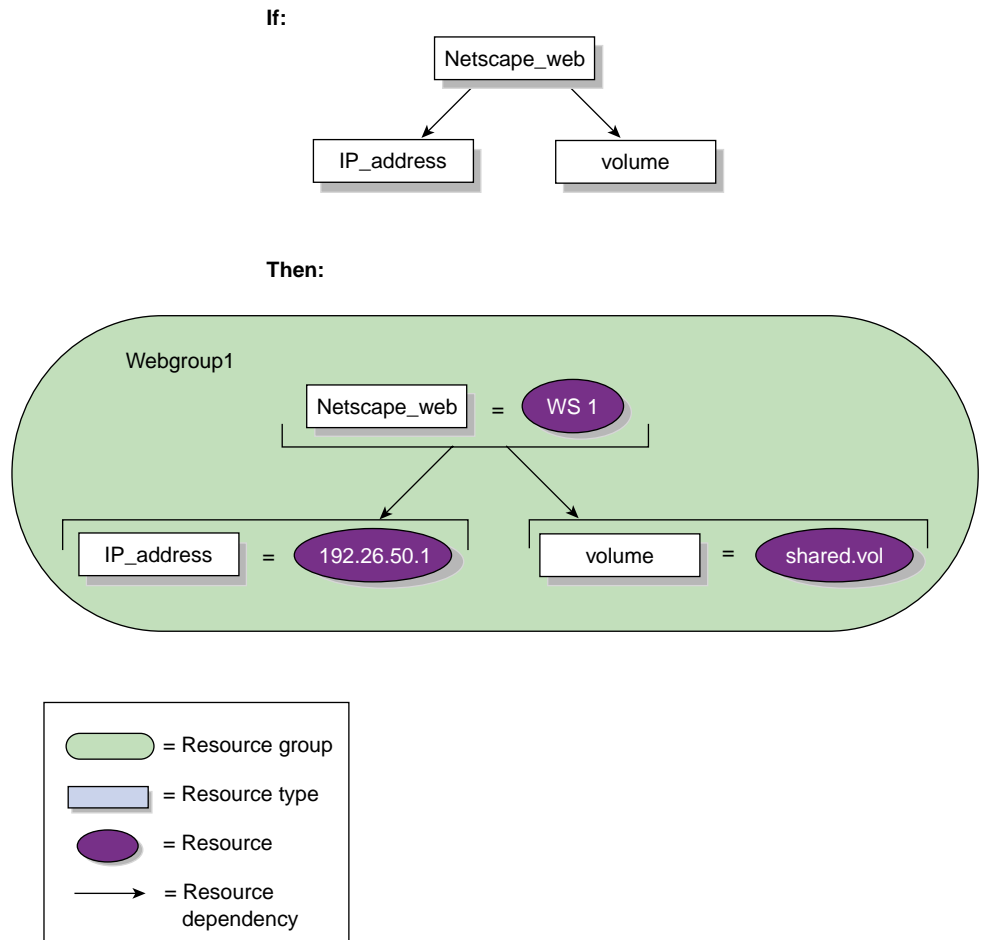

**Figure 1-4** Resource Type Dependencies

### Failover

A *failover* is the process of allocating a resource group (or application) to another node, according to a failover policy. A failover may be triggered by the failure of a resource, a change in the FailSafe membership (such as when a node fails or starts), or a manual request by the administrator.

## Failover Policy

A *failover policy* is the method used by FailSafe to determine the destination node of a failover. A failover policy consists of the following:

- Failover domain
- Failover attributes
- Failover script

FailSafe uses the failover domain output from a failover script along with failover attributes to determine on which node a resource group should reside.

The administrator must configure a failover policy for each resource group. A failover policy name must be unique within the pool.

## Failover Domain

A *failover domain* is the ordered list of nodes on which a given resource group can be allocated. The nodes listed in the failover domain must be within the same cluster; however, the failover domain does not have to include every node in the cluster.

The administrator defines the *initial failover domain* when creating a failover policy. This list is transformed into a *run-time failover domain* by the failover script; FailSafe uses the run-time failover domain along with failover attributes and the FailSafe membership to determine the node on which a resource group should reside. FailSafe stores the run-time failover domain and uses it as input to the next failover script invocation. Depending on the run-time conditions and contents of the failover script, the initial and run-time failover domains may be identical.

In general, FailSafe allocates a given resource group to the first node listed in the run-time failover domain that is also in the FailSafe membership; the point at which this allocation takes place is affected by the failover attributes.

## Failover Attribute

A *failover attribute* is a string that affects the allocation of a resource group in a cluster. The administrator must specify system attributes (such as `Auto_Failback` or `Controlled_Failback`), and can optionally supply site-specific attributes.

## Failover Scripts

A *failover script* is a shell script that generates a run-time failover domain and returns it to the `ha_fsd` process. The `ha_fsd` process applies the failover attributes and then selects the first node in the returned failover domain that is also in the current FailSafe membership.

The following failover scripts are provided with the FailSafe release:

- `ordered`, which never changes the initial failover domain. When using this script, the initial and run-time failover domains are equivalent.
- `round-robin`, which selects the resource group owner in a round-robin (circular) fashion. This policy can be used for resource groups that can be run in any node in the cluster.

If these scripts do not meet your needs, you can create a new failover script using the information provided in the *FailSafe Programmer's Guide for SGI Infinite Storage*.

## Action Scripts

The *action scripts* determine how a resource is started, monitored, and stopped. There must be a set of action scripts specified for each resource type.

Following is the complete set of action scripts that can be specified for each resource type:

- `exclusive` verifies that a resource is not already running
- `start` starts a resource
- `stop` stops a resource
- `monitor` monitors a resource
- `restart` restarts a resource on the same server after a monitoring failure occurs

The release includes action scripts for predefined resource types. If these scripts fit the resource type that you want to make highly available, you can reuse them by copying them and modifying them as needed. If none fits, you can create additional action scripts by using the instructions provided in the *FailSafe Programmer's Guide for SGI Infinite Storage*.

### Cluster Process Group

A *cluster process group* is a group of application instances in a distributed application that cooperate to provide a service. Each application instance can consist of one or more operating system processes and spans only one node.

For example, distributed lock manager instances in each node would form a process group. By forming a process group, they can obtain process membership and reliable, ordered, atomic communication services.

---

**Note:** There is no relationship between an operating system process group and a cluster process group.

---

### Plug-In

A *plug-in* is the set of software required to make an application highly available, including a resource type and action scripts. There are plug-ins provided with the base FailSafe release, optional plug-ins available for purchase from SGI, and customized plug-ins you can write using the instructions in the *FailSafe Programmer's Guide for SGI Infinite Storage*.

## Hardware Components

Figure 1-5 shows an example of FailSafe hardware components, in this case for a two-node system.

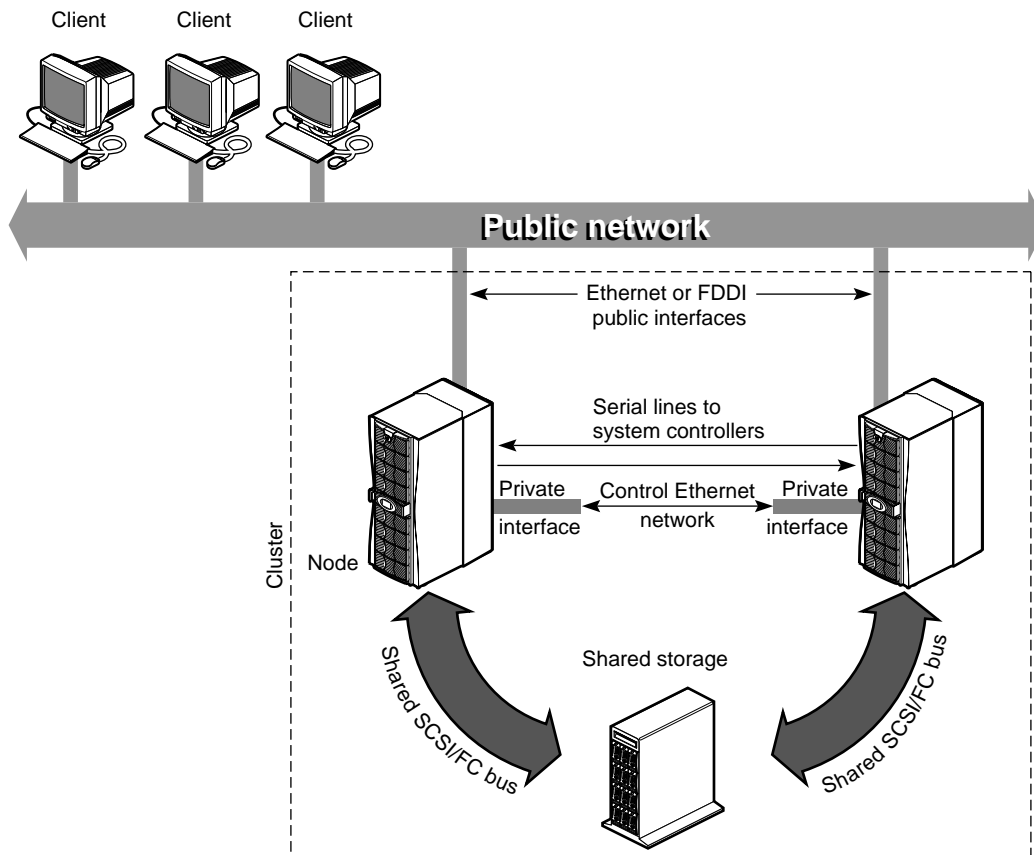

**Figure 1-5** Sample System Components

The hardware components are as follows:

- Up to eight nodes: Origin 300 and Origin 3000 series, Onyx 300 and Onyx 3000 series, Origin 200, Onyx2 deskside, SGI 2000 series, and Onyx2.
- More than two interfaces on each node for control networks.

At least two Ethernet or FDDI interfaces on each node are required for the control network *heartbeat* connection, by which each node monitors the state of other nodes. The FailSafe software also uses this connection to pass *control* messages between nodes. These interfaces have distinct IP addresses.

- A serial line from a serial port on each node to a Remote System Control port on another node.

A node that is taking over services on the failed node uses this line to reboot the failed node during takeover. This procedure ensures that the failed node is not using the shared disks when the replacement node takes them over.

- An optional Etherlite network-based serial multiplexer (EL-16) (FAILSAFE-N\_NODE) hardware component to reset machines in a cluster.
- Disk storage and SCSI bus/Fibre Channel shared by the nodes in the cluster.

The nodes in the FailSafe system share multi-hosted disk storage over a shared fast and wide SCSI bus or Fibre Channel. The storage connection is shared so that either node can take over the disks in case of failure. The hardware required for the disk storage can be one of the following:

- Origin SCSI JBOD/RAID
- Origin FC RAID deskside or rackmount storage systems; each chassis assembly has two storage-control processors (SPs) and at least five disk modules with caching enabled
- TP9100
- TP9400
- TP9500

For an exact list of storage supported, please contact SGI support.

In addition, FailSafe supports ATM LAN emulation failover when FORE Systems ATM cards are used with a FORE Systems switch.

---

**Note:** The FailSafe system is designed to survive a single point of failure. Therefore, when a system component fails, it must be restarted, repaired, or replaced as soon as possible to avoid the possibility of two or more failed components.

---

## Disk Connections

A FailSafe system supports the following disk connections:

- RAID support
  - Single or dual controllers
  - Single or dual hubs
  - Single or dual pathing
- JBOD support
  - Single or dual vaults
  - Single or dual hubs

SCSI disks can be connected to two machines only. Fibre Channel disks can be connected to multiple machines.

## Supported Configurations

FailSafe supports the following highly available configurations:

- Basic two-node configuration
- Star configuration of multiple primary and one backup node
- Ring configuration

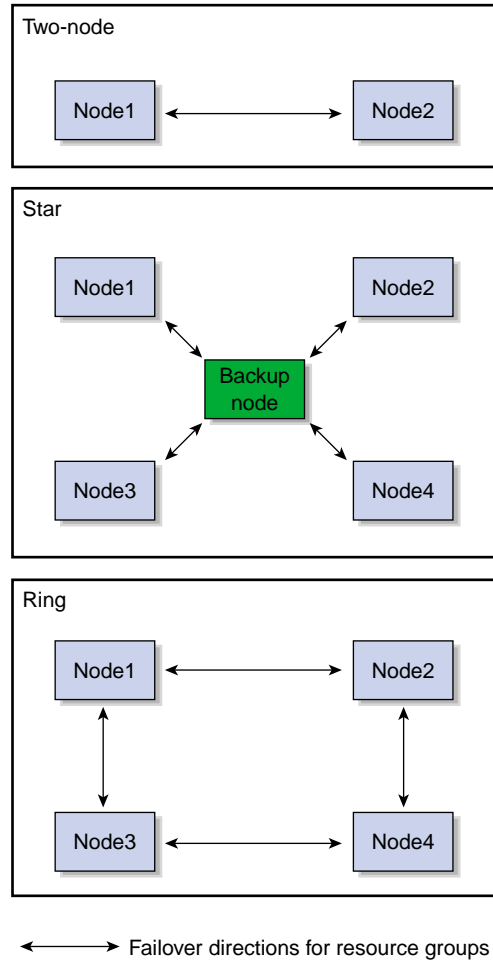

**Figure 1-6** Configuration Types

These configurations provide redundancy of processors and I/O controllers. Redundancy of storage is obtained through the use of multihosted RAID disk devices and plexed (mirrored) disks.

You can use the following reset models when configuring a FailSafe system:

- Server-to-server. Each server is directly connected to another for reset. May be unidirectional.



- Network. Each server can reset any other by sending a signal over the control network to an EL-16 multiplexer.

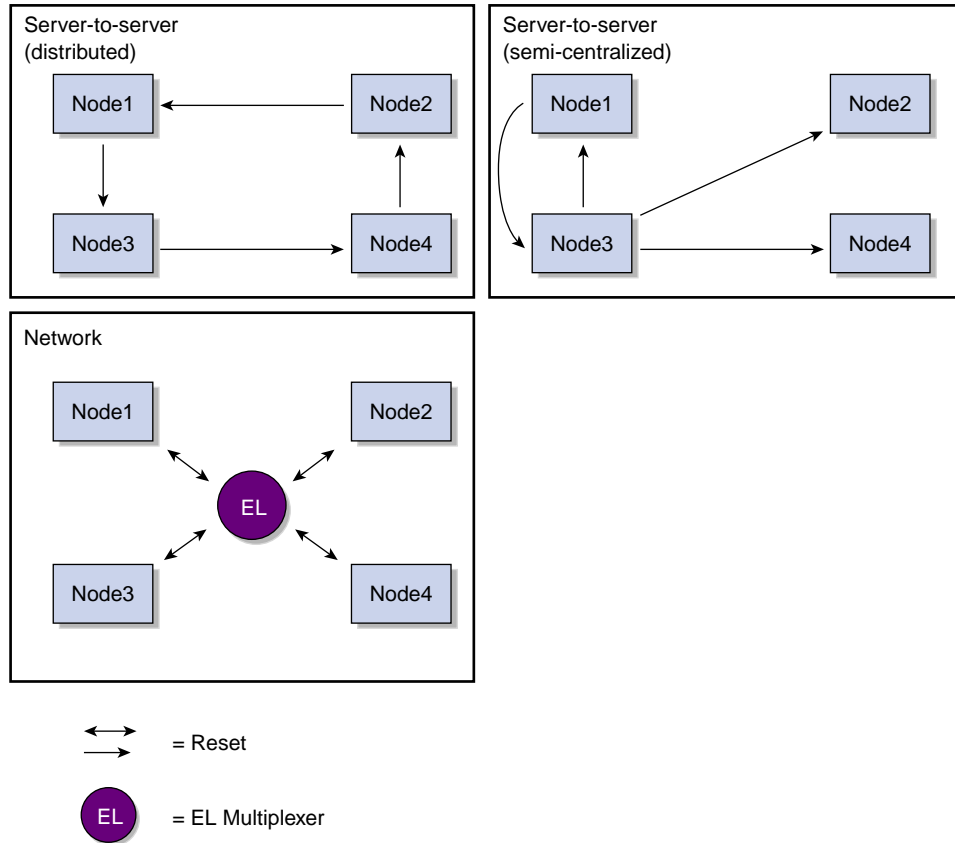

**Figure 1-7** Reset Types

In a basic two-node configuration, the following arrangements are possible:

- All highly available services run on one node. The other node is the backup node. After failover, the services run on the backup node. In this case, the backup node is a hot standby for failover purposes only. The backup node can run other applications that are not highly available services.
- Highly available services run concurrently on both nodes. For each service, the other node serves as a backup node. For example, both nodes can be exporting different NFS filesystems. If a failover occurs, one node then exports all of the NFS filesystems.

## Additional Features

FailSafe provides the following features to increase the flexibility and ease of operation of a highly available system:

- "Dynamic Management"
- "Fine-Grain Failover" on page 22
- "Local Restarts" on page 23

## Dynamic Management

FailSafe allows you to perform a variety of administrative tasks while the system is running:

- **Monitor applications.** You can turn monitoring of an application on and off while FailSafe continues to run. This allows you to perform online application upgrades without bringing down the FailSafe system.
- **Managed resources.** You can add resources while the FailSafe system is online.
- **Upgrade FailSafe software.** You can upgrade FailSafe software on one node at a time without taking down the entire FailSafe cluster.

## Fine-Grain Failover

The unit of failover is a resource group. This limits the impact of a component failure to the resource group to which that component belongs, and does not affect other

resource groups or services on the same node. The process in which a specific resource group is failed over from one node to another node while other resource groups continue to run on the first node is called *fine-grain failover*.

## Local Restarts

FailSafe allows you to fail over a resource group onto the same node. This feature enables you to configure a single-node system, where backup for a particular application is provided on the same machine, if possible. It also enables you to indicate that a specified number of local restarts be attempted before the resource group fails over to a different node.

## Administration

You can perform all FailSafe administrative tasks by means of the FailSafe Manager graphical user interface (GUI). The GUI provides a guided interface to configure, administer, and monitor a FailSafe-controlled highly available cluster. The GUI also provides screen-by-screen help text.

If you want, you can perform administrative tasks directly by using the `cmgr` command, which provides a command-line interface for the administration tasks.

For more information, see the following:

- Chapter 5, "Administration Tools" on page 117
- Chapter 6, "Configuration" on page 141
- Chapter 8, "FailSafe System Operation" on page 291

---

**Note:** Both FailSafe and CXFS use the same command line administration tool, `cmgr`. All configuration information for both products is stored in the same cluster database. However, each product has its own GUI.

---

## Highly Available Resources

This section discusses the highly available resources in a FailSafe system:

- "Nodes"
- "Network Interfaces and IP Addresses"
- "Disks" on page 26

### Nodes

FailSafe detects if a node crashes or hangs (for example, due to a parity error or bus error). A different node, determined by the failover policy, resets the failed node and takes over the failed node's services.

If a node fails, its interfaces, access to storage, and services also become unavailable. See the following sections for descriptions of how the FailSafe system handles or eliminates these points of failure.

### Network Interfaces and IP Addresses

Clients access the highly available services provided by the FailSafe cluster using IP addresses. Each highly available service can use multiple IP addresses. The IP addresses are not tied to a particular highly available service; they can be shared by all the resources in a resource group.

FailSafe uses the IP aliasing mechanism to support multiple IP addresses on a single network interface. Clients can use a highly available service that uses multiple IP addresses even when there is only one network interface in the server node.

The IP aliasing mechanism allows a FailSafe configuration that has a node with multiple network interfaces to be backed up by a node with a single network interface. IP addresses configured on multiple network interfaces are moved to the single interface on the other node in case of a failure.

---

**Note:** That is, the hostname is bound to a different IP address that never moves.

---

FailSafe requires that each network interface in a cluster have an IP address that does not fail over. These IP addresses, called *fixed IP addresses*, are used to monitor network interfaces. The fixed IP address would be the same address you would use if you

configured it as a normal system and put it on the network before FailSafe was even installed.

Each fixed IP address must be configured to a network interface at system boot up time. All other IP addresses in the cluster are configured as *highly available (HA) IP addresses*.

Highly available IP addresses are configured on a network interface. During failover and recovery processes, FailSafe moves them to another network interface in the other node. Highly available IP addresses are specified when you configure the FailSafe system. FailSafe uses the `ifconfig` command to configure an IP address on a network interface and to move IP addresses from one interface to another.

In some networking implementations, IP addresses cannot be moved from one interface to another by using only the `ifconfig` command. FailSafe uses media access control (MAC) address impersonation (*re-MACing*) to support these networking implementations.

Re-MACing moves the physical MAC address of a network interface to another interface. This is done by using the `macconfig` command. Re-MACing is done in addition to the standard `ifconfig` process that FailSafe uses to move IP addresses. This requires two network connections into the public network for each MAC address. For each MAC address being moved, a dedicated backup network interface is required. To do re-MACing in FailSafe, a resource of type `MAC_Address` is used.

---

**Note:** Re-MACing can be used only on Ethernet networks. It is usually not required for TCP/IP networks.

---

Re-MACing is required when packets called *gratuitous ARP packets* are not passed through the network. These packets are generated automatically when an IP address is added to an interface (as in a failover process). They announce a new mapping of an IP address to a MAC address. This tells clients on the local subnet that a particular interface now has a particular IP address. Clients then update their internal ARP caches with the new MAC address for the IP address. (The IP address just moved from interface to interface.) When gratuitous ARP packets are not passed through the network, the internal ARP caches of subnet clients cannot be updated. In these cases, re-MACing is used. This moves the MAC address of the original interface to the new interface. Thus, both the IP address and the MAC address are moved to the new interface and the internal ARP caches of clients do not need updating.

Re-MACing is not done by default; you must specify that it be done for each pair of primary and secondary interfaces that requires it. (See "Determining if Re-MACing is

Required" on page 55.) In general, routers and PC/NFS clients may require re-MACing interfaces.

A side effect of re-MACing is that the original MAC address of an interface that has received a new MAC address is no longer available for use. Because of this, each network interface has to be backed up by a dedicated backup interface. This backup interface cannot be used by clients as a primary interface. (After a failover to this interface, packets sent to the original MAC address are ignored by every node on the network.) Each backup interface backs up only one network interface.

---

**Note:** FailSafe treats network load balancing software (NLBS) virtual network interfaces similar to physical interfaces and allows IP aliases to be failed over on these interfaces. For more information about NLBS, see the *Network Load Balancing Software Administrator's Guide*.

---

## Disks

FailSafe supports storage based on SCSI or Fibre Channel.

Plexing must be used to mirror disks in a JBOD configuration. If highly available applications use filesystems, XFS filesystems or CXFS filesystems must be used. When CXFS filesystems are used, they must be on XVM volumes.

---

**Note:** Neither SCSI storage nor Fibre JBOD is supported in a storage area network (SAN) configuration and therefore it cannot be used with CXFS.

---

The storage components should not have a single point of failure. All data should be in a RAID or should be mirrored. It is recommended that there are at least two paths from storage to the servers for redundancy.

For Fibre Channel RAID storage systems, if a disk or disk controller fails, the RAID storage system is equipped to keep services available through its own capabilities.

For all the above storage systems, if a disk or disk controller fails, either XLV or XVM will keep the service available through a redundant path as appropriate.

If no alternate paths are available to the storage subsystems, then FailSafe will initiate a failover process.

Figure 1-8 shows an example of disk storage failover in a two-node cluster.

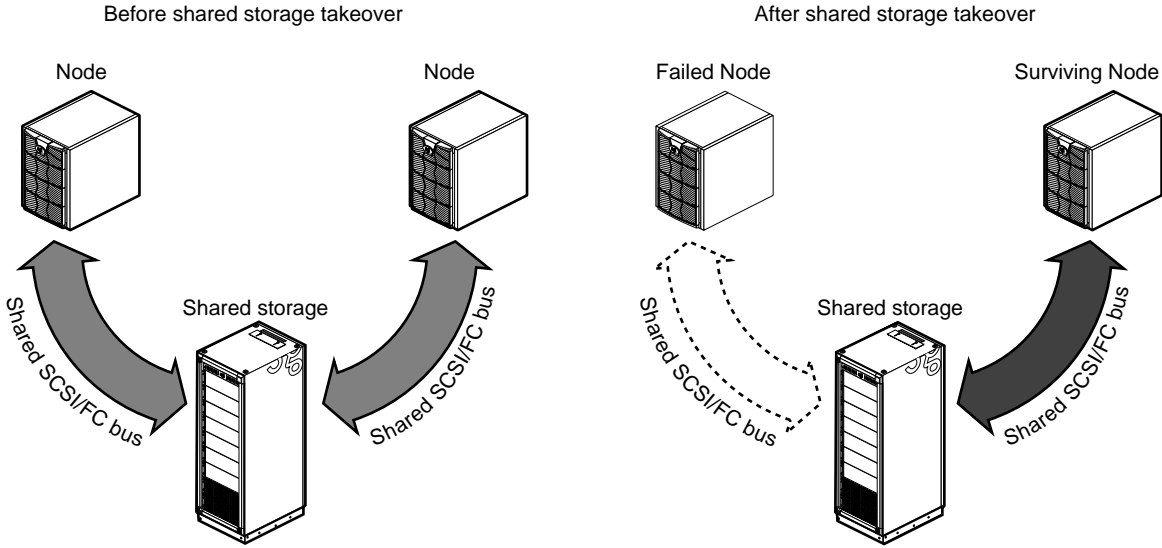

Figure 1-8 Disk Storage Failover in a Two-Node Cluster

## Highly Available Applications

Each application has a primary node and up to seven additional nodes that you can use as a backup node, according to the failover policy you define. The primary node is the node on which the application runs when FailSafe is in a *normal state*. When a failure of any highly available application is detected by FailSafe software, all resources in the affected resource group on the failed node are failed over to a different node and the resources on the failed node are stopped. When these operations are complete, the resources are started on the backup node.

All information about resources, including the primary node, components of the resource group, and failover policy is specified when you configure your FailSafe system with the GUI or with the `cmgr` command. Information on configuring the system is provided in Chapter 6, "Configuration" on page 141. Monitoring scripts detect the failure of a resource.

The FailSafe software provides a framework for making applications highly available services. By writing scripts and configuring the system in accordance with those scripts, you can turn client/server applications into highly available applications. For information, see the *FailSafe Programmer's Guide for SGI Infinite Storage*.

## Failover and Recovery Processes

A *failure* is when the node has crashed, hung, or been shut down, or when a highly available service is no longer operating. The node with the failure is called the *failed node*. A different node performs a failover of the highly available services that were being provided on the failed node. *Failover* allows all of the highly available services, including those provided by the failed node, to remain available within the cluster.

Depending on which node detects the failure, the sequence of actions following the failure is different.

If the failure is detected by the FailSafe software running on the same node, the failed node performs the following operations:

- Stops the highly available resource group running on the failed node
- Moves the highly available resource group to a different node, according to the defined failover policy for the resource group
- Asks the new node to start providing all resource group services previously provided by the failed node



When it receives the message, the node that is taking over the resource group performs the following operations:

- Transfers ownership of the resource group from the failed node to itself
- Starts offering the resource group services that were running on the failed node

If the failure is detected by FailSafe software running on a different node, the node detecting the failure performs these operations:

- Power-cycles the failed node (to prevent corruption of data) by using the serial hardware rest connection between the nodes
- Transfers ownership of the resource group from the failed node to the other nodes in the cluster, based on the resource group failover policy
- Starts offering the resource group services that were running on the failed node

When a failed node comes back up, whether or not the node automatically starts to provide highly available services again depends on the failover policy that you define.

For more information, see "Define a Failover Policy with the GUI" on page 223.

Normally, a node that experiences a failure automatically reboots and resumes providing highly available services. This scenario works well for transient errors (as well as for planned outages for equipment and software upgrades).

For further information on FailSafe execution during startup and failover, see *FailSafe Architecture for SGI InfiniteStorage*.

## Overview of Configuring and Testing a New Cluster

After the FailSafe cluster hardware has been installed, use the following general procedure to configure and test the FailSafe system:

1. Become familiar with FailSafe terms by reviewing this chapter.
2. Plan the configuration of highly available applications and services on the cluster using Chapter 2, "Configuration Planning" on page 31.
3. Perform various administrative tasks, including the installation of prerequisite software, that are required by FailSafe, as described in Chapter 4, "FailSafe Installation and System Preparation" on page 87.

4. Define the configuration as explained in Chapter 6, "Configuration" on page 141.
5. Test the system. See "Testing the Configuration" on page 76, and Chapter 9, "Testing the Configuration" on page 337.

## Release Support Policy

As of IRIS FailSafe 2.1.6, FailSafe supports a cluster containing nodes running  $n-2$  releases. For example, you can have nodes running FailSafe 2.1.6 ( $n$ ), 2.1.5, and 2.1.4 in the same cluster. This policy lets you to keep your cluster running and applications available during the upgrade process.

Each IRIS FailSafe release is paired with a given even-numbered IRIX release, and will also support the following odd-numbered release. For example, IRIS FailSafe 2.1.6 supports IRIX 6.5.22 and IRIX 6.5.23.

## Configuration Planning

This chapter explains how to plan the configuration of highly available (HA) services on your FailSafe cluster. The major sections of this chapter are as follows:

- "Example of the Planning Process"
- "Disk Configuration" on page 32
- "XFS Filesystem Configuration" on page 38
- "CXFS Filesystem Configuration" on page 46
- "HA IP Address Configuration" on page 53

### Example of the Planning Process

As an example of the configuration planning process, suppose that you have a two-node FailSafe cluster that is a departmental server. You want to make four XFS filesystems available for NFS mounting and have two Netscape FastTrack servers, each serving a different set of documents. These applications will be HA services.

You decide to distribute the services across the nodes, so that each node will be the primary node for two filesystems and one Netscape server. The filesystems and the document roots for the Netscape servers (on XFS filesystems) are each on their own plexed XLV logical volume. The logical volumes are created from disks in a Fibre Channel storage system connected to both nodes.

There are four resource groups:

- NFSgroup1
- NFSgroup2
- Webgroup1
- Webgroup2

NFSgroup1 and NFSgroup2 are the NFS resource groups; Webgroup1 and Webgroup2 are the Web resource groups. NFSgroup1 and Webgroup1 will have one node as the primary node. NFSgroup2 and Webgroup2 will have the other node as the primary node.

Two networks are available on each node, `ef0` and `ef1`. The `ef1` network interfaces in each node are connected to each other to form a private network.

Figure 2-1 depicts this configuration.

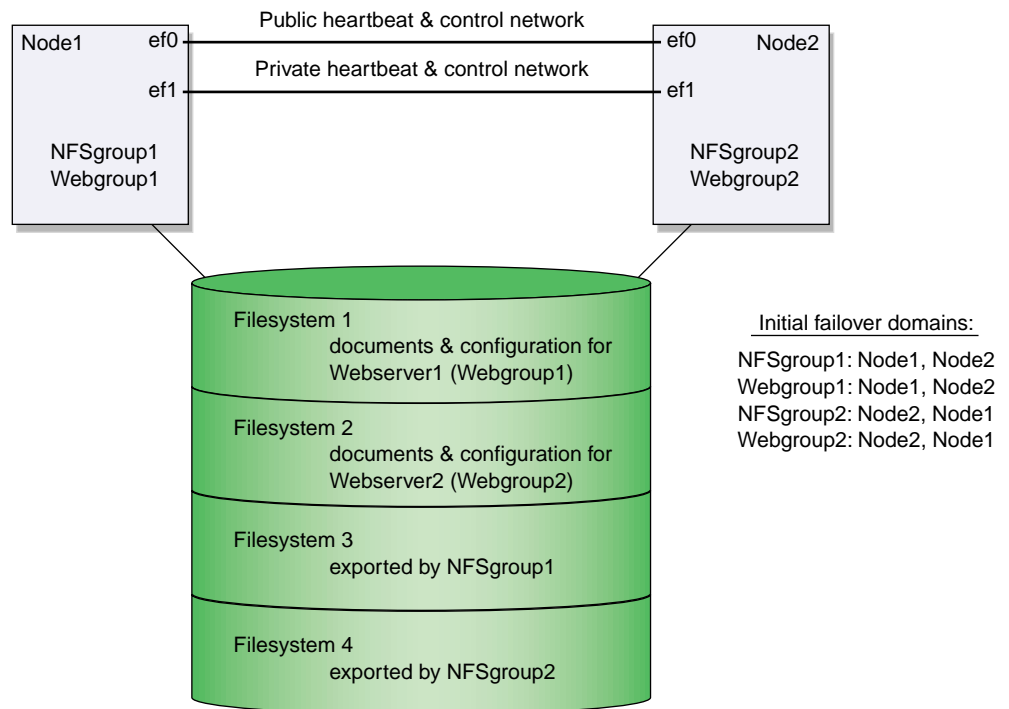

**Figure 2-1** Example Configuration with Four Resource Groups

## Disk Configuration

This section contains the following:

- "Planning Disk Configuration" on page 33
- "Configuration Parameters for Disks" on page 38

## Planning Disk Configuration

For each disk in a FailSafe cluster, you must choose whether to make it a shared disk, which enables it to be failed over, or a non-shared disk. Non-shared disks are not failed over.

The nodes in a FailSafe cluster must follow these requirements:

- The system disk must be a non-shared disk
- The FailSafe software must be on a non-shared disk
- All system directories (such as `/tmp`, `/var`, `/usr`, `/bin`, and `/dev`) should be in a non-shared disk

Only HA application data and configuration data can be placed on a shared disk. Choosing to make a disk shared or non-shared depends on the needs of the HA services that use the disk. Each HA service has requirements about the location of data associated with the service:

- Some data must be placed on non-shared disks
- Some data must not be placed on shared disks
- Some data can be on either shared or non-shared disks

The figures in the remainder of this section show the basic disk configurations on FailSafe clusters before and after failover. A cluster can contain a combination of the following basic disk configurations:

- A non-shared disk on each node
- Multiple shared disks containing Web server and NFS file server documents

---

**Note:** In each of the before and after failover diagrams, each disk shown can represent a set of disks.

---

Figure 2-2 shows two nodes in a cluster, each of which has a non-shared disk with two resource groups. When non-shared disks are used by HA applications, the data required by those applications must be duplicated on non-shared disks on both nodes. The clients should access the data in the shared disk using an HA IP address (alias). When a failover occurs, HA IP addresses fail over. (The hostname is bound to a different IP address that never moves.)

The data that was originally available on the failed node is still available from the replacement node by using the HA IP address to access it.

The configuration in Figure 2-2 contains two resource groups:

Resource Group	Resource Type	Resource
Group1	IP_address	192.26.50.1
Group2	IP_address	192.26.50.2

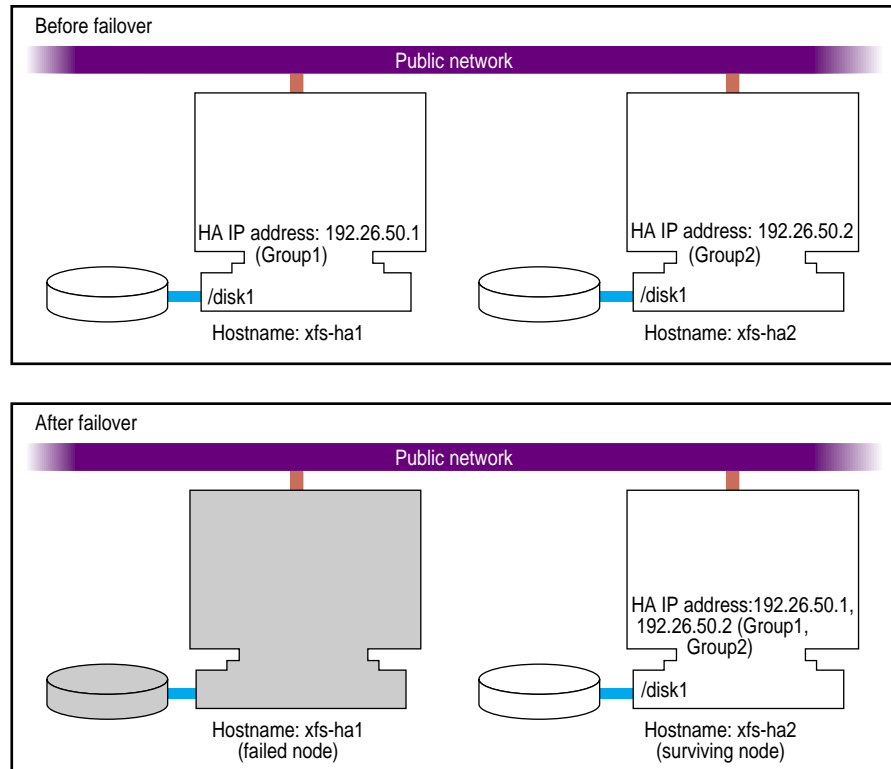
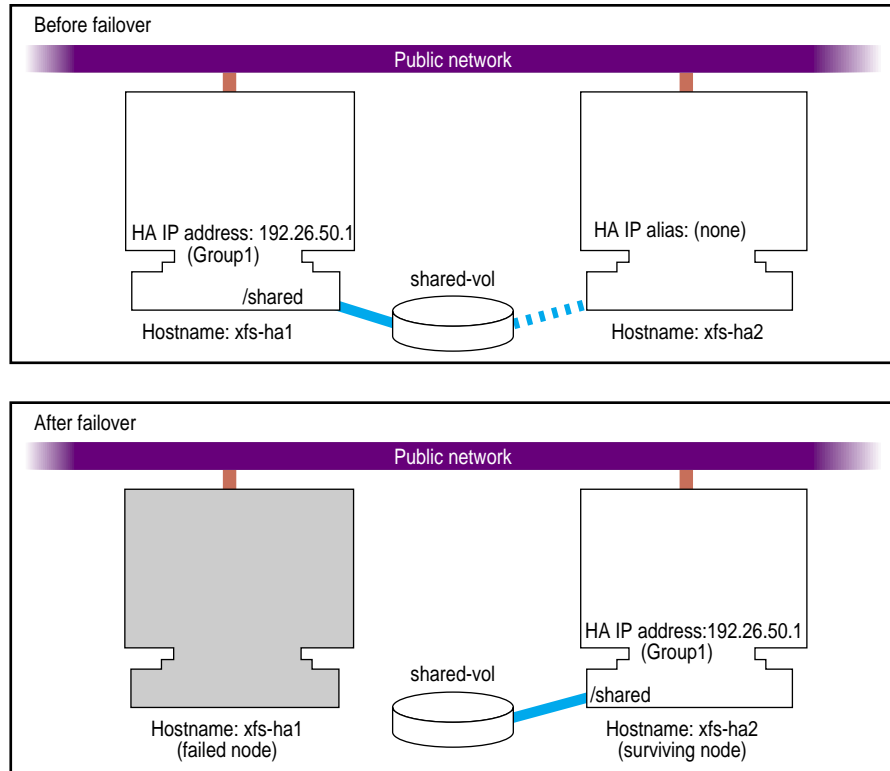

Figure 2-2 Non-Shared Disk Configuration and Failover

Figure 2-3 shows a two-node configuration with one resource group, Group1:

Resource Group	Resource Type	Resource	Failover Domain
Group1	IP_address	192.26.50.1	xfS-ha1, xfS-ha2
	filesystem	/shared	
	volume	shared_vol	

In this configuration, the resource group Group1 has a *primary node*, which is the node that accesses the disk prior to a failover. It is shown by a solid line connection. The backup node, which accesses the disk after a failover, is shown by a dotted line. Thus, the disk is shared between the nodes. In an *active/backup configuration*, all resource groups have the same primary node. The backup node does not run any HA resource groups until a failover occurs.



**Figure 2-3** Shared Disk Configuration for Active/Backup Use

Figure 2-4 shows two shared disks in a two-node cluster with two resource groups, Group1 and Group2:

Resource Group	Resource Type	Resource	Failover Domain
Group1	IP_address	192.26.50.1	xfs-ha1, xfs-ha2
	filesystem	/shared1	
	volume	shared1_vol	
Group2	IP_address	192.26.50.2	(xfs-ha2, xfs-ha1)



Resource Group	Resource Type	Resource	Failover Domain
	filesystem	/shared2	
	volume	shared2_vol	

In this configuration, each node serves as a primary node for one resource group. The solid line connections show the connection to the primary node prior to fail over. The dotted lines show the connections to the backup nodes. After a failover, the surviving node has all the resource groups.

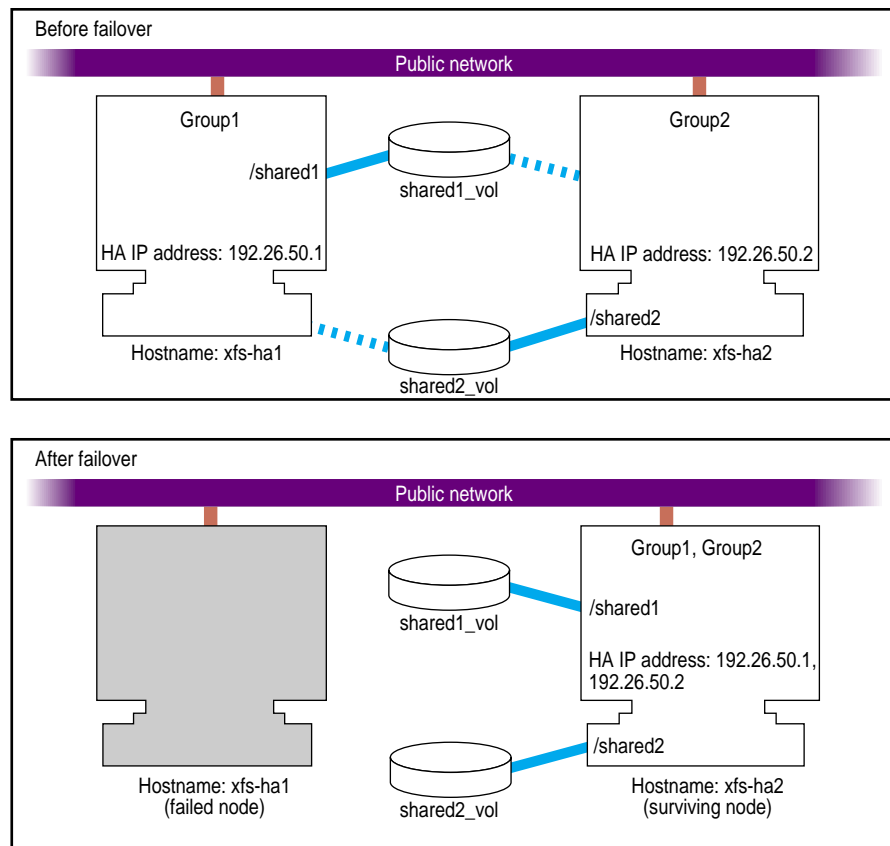

**Figure 2-4** Shared Disk Configuration for Dual-Active Use

Other sections in this chapter and similar sections in the *IRIS FailSafe 2.0 Oracle Administrator's Guide* and *IRIS FailSafe 2.0 INFORMIX Administrator's Guide* provide more specific information about choosing between shared and non-shared disks for various types of data associated with each HA service.

## Configuration Parameters for Disks

Raw disks cannot be failed over by FailSafe. Shared disks must be part of XLV or XVM volume in order for them to be failed over by FailSafe and must be configured as XLV or XVM resources. For more information, see "XLV Logical Volumes" on page 38, and "Local XVM Volumes" on page 40.

For information on using CXFS filesystems (which use XVM logical volumes) in a FailSafe configuration, see "Coexecution of CXFS and FailSafe" on page 47.

## XFS Filesystem Configuration

This section discusses XFS filesystems in XLV or local-mode XVM logical volumes:

- "XLV Logical Volumes" on page 38
- "Local XVM Volumes" on page 40
- "Local XVM Snapshots" on page 41
- "Planning XFS Filesystems" on page 42
- "Example XLV Filesystem Configuration" on page 45

## XLV Logical Volumes

---

**Note:** This section describes logical volume configuration using XLV logical volumes. See also "Coexecution of CXFS and FailSafe" on page 47, and "Local XVM Volumes" on page 40.

---

This section contains the following:

- "Example Logical Volume Configuration" on page 39
- "Resource Attributes for Logical Volumes" on page 39

See also "Planning XFS Filesystems" on page 42

### Example Logical Volume Configuration

As an example of logical volume configuration, say that you have the following logical volumes on disks that we will call Disk1 through Disk5:

- /dev/xlv/VolA (volume A) contains Disk1 and a portion of Disk2
- /dev/xlv/VolB (volume B) contains the remainder of Disk2 and Disk3
- /dev/xlv/VolC (volume C) contains Disk4 and Disk5

VolA and VolB must be part of the same resource group because they share a disk. VolC could be part of any resource group. Figure 2-5 describes this.

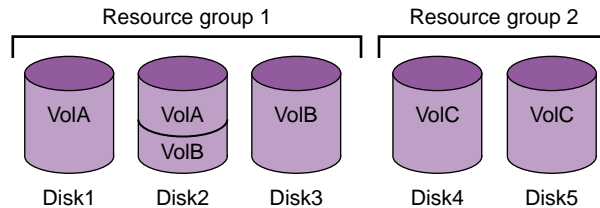

**Figure 2-5** Example Logical Volume Configuration

### Resource Attributes for Logical Volumes

Table 2-1 lists the resource attributes for XLV logical volumes.

**Table 2-1** XLV Logical Volume Resource Attributes

Resource Attribute	Default	Description
devname-owner	root	Owner of the XLV device name
devname-group	sys	Group of the XLV device name
devname-mode	0600	File permission mode of the XLV device name

See the section "Create XLV Logical Volumes and XFS Filesystems" on page 98, for information about creating XLV logical volumes.

## Local XVM Volumes

FailSafe also supports local XVM; you cannot use local XVM with CXFS.

### xvm Resource Type for FailSafe

FailSafe provides the *xvm* resource type, which can be used to fail over applications that use local XVM volumes without CXFS. (Do not use the *xvm* resource type with the *CXFS* resource type.)

For each local *xvm* resource, the name of the resource is the name of the XVM volume without the preceding *vol/* characters. The resource name must be unique for all XVM domains in the FailSafe cluster.

### Resource Attributes for Local XVM Volumes

Table 2-2 provides the *xvm* resource attributes. There are no resource type dependencies for the *xvm* resource type.

**Table 2-2** Local XVM Volume Resource Attributes

Resource Attribute	Default	Description
<code>devname_owner</code>	<code>root</code>	Owner of the XVM device name. Databases that use XVM volumes often require that the owner be changed to the database user. This attribute is optional.
<code>devname_group</code>	<code>sys</code>	Group of the XVM device name. Databases that use XVM volumes request the device group to be the database user group. This attribute is optional.
<code>devname_mode</code>	<code>0600</code>	File permission mode of the XVM device file. This attribute is optional.

Resource Attribute	Default	Description
fs_xvm_owner	fake_owner	FailSafe XVM temporary owner. The value can be any string <b>other than</b> the name of cluster or the hostname of any of the nodes in the FailSafe cluster.
physvol_names	(no default)	The list of physical volumes that make up the XVM volume, separated by commas (spaces are not accepted). You can obtain the list of physical volumes by using the <code>xvm show</code> command.

### Example Local XVM Volume Configuration

Following is an example local XVM volume configuration:

```
cmgr> show resource lun1 of resource_type XVM in cluster lab-cluster

fs_xvm_owner: fake_owner
devname_group: sys
physvol_names: lun1,lun2,lun3
devname_mode: 600
devname_owner: root
```

### Local XVM Snapshots

If local XVM volumes have a snapshot on repository volumes, both the repository volume and the base volume should be configured as XVM resources. The repository volume and the base volume should be included in the same resource group. The snapshots will continue to work on a backup node after a resource group failover.

For example, suppose that `lun0_vol` is a local XVM volume and `lun0_vol` snapshots are in repository volume `lun2_vol`:

```
xvm:local> show vol/lun0_vol
vol/lun0_vol          0 online,open,basevol
xvm:local> show vol/lun2_vol
vol/lun2_vol          0 online,open,repository
```

You should configure `lun0_vol` and `lun2_vol` as FailSafe resources with resource type XVM and add them to the same resource group.

If the repository volume and the base volume have different sets of physical volumes, the following messages will be logged in the `/var/adm/SYSLOG` file and to the console during failover:

```
Sep 23 14:49:01 4A:machine1 unix: WARNING: xvm_get_rephdl() can't locate ve for repository  
uuid
```

You can ignore these messages because the repository volume and base volume are in the same resource group.

For information about creating repository volumes and XVM snapshots, see the *XVM Volume Manager Administrator's Guide*

### Planning XFS Filesystems

FailSafe supports the failover of XFS filesystems on shared disks. FailSafe supports XFS filesystems using XLV or local XVM (you cannot use local XVM with CXFS XVM).

Shared disks must be either JBOD (Fibre Channel or SCSI) or RAID storage systems. Fibre Channel and SCSI JBOD storage systems must use mirroring.

The following are special issues that you must be aware of when you are working with XFS filesystems on shared disks in a cluster:

- All XFS filesystems to be failed over must be created on XLV logical volumes or local XVM volumes on shared disks.
- For availability, XFS filesystems to be failed over in a cluster must be created on either mirrored disks (using the XLV plexing software) or on the Fibre Channel RAID storage system.
- Create the mount points for the filesystems on all nodes in the failover domain.
- When you set up the various XFS filesystems on each node, ensure that each filesystem uses a different mount point.
- Do not simultaneously mount filesystems on shared disks on more than one node. Doing so causes data corruption. Normally, FailSafe performs all mounts of filesystems on shared disks. If you manually mount a filesystem on a shared disk, verify that it is not being used by another node.
- Do not place filesystems on shared disks in the `/etc/fstab` file. FailSafe mounts these filesystems only after verifying that another node does not have these filesystems mounted.

The name of a resource of the `filesystem` resource type is the mount point of the filesystem.

When clients are actively writing to a FailSafe NFS filesystem during failover of filesystems, data corruption can occur unless filesystems are exported with the mode `wsync`. This mode requires that local mounts of the XFS filesystems use the `wsync` mount mode as well. Using `wsync` affects performance considerably in general; however, FailSafe itself has no impact (if you normally run NFS with `wsync` with good results, you can continue to do so with FailSafe.)

You can work with logical volumes on shared disks as you would work with other disks. However, you must follow these rules:

- All data that is used by HA applications on shared disks must be stored in logical volumes.
- If you create more than one volume on a single physical disk, all of those volumes must be owned by the same node. For example, if a disk has two partitions that are part of two volumes, both volumes must be part of the same resource group.
- Each disk in a Fibre Channel vault, SCSI vault, or RAID logical unit number (LUN) must be part of one resource group. Therefore, you must divide the Fibre Channel or SCSI Vault disks and RAID LUNs into one set for each resource group. If you create multiple volumes on a Fibre Channel or SCSI Vault disk or RAID LUN, all of those volumes must be part of one resource group.
- Do not simultaneously access a shared XLV volume from more than one node. Doing so causes data corruption.

The FailSafe software relies on the XLV naming scheme to operate correctly. A fully qualified XLV volume name uses one of the following formats:

*pathname/volname*  
*pathname/nodename.volname*

where:

- *pathname* is `/dev/xlv`
- *nodename* by default is the same as the hostname of the node on which the volume was created
- *volname* is a name specified when the volume was created; this component is commonly used when a volume is to be operated on by any of the XLV tools

For example, if volume `vol1` is created on node `ha1` using disk partitions located on a shared disk, the raw character device name for the assembled volume is `/dev/rxlv/vol1`. On the peer `ha2`, however, the same raw character volume appears as `/dev/rxlv/ha1.vol1`, where `ha1` is the *nodename* component and `vol1` is the *volname* component. As can be seen from this example, when the *nodename* component is the same as the local hostname, it does not appear as part of the device node name.

One *nodename* is stored in each disk or LUN volume header. This is why all volumes with volume elements on any single disk must have the same *nodename* component.



---

**Caution:** If this rule is not followed, FailSafe does not operate correctly.

---

FailSafe modifies the *nodename* component of the volume header as volumes are transferred between nodes during failover and recovery operations. This is important because `xlv_assemble` assembles only those volumes whose *nodename* matches the local hostname. Some of the other XLV utilities allow you to see (and modify) all volumes, regardless of which node owns them.

FailSafe provides the *XVM* resource type, which can be used to fail over applications that use local *XVM* volumes without CXFS. (Do not use the *XVM* resource type with the CXFS resource type.) FailSafe also provides the *volume* resource type, which can be used to fail over applications that use XLV. You can have *XVM* and XLV volumes in the same cluster.

For each local *XVM* resource, the name of the resource is the name of the *XVM* volume without the preceding `vol/` characters. The resource name must be unique for all *XVM* domains in the FailSafe cluster.

For each *volume* resource, the name of the resource is the XLV volume name.

If you use XLV logical volumes as raw volumes (that is, with no filesystem) for storing database data, the database system may require that the device names in `/dev/xlv` have specific owners, groups, and modes. See the documentation provided by the database vendor to determine if the XLV logical volume device name must have owner, group, and mode values that are different from the default values (the defaults are `root`, `sys`, and `0600`, respectively).



## Example XLV Filesystem Configuration

This section contains an example XLV filesystem configuration. For information on coexecution of FailSafe and CXFS filesystems, see "Coexecution of CXFS and FailSafe" on page 47.

Continuing with the scenario from in "Example Logical Volume Configuration" on page 39, suppose you have the following XFS filesystems:

- xfsA on VolA is mounted at /sharedA with modes rw and noauto
- xfsB on VolB is mounted at /sharedB with modes rw, noauto, and wsync
- xfsC on VolC is mounted at /sharedC with modes rw and noauto

Table 2-3 lists a label and configuration parameters for each filesystem.

**Table 2-3** Filesystem Configuration Parameters

Attribute	/sharedA	/sharedB	/sharedC	Comments
monitor-level	2	2	2	There are two levels of monitoring: 1 – checks /etc/mtab file 2 – checks if the filesystem is mounted using the stat command
volume-name	VolA	VolB	VolC	The label of the logical volume on which the filesystem was created
mode	rw,noauto	rw, noauto, wsync	rw, noauto	The modes of the filesystem (identical to the modes specified in /etc/fstab)

Figure 2-6 shows the following:

- Resource group 1 has two XFS filesystems (xfsA and xfsB) and two XLV volumes (VolA and VolB)
- Resource group 2 has one XFS filesystem (xfsC) and one XLV volume (VolC)

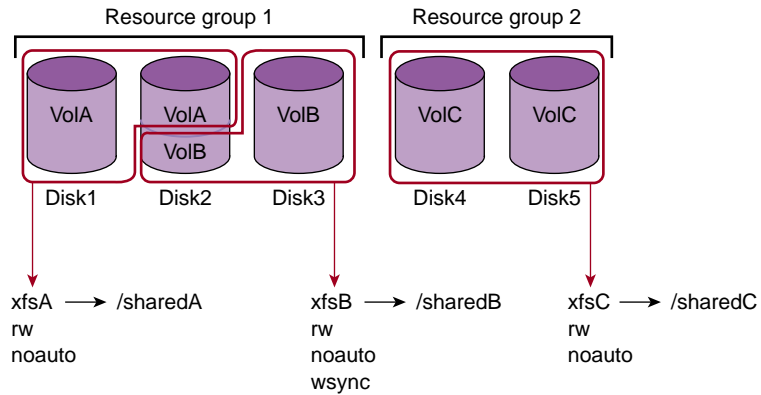

**Figure 2-6** Filesystems and Logical Volumes

See "Create XLV Logical Volumes and XFS Filesystems" on page 98, for information about creating XFS filesystems.

## CXFS Filesystem Configuration

This section discusses planning CXFS filesystems and coexecution of CXFS and FailSafe.

### Planning CXFS Filesystems

A cluster that is running both CXFS and FailSafe is known as a *coexecution cluster*.

CXFS allows a cluster of computers to coherently share large amounts of data while maintaining high performance. You can use FailSafe to provide HA services (such as for NFS or Web) running on a CXFS filesystem. The CXFS plug-in for FailSafe moves the applications that must run on the metadata server, such as DMF, when CXFS moves the metadata server. This combination of CXFS and FailSafe provides high-performance shared data access for HA applications.

FailSafe assumes that CXFS filesystems are highly available because they do not require a FailSafe failover in order to be made available on another node in the cluster; CXFS contains its own recovery and relocation functions. Therefore, FailSafe does not directly start or stop CXFS filesystems nor does it stop, start, or monitor

clustered XVM volumes. Clustered XVM volumes should not be added to the FailSafe resource groups.

---

**Note:** CXFS provides a system tunable parameter (`cxfs_relocation_ok`) to allow users to enable (1) or disable (0) CXFS metadata server relocation. CXFS filesystem relocation is disabled by default.

The system tunable parameter is different from the `relocate-mds` attribute of a CXFS resource. If `relocate-mds` is set to `true`, FailSafe will use the CXFS relocation mechanism to relocate the metadata server in the event of a resource group failover. The CXFS relocation mechanism does not unmount the CXFS filesystem and allows the application using the CXFS filesystem to run without interruption. The CXFS plug-in sets the `cxfs_relocation_ok` systune to 1 (enable).

---

The metadata server list must exactly match the failover domain list (the names and the order of names).

## Coexecution of CXFS and FailSafe

In a coexecution cluster, there is a single cluster database that is used by both CXFS and FailSafe. The cluster database contains configuration information about nodes, clusters, logging information, and configuration parameters. When running CXFS, it also contains information about CXFS filesystems and CXFS metadata servers. When running FailSafe, it also contains information about resources, resource groups, and failover policies. Figure 2-7 depicts the contents of a coexecution cluster database.

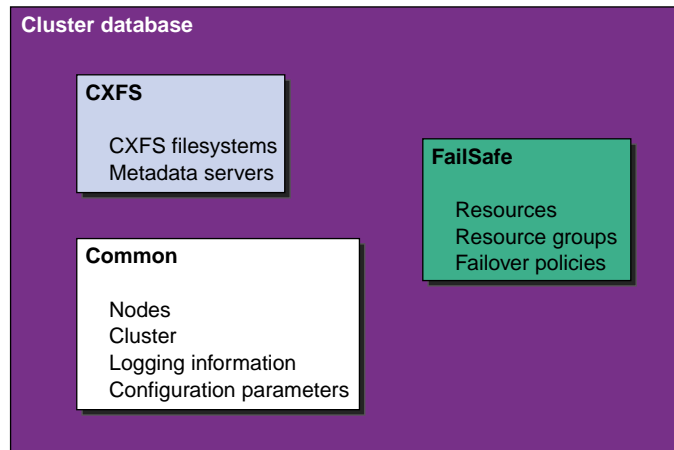

**Figure 2-7** Contents of a Coexecution Cluster Database

A subset of IRIX nodes in a coexecution cluster can be configured to be used as FailSafe nodes; a coexecution cluster can have as many as eight nodes that run FailSafe. All FailSafe nodes in a coexecution cluster must be CXFS administration nodes (they cannot be CXFS client-only nodes).

This section contains the following:

- "Size of the Coexecution Cluster" on page 49
- "Cluster Type" on page 49
- "Node Types for CXFS Metadata Servers" on page 50
- "CXFS Metadata Servers and Failover Domain" on page 50
- "CXFS Resource Type for FailSafe" on page 50
- "Separate CXFS and FailSafe GUIs" on page 52
- "Conversion Between CXFS and FailSafe" on page 52
- "Network Interfaces" on page 53

### Size of the Coexecution Cluster

A coexecution cluster is supported with as many as 64 nodes. All of these nodes must run CXFS and up to 8 can also run FailSafe. As many as 16 of the nodes can be CXFS administration nodes and all other nodes can be CXFS client-only nodes. FailSafe must be run on an IRIX CXFS administration node; FailSafe cannot run on a client-only node.

You should configure a production cluster with an odd number of CXFS metadata server-capable administration nodes. (A cluster with serial hardware reset cables and only two server-capable nodes is supported, but there are inherent issues with this configuration; see the *CXFS Administration Guide for SGI InfiniteStorage*.)

Even when you are running CXFS and FailSafe, there is still only one pool, one cluster, and one cluster configuration.

### Cluster Type

The cluster can be one of three types:

- `FailSafe`. In this case, all nodes will also be of type `FailSafe`.
- `CXFS`. In this case, all nodes will be of type `CXFS`.
- `CXFS` and `FailSafe` (coexecution). In this case, the set of nodes will be a mix of type `CXFS` and type `CXFS` and `FailSafe`, using `FailSafe` for application-level high availability and `CXFS`.

---

**Note:** Although it is possible to configure a coexecution cluster with type `FailSafe` only nodes, SGI does not support this configuration.

---

### Node Types for CXFS Metadata Servers

All potential metadata server nodes must be of one of the following types:

- CXFS
- CXFS and FailSafe

### CXFS Metadata Servers and Failover Domain

The metadata server list must exactly match the failover domain list (the names and the order of names).

### CXFS Resource Type for FailSafe

FailSafe provides the CXFS resource type, which can be used to fail over applications that use CXFS filesystems.

FailSafe assumes that CXFS filesystems are highly available and will recover from CXFS failures (including loss of CXFS membership). FailSafe will wait for CXFS to recover CXFS filesystems before the resource group containing in the CXFS resource is started on another FailSafe node in the cluster.

Resources of type CXFS must be added to the resource group that contain the resources that depend on a CXFS filesystem. The name of the resource is the CXFS filesystem mount point.

The CXFS resource type has the following characteristics:

- It does not start all resources that depend on the CXFS filesystem until the CXFS filesystem is mounted on the local node.
- The `start` and `stop` action scripts for the CXFS resource type do not mount and unmount CXFS filesystems, respectively. (The `start` script waits for the CXFS filesystem to become available; the `stop` script does nothing but its existence is required by FailSafe.) Users should use the CXFS graphical user interface (GUI) or `cmgr` command to mount and unmount CXFS filesystems.
- It monitors CXFS filesystem for failures.
- Optionally, for applications that must run on a CXFS metadata server, the CXFS resource type relocates the CXFS metadata server when there is an application failover (assuming that the `relocate-mds` flag is set to `true`). In this case, the

application failover domain (AFD) for the resource group should consist of the CXFS metadata server and the filesystem's potential metadata server nodes.

The CXFS filesystems that an NFS server exports should be mounted on all nodes in the failover domain using the CXFS GUI or the `cmgr` command.

For example, following are the commands used to create resources named `NFS`, `CXFS` and `statd_unlimited` based on a CXFS filesystem mounted on `/FC/lun0_s6`. (This example assumes that you have defined a cluster named `test-cluster` and that you have already created a failover policy named `cxfs-fp` and a resource group named `cxfs-group` based on this policy.)

```
cmgr> define resource /FC/lun0_s6 of resource_type CXFS in cluster test-cluster
```

```
Enter commands, when finished enter either "done" or "cancel"
```

```
Type specific attributes to create with set command:
```

```
Type Specific Attributes - 1: relocate-mds
```

```
No resource type dependencies to add
```

```
resource /FC/lun0_s6 ? set relocate-mds to false
```

```
resource /FC/lun0_s6 ? done
```

```
=====
```

```
cmgr> define resource /FC/lun0_s6 of resource_type NFS in cluster test-cluster
```

```
Enter commands, when finished enter either "done" or "cancel"
```

```
Type specific attributes to create with set command:
```

```
Type Specific Attributes - 1: export-info
```

```
Type Specific Attributes - 2: filesystem
```

```
No resource type dependencies to add
```

```
resource /FC/lun0_s6 ? set export-info to rw
```

```
resource /FC/lun0_s6 ? set filesystem to /FC/lun0_s6
```

```
resource /FC/lun0_s6 ? done
```

## 2: Configuration Planning

---

```
=====
cmgr> define resource /FC/lun0_s6/statmon of resource_type statd_unlimited in cluster test-cluster
Enter commands, when finished enter either "done" or "cancel"

Type specific attributes to create with set command:

Type Specific Attributes - 1: ExportPoint

Resource type dependencies to add:

Resource Dependency Type - 1: NFS

resource /FC/lun0_s6/statmon ? set ExportPoint to /FC/lun0_s6
resource /FC/lun0_s6/statmon ? add dependency /FC/lun0_s6 of type NFS
resource /FC/lun0_s6/statmon ? done

=====
cmgr> define resource_group cxfs-group in cluster test-cluster
Enter commands, when finished enter either "done" or "cancel"

resource_group cxfs-group ? set failover_policy to cxfs-fp
resource_group cxfs-group ? add resource /FC/lun0_s6 of resource_type NFS
resource_group cxfs-group ? add resource /FC/lun0_s6 of resource_type CXFS
resource_group cxfs-group ? add resource /FC/lun0_s6/statmon of resource_type statd_unlimited
resource_group cxfs-group ? done
```

### Separate CXFS and FailSafe GUIs

There is one `cmgr` command but separate GUIs for CXFS (`cxfsmgr`) and for FailSafe (`fsmgr`). You must manage CXFS configuration with the CXFS GUI and FailSafe configuration with the FailSafe GUI; you can manage both with `cmgr`.

### Conversion Between CXFS and FailSafe

Using the CXFS GUI or `cmgr`, you can convert an existing FailSafe cluster and nodes to type CXFS or to type CXFS and FailSafe. You can perform a parallel



action using the FailSafe GUI. A converted node can be used by FailSafe to provide application-level high-availability and by CXFS to provide clustered filesystems.

However:

- You cannot change the type of a node if the respective high availability (HA) or CXFS services are active. You must first stop the services for the node.
- The cluster must support all of the functionalities (FailSafe and/or CXFS) that are turned on for its nodes; that is, if your cluster is of type `CXFS`, then you **cannot** modify a node that is already part of the cluster so that it is of type `FailSafe`. However, the nodes do not have to support all the functionalities of the cluster; that is, you can have a `CXFS` node in a `CXFS` and `FailSafe` cluster.

## Network Interfaces

For FailSafe, you must have at least two network interfaces. However, CXFS uses only one interface for **both** heartbeat and control messages.

When using FailSafe and CXFS on the same node, the network must be set to allow both heartbeat and control messages.

---

**Note:** It is recommended that same heartbeat and control networks must be used for CXFS and FailSafe in a coexecution cluster.

---

## HA IP Address Configuration

This section contains the following:

- "Planning Network Interface and HA IP Address Configuration"
- "Determining if Re-MACing is Required" on page 55
- "Example HA IP Address Configuration" on page 56
- "Local Failover of HA IP Addresses" on page 56
- "Using FailSafe with SGI Gigabit Ethernet Interfaces" on page 57

## Planning Network Interface and HA IP Address Configuration

Use the following guidelines when planning interface configuration for the private control network between nodes:

- Each interface has one IP address.
- The HA IP addresses used on each node for the interfaces to the private network are on a different subnet from the IP addresses used for public networks.
- An IP name can be specified for each HA IP address in `/etc/hosts`.
- A naming convention that identifies these HA IP addresses with the private network can be helpful. For example, precede the hostname with `priv-` (for *private*), as in `priv-xfsh1` and `priv-xfsh2`.

Use the following guidelines when planning the interface configuration for one or more public networks:

- If re-MACing is required, each interface to be failed over requires a dedicated backup interface on the other node (an interface that does not have an HA IP address). Thus, for each HA IP address on an interface that requires re-MACing, there should be one interface in each node in the failover domain dedicated for the interface.
- Each interface has a primary IP address also known as the fixed address. The primary IP address does not fail over.
- The hostname of a node cannot be an HA IP address.
- All HA IP addresses used by clients to access HA services must be part of the resource group to which the HA service belongs.
- If re-MACing is required, all of the HA IP addresses must have the same backup interface.
- Making good choices for HA IP addresses is important; these are the “hostnames” that will be used by users of the HA services, not the true hostnames of the nodes.
- Make a plan for publicizing the HA IP addresses to the user community, because users of HA services must use HA IP addresses instead of the output of the `hostname` command.
- HA IP addresses should not be configured in the `/etc/config/netif.options` file. HA IP addresses also should not be defined in the `/etc/config/ipaliases.options` file.

## Determining if Re-MACing is Required

Use the following procedure to determine whether re-MACing is required. It requires the use of three nodes: `node1`, `node2`, and `node3`. `node1` and `node2` can be nodes of a FailSafe cluster, but they need not be. They must be on the same subnet. `node3` is a third node. If you must verify that a router accepts gratuitous ARP packets (which means that re-MACing is not required), `node3` must be on the other side of the router from `node1` and `node2`. For more information about re-MACing, see "Network Interfaces and IP Addresses" on page 24.

1. Configure an HA IP address on one of the interfaces of `node1`. For example:

```
# /usr/etc/ifconfig interface inet ip_address netmask netmask up
```

*interface* is the interface to be used to access the node. *ip\_address* is an IP address for `node1`; this IP address is used throughout this procedure. *netmask* is the netmask of the IP address.

2. From `node3`, contact the HA IP address used in step 1 using the `ping` command:

```
# ping -c 2 ip_address
```

For example, if the value for *ip\_address* is 190.0.2.1:

```
# ping -c 2 190.0.2.1
PING 190.0.2.1 (190.0.2.1): 56 data bytes
64 bytes from 190.0.2.1: icmp_seq=0 ttl=255 time=29 ms
64 bytes from 190.0.2.1: icmp_seq=1 ttl=255 time=1 ms

----190.0.2.1 PING Statistics----
2 packets transmitted, 2 packets received, 0% packet loss
round-trip min/avg/max = 1/1/1 ms
```

3. Enter the following command on `node1` to shut down the interface you configured in step 1:

```
# /usr/etc/ifconfig interface down
```

4. On `node2`, enter the following command to move the HA IP address to `node2`:

```
# /usr/etc/ifconfig interface inet ip_address netmask netmask up
```

5. On `node3`, contact the HA IP address:

```
# ping -c 2 ip_address
```

If the `ping` command fails, gratuitous ARP packets are not being accepted and re-MACing is needed to fail over the HA IP address.

## Example HA IP Address Configuration

Table 2-4 shows the FailSafe configuration parameters you could specify for these example HA IP addresses.

**Table 2-4** HA IP Address Configuration Parameters

Resource Attribute	Resource Name: 192.26.50.1	Resource Name: 192.26.50.2
Network mask	0xffffffff00	0xffffffff00
Broadcast address	192.26.50.255	192.26.50.255
Interface	ef0	ef0

## Local Failover of HA IP Addresses

You can configure a FailSafe system to fail over an HA IP address to a second interface within the same host. To do this, you specify the multiple interfaces for the resources of `IP_address` resource type. For information on specifying HA IP address resources, see "IP\_address Attributes" on page 210.

IRIX allows only one interface to be configured up in a subnet. The backup interface should be configured down after it is configured up during the machine boot-up process. This requires that you add an `init.d` `local` script (linked in `rc2.d`) to set down all the backup interfaces right after the network start-up.

However, this procedure does not update the routing table after failing over one IP alias from one interface to the other. "Example: Local Failover of HA IP Address" on page 279 presents a modified procedure to ensure that the routing table is updated correctly after the local IP failover.

## Using FailSafe with SGI Gigabit Ethernet Interfaces

In order to use SGI gigabit Ethernet interfaces, you must set the `tg2` network interface so that a linkdown situation is identified. Enter the following for each interface that is configured to be used by a FailSafe HA IP address:

```
# tgconfig -a tg2 ignore_linkdown=OFF
```



## Best Practices

This chapter provides an overview of the best practices for system administration in a FailSafe cluster. It discusses the following:

- "Planning and Installing a FailSafe Cluster"
- "Knowing the Tools" on page 65
- "Configuration" on page 68
- "Administration and Operation" on page 77
- "Avoiding Problems" on page 84

### Planning and Installing a FailSafe Cluster

This section discusses the following:

- "How Do You Want to Use FailSafe?"
- "Planning Network Interface and HA IP Address Configuration" on page 54
- "Hardware Requirements" on page 61
- "Software Installation" on page 63
- "Customer Education" on page 65

### How Do You Want to Use FailSafe?

You must first decide how you want to use the FailSafe cluster, what applications you want to run, and which of these should be made highly available (HA). This includes deciding how software and data will be distributed. You can then configure the disks and interfaces to meet the needs of the HA services that you want the cluster to provide.

Questions you must answer during the planning process are as follows:

- How do you plan to use the nodes? Your answers might include uses such as offering home directories for users, running particular applications, supporting an Oracle database, providing Netscape Web service, and providing file service.
- Which of these uses will be provided as an HA service? SGI has developed FailSafe software options for some HA applications. To offer other applications as HA services, you must develop a set of application monitoring shell scripts as described in the *FailSafe Programmer's Guide for SGI Infinite Storage*. If you need assistance, contact SGI Professional Services, which offers custom FailSafe agent development and integration services.
- Which node will be the primary node for each HA service? The primary node is the node that provides the service (exports the filesystem, is a Netscape server, provides the database, and so on).
- For each HA service, how will the software and data be distributed on shared and non-shared disks? Each application has requirements and choices for placing its software on disks that are failed over (shared) or not failed over (non-shared).
- Are the shared disks going to be part of a RAID storage system or are they going to be disks in SCSI or Fibre Channel disk storage that have plexed logical volumes on them? Shared disks must be part of a RAID storage system or in a SCSI or Fibre Channel disk storage with plexed logical volumes on them.
- How will shared disks be configured?
  - As raw XLV logical volumes?
  - As XLV logical volumes with XFS filesystems on them?
  - As local XVM logical volumes with XFS filesystems on them?
  - As CXFS filesystems, which use XVM logical volumes? For information on using FailSafe and CXFS, see "Coexecution of CXFS and FailSafe" on page 47.

The choice of volumes or filesystems depends on the application that is going to use the disk space.

- Which IP addresses will be used by clients of HA services? Multiple interfaces may be required on each node because a node could be connected to more than one network or because there could be more than one interface to a single network.



- Which resources will be part of a resource group? All resources that are dependent on each other must be in the resource group.
- What will be the failover domain of the resource group? The failover domain determines the list of nodes in the cluster where the resource group can reside. For example, a volume resource that is part of a resource group can reside only in nodes from which the disks composing the volume can be accessed. For more information about failover domains, see "Failover Domain" on page 14.
- How many HA IP addresses on each network interface will be available to clients of the HA services? At least one HA IP address must be available for each interface on each node that is used by clients of HA services.
- Which HA IP addresses on nodes in the failover domain are going to be available to clients of the HA services?
- For each HA IP address that is available on a node in the failover domain to clients of HA services, which interface on the other nodes will be assigned that IP address after a failover? Every HA IP address used by an HA service must be mapped to at least one interface in each node that can take over the resource group service. The HA IP addresses are failed over from the interface in the primary node of the resource group to the interface in the replacement node.

## Hardware Requirements

FailSafe runs on a specific set of SGI servers and supported disk storage devices. A cluster can contain up to 8 nodes running FailSafe.

You should provide multiple sources of the following:

- Power sources.
- RAID disk devices and mirrored disks. FailSafe supports Fibre Channel RAID and mirrored disks in direct attach and SAN configurations.
- Paths to storage devices.
- Networks
- Fibre Channel switches or 100-MB hubs. If you have more than two nodes, SGI recommends that you use a switch rather than a hub to connect the nodes.

---

**Note:** No SCSI storage nor Fibre Channel JBOD is supported in a SAN configuration and therefore it cannot be used in a coexecution cluster with CXFS.

---

At least two Ethernet or FDDI interfaces on each node are required for the control network heartbeat connection, by which each node monitors the state of other nodes. The FailSafe software also uses this connection to pass control messages between nodes. These interfaces have distinct IP addresses.

FailSafe requires at least two networks of at least 100baseT. All nodes should be on the same local network segment.

---

**Note:** When mixing `ef` and `eg` interfaces, turn off the `HIGHBW` flag for the `eg` interfaces and be sure to run IRIX 6.5.18 or later plus any applicable patches in order to avoid various problems associated with `ef` interfaces and delayed acknowledgement on `eg` interfaces.

For `tg` interfaces that are part of the private network, it is recommended that `coal_mode` be set to `FIXED`, `coal_frames_rx` be set to 1 or 2, and `coal_usecs_rx` be set in the range 0-30.

---

For performance and security reasons, SGI recommends that the networks be private. Using a private network limits the traffic on the public network and therefore will help avoid unnecessary resets or disconnects. (If you are running CXFS on the same cluster, then the network must be private, as required by CXFS.) You may want to choose a numbering convention for private networks such as 192.26.50.*x* for primary network and 192.26.51.*x* for backup network, where *x* is the CXFS node ID in the cluster.

The serial hardware reset lines should use Cat5 wire with appropriate connectors and point-to-point connections between nodes. Be aware of the distance limitations for serial cables. If you use the hub method, you must have software loaded to control it and support it. You should have hardware flow control pins (RTS/CTS) connected in the serial cable.

For each disk in a FailSafe cluster, you must choose whether to make it a shared disk (allowing it to be failed over) or a non-shared disk. The system disk must be a non-shared disk. FailSafe software must be on a non-shared disk and all system directories (such as `/tmp`, `/var`, `/usr`, `/bin`, and `/dev`) should be on a non-shared disk.

## Software Installation

SGI recommends consulting SGI managed services before installing a FailSafe system. For more information, see:

[http://www.sgi.com/services/managed\\_services/](http://www.sgi.com/services/managed_services/)

FailSafe is released approximately every six months, with patch releases as necessary. A given FailSafe release supports two consecutive IRIX releases, as defined in the FailSafe release notes. For a complete compatibility matrix, contact SGI customer support.

You must install the cluster infrastructure and FailSafe software components. You may want to install software for ESP, Performance Co-Pilot, accounting, and `expect` (for the TMF plug-in). You may wish to use `sendmail` with an alias to be used when reporting problems to the system administrator.

SGI recommends that you make configuration changes when the same version of IRIX and the same version of FailSafe is running on all nodes in the cluster.

When a FailSafe system is running, you may need to perform various administration procedures without shutting down the entire cluster, such as the following:

- Add a node to an active cluster
- Delete a node from an active cluster
- Change control networks in a cluster
- Upgrade operating system software in an active cluster
- Upgrade FailSafe software in an active cluster
- Add new resource groups or resources in an active cluster
- Add a new hardware device in an active cluster

## FailSafe Plugins

Separate releases are available for the optional FailSafe application plug-ins, such as FailSafe for Samba. You should have your FailSafe cluster up and running before installing and configuring an optional plug-in.

The basic process is as follows:

1. Install, configure, and test the base FailSafe software as described in Chapter 4, "FailSafe Installation and System Preparation" on page 87.
2. Install any required application software and the plug-in software.
3. Perform any system file configuration required by the plug-in.
4. If needed, install the plug-in resource types.
5. Add the individual instances of the plug-in resources to the cluster database.
6. Create the resource group that will be failed over.
7. Test the failover.

## Upgrades

When you upgrade your OS software in an active cluster, you perform the upgrade on one node at a time. If the OS software upgrade does not require reboot or does not impact the FailSafe software, there is no need to use the OS upgrade procedure. If you do not know whether the upgrade will impact FailSafe software or if the OS upgrade requires a machine reboot, you should follow the upgrade procedure described in Chapter 4, "FailSafe Installation and System Preparation" on page 87.

In general, you should do the following:

1. Make sure you have a current copy of the cluster database, which you can obtain by using the `build_cmgr_script` command or the `cdbBackup` and `cdbRestore` commands.

---

**Note:** The `build_cmgr_script` does not recreate node-specific information for resources and resource types or local logging information because the cluster database does not replicate node-specific information. Therefore, if you reinitialize the cluster database, you will lose node specific information. The `build_cmgr_script` script does not contain local configuration information, so it cannot be used as a complete backup/restore tool.

---

2. Upgrade just one node in the cluster.
3. Verify that the FailSafe configuration works on the upgraded cluster.
4. Upgrade the remaining nodes.

## Customer Education

At least one administrator from the customer site should take the FailSafe customer training provided by SGI. For information about training, see the SGI customer education website:

<http://www.sgi.com/support/custeducation/>

## Knowing the Tools

This section provides an overview of the tools required to troubleshoot FailSafe:



---

**Caution:** Some of the commands listed are beyond the scope of this book and are provided here for quick reference only. See the other guides and man pages referenced for complete information before using these commands.

---

- "Physical Storage Tools"
- "Cluster Configuration Tools" on page 66
- "Cluster Control Tools" on page 66
- "Networking Tools" on page 66
- "Cluster/Node Status Tools" on page 66
- "Performance Monitoring Tools" on page 67

## Physical Storage Tools

To display the hardware inventory, use the `hinv` command. If you get unexpected output, ensure that there is no current I/O and then probe for devices, perform a SCSI bus reset, and configure the I/O devices by using the following commands

```
/usr/sbin/scsiha -pr bus_number  
/sbin/ioconfig -f /hw
```

## Cluster Configuration Tools

Understand the following cluster configuration tools, use one of the following:

- To configure FailSafe nodes and cluster, use the GUI (`fsmgr`) or the `cmgr` command line with prompting:

```
# cmgr -p
```

## Cluster Control Tools

Understand the following cluster control tools:

- To start and stop the cluster services daemons:

```
# /etc/init.d/cluster start
# /etc/init.d/cluster stop
```

These commands are useful if you know that filesystems are available but are not indicated as such by the cluster status, or if cluster quorum is lost.

- To start and stop HA services, use the GUI or the following `cmgr` commands:

```
cmgr> start ha_services on node hostname for cluster clustername
cmgr> stop ha_services on node hostname for cluster clustername
```

## Networking Tools

Understand the following networking tools:

- To send packets to network hosts, use the `ping` command.
- To show network status, use the `netstat` command.

## Cluster/Node Status Tools

Understand the following cluster/node status tools:

- To provide configuration information and the status of the cluster, nodes, resources, and resource groups, use the `haStatus` command.
- To show which cluster daemons are running, use the `ps` command:

```
# ps -ef | grep cluster
```

- To see cluster status, use the GUI (fsmgr) or the `cluster_status` command:

```
# /usr/cluster/cmgr-scripts/cluster_status
```

## Performance Monitoring Tools

Understand the following performance monitoring tools:

- To monitor system activity, use the `sar` command.
- To monitor filesystem buffer cache activity, use the `bufview` command.

---

**Note:** Do not use `bufview` interactively on a busy node; run it in batch mode (-b). For more information, see the `bufview(1)` man page.

---

- To monitor operating system activity data, use the `osview` command.
- To monitor system performance, use Performance Co-Pilot. See the *Performance Co-Pilot for IRIX Advanced User's and Administrator's Guide*, the *Performance Co-Pilot Programmer's Guide*, and the `pmie` and `pmieconf` man pages.

## Log Files

Understand the following log files:

- System log file (look for Membership delivered):
- `/var/adm/SYSLOG`
- `/var/cluster/ha/log/cad_log`
- `/var/cluster/ha/log/clconfd_hostname`
- `/var/cluster/ha/log/cli_hostname`
- `/var/cluster/ha/log/cmond_log`
- `/var/cluster/ha/log/crsd_hostname`
- `/var/cluster/ha/log/diags_hostname`
- `/var/cluster/ha/log/fs2d_log`
- System administration log: `/var/sysadm/salog`

## FailSafe Diagnostic Commands

Table 3-1 shows the tests you can perform with FailSafe diagnostic commands.

**Table 3-1** FailSafe Diagnostic Test Summary

Diagnostic Test	Description
Resource	Checks that: <ul style="list-style-type: none"><li>• Resource type parameters are set</li><li>• Parameters are syntactically correct</li><li>• Parameters exist</li></ul>
Resource group	Tests all resources defined in the resource group
Failover policy	Checks that: <ul style="list-style-type: none"><li>• Failover policy exists</li><li>• Failover domain contains a valid list of hosts</li></ul>
Network connectivity	Checks that: <ul style="list-style-type: none"><li>• The control interfaces are on the same network</li><li>• The nodes can communicate with each other</li></ul>
Serial connection	Checks that the nodes can reset each other (do not execute this command while FailSafe is running)

All transactions are logged to the diagnostics file `diags_Nodename` in the log directory.

You should test resource groups before starting FailSafe HA services or starting a resource group. These tests are designed to check for resource inconsistencies that could prevent the resource group from starting successfully.

## Configuration

This section discusses the following:

- "System File Configuration" on page 69
- "Cluster Database Configuration" on page 71
- "Appropriate Timeout Determination" on page 74



- "Tiebreaker Nodes" on page 74
- "Log Files" on page 75
- "Offline Detach Issues" on page 75
- "Testing the Configuration" on page 76

## System File Configuration

You must configure the following system files appropriately in order to use FailSafe:

- `/etc/hosts`
- `/etc/nsswitch.conf`
- `/etc/services`
- `/etc/config/cad.options`
- `/etc/config/fs2d.options`
- `/etc/config/cmond.options`

In addition, you must ensure that the following have the correct hostname information in `/etc/sys_id`.

The following hostname resolution rules and recommendations apply to FailSafe clusters:



**Caution:** It is critical that you understand these rules before attempting to configure a FailSafe cluster.

---

- The hostname must be configured on a network interface connected to the public network and should be resolved using `/etc/hosts`.
- Hostnames should not contain an underscore (`_`) or include any whitespace characters.
- The `/etc/hosts` file has the following format, where *hostname* can be the simple hostname or the fully qualified domain name:

*IP\_address hostname*

For example, suppose your `/etc/hosts` file contains the following:

```
# The public interface:
128.2.3.4  color-green.sgi.com color-green green

# The private interface:
192.0.1.1  color-green-private.sgi.com color-green-private green-private
```

The `/etc/sys_id` file could contain either the hostname `color-green` or the fully qualified domain name `color-green.sgi.com`.

In this case, you would enter the hostname `color-green` or the fully qualified domain name `color-green.sgi.com` for the **Server** field in the login screen and for the **Hostname** field in the **Define a new node** window.

- If you use the name service, you must configure your system so that local files are accessed before either the network information service (NIS) or the domain name service (DNS). That is, the `hosts` line in `/etc/nsswitch.conf` must list files first. For example:

```
hosts:      files nis dns
```

(The order of `nis` and `dns` is not significant to FailSafe; `files` must be first.)

The `/etc/config/netif.options` file must have one of the interfaces be equal to the value of `/etc/sys_id` (`$HOSTNAME`).

For more information see the `nsswitch.conf` and the `nsd` man pages.

- If you change the `/etc/nsswitch.conf` or `/etc/hosts` files, you must restart `nsd` by using the `nsadmin restart` command, which also flushes its cache.

The reason you must restart `nsd` after making a change to these files is that the `nsd` name service daemon actually takes the contents of `/etc/hosts` and places the contents in its memory cache in a format that is faster to search. Thus, you must restart `nsd` in order for it to see that change and place the new `/etc/hosts` information into RAM cache. If `/etc/nsswitch.conf` is changed, `nsd` must re-read this file so that it knows what type of files (for example, `hosts` or `passwd`) to manage, what services it should call to get information, and in what order those services should be called.

The IP addresses on a running node in the cluster and the IP address of the first node in the cluster cannot be changed while cluster services are active.

- You should be consistent when using fully qualified domain names in the `/etc/hosts` file. If you use fully qualified domain names in `/etc/sys_id` on a particular node, then all of the nodes in the cluster should use the fully qualified name of that node when defining the IP/hostname information for that host in their `/etc/hosts` file.

The decision to use fully qualified domain names is usually a matter of how the clients (such as NFS) are going to resolve names for their client server programs, how their default resolution is done, and so on.

- If you change hostname/IP address mapping for a node in the cluster, you must recreate the node in the configuration database. You must remove the node from the cluster and the database, restart cluster processes on that node, and then define the node and add it to the cluster.
- The `/etc/sys_id` file contains the hostname of the machine and should not be associated with an HA IP address.

## Cluster Database Configuration

When you configure a FailSafe cluster, you will do the following:

1. Verify that the cluster `chkconfig` flag is on.
2. Start the cluster daemons.
3. Determine the hostname of the nodes to be defined as members of the cluster.
4. Configure the database, using the FailSafe Manager GUI or the `cmgr` command:
  - Define the nodes in the pool. Follow the hostname resolution rules in "System File Configuration" on page 69. You should use IP addresses instead of IP names.
  - Define the cluster.
  - Start HA services.
  - Define resources and resource groups.
  - Define failover policies.
  - Define a tiebreaker node.

5. Test the system:
  - Test individual components before starting FailSafe.
  - Test connectivity among the nodes.
  - Test normal operation of the system when FailSafe is running.
  - Simulate failures when FailSafe is running.
6. Use the `build_cmgr_script` command to generate a `cmgr` script based on the contents of the cluster database. As needed, you can then use this generated script to recreate the cluster database after performing a `cdbreinit` when HA services are off. This may be useful for backups or troubleshooting. You should run `build_cmgr_script` again after making significant cluster database changes. Also see the `cdbBackup` command.

For details, see Chapter 6, "Configuration" on page 141.

### Using the Administration Tools

SGI recommends that new users use the FailSafe Manager GUI and the guided tasks. Experienced users can use the `cmgr` command line for repetitive tasks. The GUI provides guided configuration tasks sets and online help; click on any blue text to get more information.

You can launch the GUI with the `fsmgr` command, from the IRIX toolchest, or by entering the following URL on a PC or other workstation, where *server* is the name of an administration node in the pool:

`http://server/FailSafeManager`

(The URL method requires the Java 1.4.1 plug-in.) For more information, see "Starting the GUI and Connecting to a Node" on page 117.

You should perform all FailSafe administration from one node in the pool so that the latest copy of the database will be available even if there are network partitions. You should wait for a change to appear in the details area of the GUI before making another change; if you make changes too quickly, errors can occur.

The `cmgr` command line interface is also provided.

You should make changes from only one instance of the GUI or `cmgr` running at any given time; simultaneous changes made by a second GUI instance (that is, a second

invocation of `fsmgr`) or simultaneous changes made by the GUI and by `cmgr` may overwrite each other.

The FailSafe administration node to which you connect the GUI affects your view of the cluster. You should wait for a change to appear in the *details area* before making another change; the change is not guaranteed to be propagated across the cluster until it appears in the view area. (To see the location of the view and details areas, see Figure 5-1 on page 126.) The entire cluster status information is sent to every FailSafe administration node each time a change is made to the cluster database.

If you are running a coexecution cluster, there is a single cluster database that applies to both FailSafe and CXFS. The `cmgr` command can be used to modify the cluster database for either product, but each product has its own GUI. If a given IRIX administration node applies to both FailSafe and CXFS, you should ensure that any modifications you make to its definition in the database are appropriate for both products.

### Determining the Number of Pools

The number of clusters and pools you define depends upon your failover policies. Each pool contains a single cluster and is unrelated to other pools; only one FailSafe cluster can be present in a pool.

Suppose you have four nodes (A, B, C, D), with two failover pairs (A/B and C/D):

- If the applications running on A or B are never intended to run on C or D (and vice versa), then it is better to set up two independent clusters in separate pools. In this case, you could log into A and define nodes A and B (forming the first pool), and define cluster AB. You would then log into C and define nodes C and D (forming the second pool), and define cluster CD. There is no interrelationship between cluster AB and cluster CD; they are in separate pools. The pools should have separate networks.
- If the applications running on A/B might at some point run on nodes C or D, then all four nodes should be configured as one cluster within a single pool.

### Node Names

The first node you define must be the node that you have logged into.

Once a node has been defined, you cannot change its name or node ID in the cluster database. To use a different name or ID, you must delete it and redefine it. This also applies to cluster names and IDs.

### Issues with a Two-Node Cluster

If you have a two-node cluster, you should create an emergency failover policy for each node in preparation for a time when it may need to run by itself. This situation can occur if the other must stay down for maintenance or if it fails and cannot be brought up. Without these emergency failover policies and the appropriate set of procedures, the surviving node will never form a cluster by itself. For procedures, see "Two-Node Clusters: Single-Node Use" on page 292

### Determining Which Nodes Perform Resets

The Etherlite multiplexer hardware is capable of performing a reset from any node, but the FailSafe software requires that you name a system controller owner node when defining a node. Only that owner node defined in the cluster database may perform the reset. Serial cables must physically connect the node being defined and the owner node through the system controller port.

### Network Interface and Hostnames vs IP Addresses

Although it is possible to enter a hostname in the network interface field when defining a node, this requires DNS on the nodes; it is recommended that you enter an IP address in dot notation instead.

### Appropriate Timeout Determination

An inappropriate node timeout will result in false failovers. An appropriate value will take time to determine; this can be the most difficult part of the FailSafe configuration process.

The timeout must be at least 5 seconds and must also be at least 10 times the heartbeat interval.

Use Performance Co-Pilot to determine the appropriate timeout levels for your resource groups.

### Tiebreaker Nodes

In a cluster where the nodes are of different sizes and capabilities, the largest node in the cluster with the most important application or the maximum number of resource groups should be configured as the tiebreaker node. (By default, the FailSafe tiebreaker is the node with the lowest node ID.)

To set the tiebreaker node, see "Set FailSafe HA Parameters" on page 244.

## Log Files

When you first install FailSafe, you should set logging levels high to obtain enough information for troubleshooting. You must edit the following file to use the appropriate levels:

```
/var/cluster/ha/common_scripts/scriptlib
```

For example, change the log level line from:

```
HA_CURRENT_LOGLEVEL=2
```

to:

```
HA_CURRENT_LOGLEVEL=11
```

The following levels are recommended for each daemon during the testing and configuration process:

```
cli          2
clconfd     5
crsd        13
diags       2
ha_agent    5
ha_cmsd    11
ha_gcd      5
ha_ifd     15
ha_fsd     12
ha_script   5
ha_srmd    13
```

After the system is running satisfactorily, you can reduce the log levels if the log files are filling too quickly.

For more information, see "Set Log Configuration" on page 246.

## Offline Detach Issues

Performing an `offline_detach` operation on a resource group leaves the resources in the resource group running on the node. FailSafe does not track these resources any longer.

Because FailSafe is no longer monitoring the group after the `offline_detach` (or `offline_detach_force`) is executed, it must recover on the same node where it was running at the time the `offline_detach` was performed. You must not allow resources to run on multiple nodes in the cluster.

This also means that no other nodes should be allowed to rejoin the FailSafe membership, especially if `Auto_Recovery` is set in the resource group's failover policy. This restriction is required because the failover policy scripts are run whenever there is a change in membership; rerunning the scripts could cause your previously offline detached resource group to start on a node other than the node where the `offline_detach` was performed.

FailSafe policy scripts are run only on nodes where FailSafe is running (that is, nodes where HA services have been started). For example, suppose you have a four-node FailSafe cluster (with nodes A, B, C and D), where nodes A, B, and C are in UP state and node D is DOWN state. If resource group RG is made offline using the `offline_detach` or `offline_detach_force` command on node B and HA services are shutdown on node B, node D should not rejoin the cluster before resources in RG are stopped manually on node B. If node D rejoins the cluster, the resource group RG will be made online on nodes A, C or D.

## Testing the Configuration

Test the system in three phases:

- Test individual components prior to starting FailSafe software
- Test normal operation of the system
- Simulate failures to test the operation of the system after a failure occurs

During the first few weeks of operation, examine the failovers of each resource group to determine if they are due to inappropriately short timeout values; adjust the timeout values as needed.

---

**Note:** Performing a backup of the entire system may add stress to the system. You should consider this when determining resource group timeouts in order to avoid unnecessary failovers.

---

See Chapter 9, "Testing the Configuration" on page 337.



## Administration and Operation

This section covers best practices for the following:

- "Appropriate Dependencies for `filesystem` Resources" on page 77
- "Enabling System Accounting" on page 78
- "Origin 300, Origin 3200C, Onyx 300, and Onyx 3200C Console Support" on page 78
- "Creating an Emergency Failover Policy for a Two-Node Cluster" on page 79
- "Interrupting FailSafe Commands" on page 79
- "Monitoring System Status" on page 80
- "System Maintenance" on page 80
- "Understanding What Happens After a System Crash or Hang" on page 81
- "Cluster Database Backup and Restore" on page 81
- "Log File Management" on page 82
- "Networking" on page 82
- "Security" on page 83
- "Tuning" on page 83
- "Large Filesystems" on page 83

### Appropriate Dependencies for `filesystem` Resources

SGI recommends that you add an `XVM` or `volume` resource dependency for a given instance of a `filesystem` resource. This will prevent errors when resources are added to or deleted from resource groups.

For more information, see "Dependency" on page 12 and "Add/Remove Dependencies for a Resource Definition" on page 217.

## Enabling System Accounting

Process accounting data is useful when diagnosing FailSafe problems. Therefore, you should enable either extended accounting or Comprehensive System Accounting on all production servers, even if you have no need to bill users for their time.

---

**Note:** Standard SVR4 accounting is not useful for diagnostic purposes because it does not record process ID (PID) information in the process accounting record.

---

For example, the `monitor` action script usually consists of a sequence of operating system commands that probe the status of a resource in different ways. The underlying problem causing a `monitor` action script timeout may be completely different depending on which of these commands caused the timeout. Typically, one specific command will consume the majority of time spent in the script. Backtracking this by examining process accounting data can provide valuable insight that will improve your ability to diagnose timeout problems.

To perform this type of accounting data analysis, you must enable process level accounting data collection on your FailSafe systems before the problem occurs.

For instructions, see *IRIX Admin: Resource Administration*.

## Origin 300, Origin 3200C, Onyx 300, and Onyx 3200C Console Support

On Origin 300, Origin 3200C, Onyx 300, and Onyx 3200C systems, there is only one serial/USB port that provides both L1 system controller and console support for the machine. In a FailSafe configuration, this port (the DB9 connector) is used for system reset. It is connected to a serial port in another node or to the Ethernet multiplexer.

To get access to console input and output, you must redirect the console to another serial port in the machine.



---

**Caution:** Redirecting the console works only when IRIX is running. To access the console when IRIX is not running (miniroot), you must physically reconnect the machine: unplug the serial hardware reset cable from the console/L1 port and then connect the console cable.

---

For instructions, see "Redirecting the Console for Origin 300, Origin 3200C, Onyx 300, and Onyx 3200C" on page 291.

## Creating an Emergency Failover Policy for a Two-Node Cluster

If you have a two-node cluster, you should create an emergency failover policy for each node in preparation for a time when it may need to run by itself. This situation can occur if the other must stay down for maintenance or if it fails and cannot be brought up.



---

**Caution:** Without these emergency failover policies and the appropriate set of procedures, the resources cannot come online because half or more of the failover domain is down.

---

For instructions about using a single node and resuming two-node use, see "Two-Node Clusters: Single-Node Use" on page 292.

## Interrupting FailSafe Commands

After a FailSafe command is started, it may partially complete even if you interrupt the command by typing `Ctrl-c`. If you halt the execution of a command this way, you may leave the cluster in an indeterminate state and you may need to use the various status commands to determine the actual state of the cluster and its components.

## Monitoring System Status

While the FailSafe system is running, you can monitor the status of the FailSafe components to determine the state of the component. FailSafe allows you to view the system status in the following ways:

- Keep watch on the state of a cluster using the `cluster_status` command or the GUI.
- Query the status of an individual resource group, node, or cluster using either the GUI or the `cmgr` command. These tools also display the heartbeat network that is currently being used.
- Use the `haStatus` script provided with the `cmgr` command to see the status of all clusters, nodes, resources, and resource groups in the configuration.
- Use the Embedded Support Partner (ESP), which consists of a set of daemons that perform various monitoring activities. You can choose to configure ESP so that it will log FailSafe events (the FailSafe ESP event profile is not configured in ESP by default).

For details, see "System Status" on page 297.

## System Maintenance

To perform system maintenance, do the following.

---

**Note:** You must wait for each step to complete before moving to the next step.

---

1. Manually move the resource group to the backup system.
2. Shut down HA services on the target system.
3. Shut down cluster services on the target system.
4. Perform the maintenance activity.
5. Restart cluster services on the target system.
6. Restart HA services on the target system.
7. Manually move the resource group back to the target system.

## Understanding What Happens After a System Crash or Hang

Following is what happens after the system crashes or hangs:

1. The crashed system begins a dump and reboot.

---

**Note:** A system with a lot of memory may require a very long heartbeat timeout in order to be able to get a useful dump.

---

2. FailSafe detects that the system is not responsive because there is no heartbeat within the node-timeout interval (1 minute by default).
3. FailSafe issues a system reset across the serial line.
4. FailSafe forces the failover of the resource groups on the crashed system to the backup system(s).
5. The formerly crashed system reboots.
6. The resource groups move back to the original system only if `auto_failback` is the failover attribute.

## Cluster Database Backup and Restore

You should perform a cluster database backup whenever you want to save the database and be able to restore it to the current state at a later point.

You can use the following methods to restore the database:

- If the database is accidentally deleted from a node, use the `fs2d` daemon to replicate the database from another node in the pool.
- If you want to be able to recreate the current configuration, use the `build_cmgr_script` script. You can then recreate this configuration by running the script generated.
- If you want to retain a copy of the database and all node-specific information such as log configuration, resource definitions, and resource type definitions, use the `cdbBackup` and `cdbRestore` commands. If `cdbBackup` is not available, you should make the modifications before bringing resource groups online.

For details, see "Cluster Database Backup and Restore" on page 325, and "Filesystem Dump and Restore" on page 329.

## Log File Management

You should not change the names of the log files. If you change the names of the log files, errors can occur.

If you are having problems with disk space, you may want to choose a less verbose log level.

You should rotate the log files at least weekly so that your disk will not become full.

You can run the `/var/cluster/cmgr-scripts/rotatelogs` script to copy all files to a new location. This script saves log files with the day and the month name as a suffix. If you run the script twice in one day, it will append the current log file to the previous saved copy.

By default, the `rotatelogs` script will be run by `crontab` once a week, which is sufficient if you use the default log levels. If you plan to run with a high debug level for several weeks, you should reset the `crontab` entry so that the `rotatelogs` script is run more often.

On heavily loaded machines, or for very large log files, you may want to move resource groups and stop HA services before running `rotatelogs`.

For more information, see "Rotating Log Files" on page 329, and "Set Log Configuration" on page 246.

## Networking

### Fix Networking Problems First

If there are any network issues on the private network, fix them before trying to use FailSafe.

### Improve Availability by using UDP

To improve availability during a failover, clients should connect to the HA server using UDP not TCP. If TCP is used, clients will have to reconnect to the server.

## NFS

The FailSafe for NFS plug-in provides failover protection for filesystems and directories that are exported using NFS.

In a FailSafe cluster, one or more nodes can export NFS resources. A resource group can contain multiple NFS resources and a single node in the cluster may have multiple resource groups that contain NFS resources. If a node that exports NFS resources fails, another node provides backup service.

For more information about NFS, see *IRIX FailSafe NFS Administrator's Guide*.

## Security

For a secure connection when logging in to the FailSafe GUI, choose **Remote Shell** and type a secure connection command using a utility such as `ssh`. Otherwise, the GUI will not encrypt communication and transferred passwords will be visible to users of the network. For more information, see "Logging In" on page 119.

## Tuning

Performance Co-Pilot FailSafe metrics are useful for tuning FailSafe, especially in times of ongoing degraded performance. For more information, see Chapter 12, "Performance Co-Pilot for FailSafe" on page 381.

## Large Filesystems

Running with too many filesystem allocation groups can lead to buffer congestion. This can result in processes appearing to hang, and can result in inappropriate failovers.

If your site has large filesystems, you should run the `mkfs` command on each filesystem after installing IRIX 6.5.13 or later in order to reduce the number of allocation groups per filesystem. As of IRIX 6.5.13, the default allocation group size for filesystems greater than 65 Gbytes is 4 Gbytes.

## CXFS and DMF, NFS, and Samba Resource Types

The DMF resource type requires that the CXFS resource on which it depends has the `relocate-mds` flag set to `true`.

Although NFS and Samba perform better when run from the CXFS active metadata server, these resource types do not strictly require that the CXFS resource on which

they may depend to have the CXFS plug-in `relocate-mds` flag set to `true`. (The default value for the flag is `false`.)

---

**Note:** If you set `relocate-mds` to `true`, the server list specified for the CXFS filesystem must match the FailSafe failover domain for the resource group that contains the CXFS resource.

---

## Avoiding Problems

This section covers the following:

- "Proper Start Up" on page 84
- "Cluster Database Membership Quorum Stability" on page 84
- "Consistency in Configuration" on page 85
- "Log File Names and Sizes" on page 85
- "Removing Unused Nodes" on page 85

## Proper Start Up

Ensure that you follow the installation and system preparation instructions in Chapter 4, "FailSafe Installation and System Preparation" on page 87, before configuring the cluster.

## Cluster Database Membership Quorum Stability

The cluster database membership quorum must remain stable during the configuration process. If possible, use multiple windows to display the `fs2d_log` file for each node while performing configuration tasks. Enter the following:

```
# tail -f /var/cluster/ha/log/fs2d_log
```

Check the member count when it prints new quorums. Under normal circumstances, it should print a few messages when adding or deleting nodes, but it should stop within a few seconds after a new quorum is adopted.



If not enough nodes respond, there will not be a quorum. In this case, the database will not be propagated.

If you detect cluster database membership quorum problems, fix them before making other changes to the database. Try restarting the cluster infrastructure daemons on the node that does not have the correct cluster database membership quorum, or on all nodes at the same time. Enter the following:

```
# /etc/init.d/cluster stop  
# /etc/init.d/cluster start
```

Please provide the `fs2d` log files when reporting a cluster database membership quorum problem.

## Consistency in Configuration

Be consistent in configuration files for nodes across the pool, and when configuring networks. Use the same names in the same order.

## GUI Use

The GUI provides a convenient display of a cluster and its components through the view area. You should use it to see your progress and to avoid adding or removing nodes too quickly. After defining a node, you should wait for it to appear in the view area before adding another node. After defining a cluster, you should wait for it to appear before you add nodes to it. If you make changes too quickly, errors can occur.

When running the GUI on IRIX, do not move to another IRIX desktop while GUI action is taking place; this can cause the GUI to crash.

## Log File Names and Sizes

Periodically, you should rotate log files to avoid filling your disk space.

## Removing Unused Nodes

If a node is going to be down for a while, remove it from the cluster and the pool to avoid cluster database membership problems.



## FailSafe Installation and System Preparation

---

**Note:** The procedures in this chapter assume that you have done the work described in Chapter 2, "Configuration Planning" on page 31.

---

The following steps are required for FailSafe installation and system preparation:

- "Install FailSafe"
- "Configure System Files" on page 92
- "Set the `corepluspid` System Parameter" on page 98
- "Set NVRAM Variables" on page 98
- "Create XLV Logical Volumes and XFS Filesystems" on page 98
- "Configure Network Interfaces" on page 100
- "Configure the Ring Reset Serial Port" on page 104
- "Install Patches" on page 105
- "Install Performance Co-Pilot Software" on page 109
- "Test the System" on page 113

### Install FailSafe

This section discusses the following:

- "Install Procedure"
- "Differences When Performing a Remote or Miniroot Install" on page 91

### Install Procedure

Installing the FailSafe base CD requires about 10 MB of free space.

To install the required software, do the following:

1. On each node in the pool, upgrade to a supported release of IRIX according to the *IRIX 6.5 Installation Instructions* and the FailSafe product release notes:

```
# relnotes failsafe2 [chapter_number]
```

To verify that a given node has been upgraded, use the following command to display the currently installed system:

```
# uname -aR
```

2. Depending on the servers and storage in the configuration and the IRIX revision level, install the latest recommended patches. For information on recommended patches for each platform, see:  
<http://bits.csd.sgi.com/digest/patches/recommended/>
3. On each node, install the version of the serial port server driver that is appropriate to the operating system. Use the CD that accompanies the serial port server. Reboot the system after installation.

For more information, see the following documentation provided with the serial port server:

- *EL Serial Port Server Installation Guide* (provided by Digi Corporation)
- *EL Serial Port Server Installation Guide Errata*

4. On each node, install the following software, in the order shown:

```
sysadm_base.sw.dso  
sysadm_base.sw.server  
sysadm_cluster.sw.server  
cluster_admin.sw.base  
cluster_control.sw.base  
cluster_services.sw.base  
cluster_services.sw.cli  
failsafe2.sw  
sysadm_failsafe2.sw.server
```

When `sysadm_base` is installed, `tcpmux` service is added to the `/etc/inetd.conf` file.

---

**Note:** For systems that do not have `sysadmdesktop` installed, `inst` reports missing prerequisites. Resolve this conflict by installing `sysadm_base.sw.priv`, which provides a subset of the functionality of `sysadmdesktop.sw.base` and is included in this distribution, or by installing `sysadmdesktop.sw.base` from the IRIX distribution.

---

If you try to install `sysadm_base.sw.priv` on a system that already has `sysadmdesktop.sw.base`, `inst` reports incompatible subsystems. Resolve this conflict by not installing `sysadm_base.sw.priv`. Similar conflicts occur if you try to install `sysadmdesktop.sw.base` on a system that already has `sysadm_base.sw.priv`.

If the nodes are to be administered by a web-based version of the GUI, install these subsystems, in the order shown:

```
java2_eoe.sw
java2_eoe.sw32
sysadm_base.sw.client
sysadm_cluster.sw.client
sysadm_failsafe2.sw.client
sysadm_failsafe2.sw.web
```



**Caution:** The GUI only operates with Java2 v1.4.1 Execution Environment (Sun JRE v1.4.1). This is the version of Java that is provided with the IRIX 6.5.x release.

The SGI website also contains Java 1. However, you cannot use this version of Java with the GUI. Using a Java version other than 1.4.1 will cause the GUI to fail.

---

5. On each node, install application software and appropriate optional FailSafe plug-in software. For example, for NFS install the following:

```
nfs.sw.nfs (If necessary; from IRIX, might already be present)
failsafe2_nfs.sw
```

6. If you want to run the administrative workstation (GUI client) from an IRIX desktop, install the following subsystems on the desktop:

```
sysadm_failsafe2.sw.desktop
sysadm_failsafe2.sw.client
sysadm_base.sw.client
sysadm_cluster.sw.client
java2_eoe.sw
java2_eoe.sw32
```

If the administrative workstation is an IRIX machine that launches the GUI client from a web browser that supports Java, install the 1.4.1 `java_plugin` from the IRIX applications CD. (However, launching the GUI from a Web browser is not the recommended method on IRIX; on IRIX it is better to invoke the `fsmgr` command.)

After installing the Java plug-in, you must close all browser windows and restart the browser.

7. On the appropriate nodes, install other optional software, such as storage management or network board software.
8. If the cluster is using plexed XLV logical volumes, do the following:
  - a. Install a disk plexing license on each node in the `/var/flexlm/license.dat` file. For more information on XLV logical volumes and on XFS plexing and filesystems, see Chapter 2, "Configuration Planning".
  - b. Verify that the license has been successfully installed on each node in the cluster by using the `xlvmgr` command:

```
# xlvmgr
xlvmgr> show config
```

If the license is successfully installed, the following line appears:

```
Plexing license: present
```

- c. Quit `xlvmgr`.
9. Install recommended patches for FailSafe.

For instructions on installing a FailSafe patch, see "Install Patches" on page 105.

10. Set the `AutoLoad` variable to `Yes`; this can be done when you set host SCSI IDs, as explained in "Set NVRAM Variables" on page 98.

---

**Note:** For reference, Appendix A, "FailSafe Software" on page 387, summarizes systems to install on each component of a cluster or node.

---

## Differences When Performing a Remote or Miniroot Install

If you perform a remote or miniroot install, the `exitop` commands will be deferred until cluster services are started, at which time the `exitop` commands will be run. While performing the installation, you will see `can't run remotely` messages among the normal set of messages. For example:

```
Removing orphaned directories
Installing/removing files .. 94%
Running exit-commands .. 94%
cluster_admin.sw.base: ( $rbase/usr/cluster/bin/cdb-exitop )
cdb-exitop: can't run remotely - scheduling to run later
Running exit-commands .. 95%
cluster_control.sw.base: ( $rbase/usr/cluster/bin/cluster_control-exitop )
cluster_control-exitop: can't run remotely - scheduling to run later
Running exit-commands .. 96%
cluster_services.sw.base: ( $rbase/usr/cluster/bin/cluster_ha-exitop )
cluster_ha-exitop: can't run remotely - scheduling to run later
Running exit-commands .. 97%
cxfs_cluster.sw.base: ( $rbase/usr/cluster/bin/cluster_cx-exitop )
cluster_cx-exitop: can't run remotely - scheduling to run later
Running exit-commands .. 99%
Checking dependencies .. 100% Done.
Installations and removals were successful.
You may continue with installations or quit now.
```

If you see the above messages during the install process, you will see the following messages when the cluster services start up:

```
running /usr/cluster/bin/cdb-exitop
cdb-exitop: initializing CDB
cdb-exitop: success
running /usr/cluster/bin/cluster_control-exitop
cluster_control-exitop: success
```

```
running /usr/cluster/bin/cluster_ha-exitop
cluster_ha-exitop: Added HA keys to /var/cluster/cdb/cdb.db
```

```
* * * * * I M P O R T A N T * * * * *
```

```
"sgi-cmsd" service MUST be added to /etc/services.
Restart cluster processes after adding the entry. Failure to do so
will cause cluster and FailSafe services to function incorrectly.
Please refer to the SGI FailSafe Administrator's Guide for more
information.
```

```
* * * * * I M P O R T A N T * * * * *
```

```
"sgi-gcd" service MUST be added to /etc/services.
Restart cluster processes after adding the entry. Failure to do so
will cause cluster and FailSafe services to function incorrectly.
Please refer to the SGI FailSafe Administrator's Guide for more
information.
```

```
cluster_ha-exitop: success
running /usr/cluster/bin/cluster_cx-exitop
cluster_cx-exitop: Added CXFS keys to /var/cluster/cdb/cdb.db
cluster_cx-exitop: success
```

## Configure System Files

This section discusses the following:

- `/etc/services`
- `/etc/config/cad.options` on page 93
- `/etc/config/fs2d.options` on page 94
- `/etc/config/cmond.options` on page 97

Also see the best-practices information in "System File Configuration" on page 69.



## **/etc/services**

Edit the `/etc/services` file so that it contains entries for `sgi-cad` and `sgi-crsd` before you install the `cluster_admin` product on each node in the pool. The port numbers assigned for these processes must be the same in all nodes in the pool.

---

**Note:** `sgi-cad` requires a TCP port for communication between FailSafe nodes.

---

The following shows an example of `/etc/services` entries for `sgi-cad` and `sgi-crsd`:

```
sgi-crsd      7500/udp      # Cluster Reset Services Daemon
sgi-cad       9000/tcp      # Cluster Admin daemon
```

Edit the `/etc/services` file so that it contains entries for `sgi-cmsd` and `sgi-gcd` on each node before starting highly available (HA) services on the node. The port numbers assigned for these processes must be the same in all nodes in the cluster.

The following shows an example of `/etc/services` entries for `sgi-cmsd` and `sgi-gcd`:

```
sgi-cmsd      7000/udp      # FailSafe Membership Daemon
sgi-gcd       8000/udp      # Group Communication Daemon
```

## **/etc/config/cad.options**

The `/etc/config/cad.options` file contains the list of parameters that the `cad` cluster administration daemon reads when the process is started. `cad` provides cluster information to the GUI.

The following options can be set in the `cad.options` file:

```
--append_log      Append cad logging information to the cad log file
                  instead of overwriting it.
--log_file filename  cad log file name. Alternately, this can be specified as
                  -lf filename.
-vvvv           Verbosity level. The number of v characters indicates
                  the level of logging. Setting -v logs the fewest
```

messages. Setting `-vvvv` logs the highest number of messages.

The following example shows an `/etc/config/cad.options` file:

```
-vv -lf /var/cluster/ha/log/cad_nodename --append_log
```

The contents of the `/etc/config/cad.options` file cannot be modified using the `cmgr` command or the GUI.

---

**Note:** If you make a change to the `cad.options` file at any time other than initial configuration, you must restart the `cad` processes in order for these changes to take effect. You can do this by rebooting the nodes or by entering the following command:

```
# /etc/init.d/cluster restart
```

If you execute this command on a running cluster, it will remain up and running. However, the GUI will lose connection with the `cad` daemon; the GUI will prompt you to reconnect.

---

### `/etc/config/fs2d.options`

The `/etc/config/fs2d.options` file contains the list of parameters that the `fs2d` daemon reads when the process is started. The `fs2d` daemon is the cluster database daemon that manages the distribution of the cluster database across the nodes in the pool.

Table 4-1 shows the options can that can be set in the `fs2d.options` file.

**Table 4-1** fs2d.options File Options

Option	Description
-logevents <i>event name</i>	Log selected events. The following event names may be used: all, internal, args, attach, chandle, node, tree, lock, datacon, trap, notify, access, storage. The default is all.
-logdest <i>log destination</i>	Set log destination. The following log destinations may be used: all, stdout, stderr, syslog, logfile. If multiple destinations are specified, the log messages are written to all of them. If logfile is specified, it has no effect unless the -logfile option is also specified. The default is logfile.
-logfile <i>filename</i>	Set log filename. The default is /var/cluster/ha/log/fs2d_log.
-logfilemax <i>maximum size</i>	Set log file maximum size (in bytes). If the file exceeds the maximum size, any preexisting filename.old will be deleted, the current file will be renamed to filename.old, and a new file will be created. A single message will not be split across files. If -logfile is set, the default is 1000000.
-loglevel <i>loglevel</i>	Set log level. The following log levels may be used: always, critical, error, warning, info, moreinfo, freq, morefreq, trace, busy. The default is info.
-trace <i>trace_class</i>	Trace selected events. The following trace classes may be used: all, rpcs, updates, transactions, monitor. If you specify this option, you must also specify -tracefile and/or -tracelog. No tracing is done, even if it is requested for one or more classes of events, unless either or both of -tracefile or -tracelog is specified. The default is transactions.
-tracefile <i>filename</i>	Set trace filename. There is no default.
-tracefilemax <i>maximum_size</i>	Set trace file maximum size (in bytes). If the file exceeds the maximum size, any preexisting filename.old will be deleted, the current file will be renamed to filename.old, and a new file will be created.
-[no]tracelog	[Do not] trace to log destination. When this option is set, tracing messages are directed to the log destination or destinations. If there is also a trace file, the tracing messages are written there as well. The default is -tracelog.
-[no]parent_timer	[Do not] exit when parent exits. The default is -noparent_timer.

Option	Description
-[no]daemonize	[Do not] run as a daemon. The default is <code>-daemonize</code> .
-l	Do not run as a daemon.
-h	Print usage message.
-o help	Print usage message.

If you use the default values for these options, the system will be configured so that all log messages of level `info` or less, and all trace messages for transaction events, are sent to the `/var/cluster/ha/log/fs2d_log` file. When the file size reaches 10 MB, this file will be moved to its namesake with the `.old` extension and logging will roll over to a new file of the same name. A single message will not be split across files.

**Note:** If you make a change to the `fs2d.options` file at any time other than initial configuration, you must restart the `fs2d` processes in order for those changes to take effect. You can do this by rebooting the nodes or by entering the following command:

```
# /etc/init.d/cluster restart
```

If you execute this command on a running cluster, it should remain up and running. However, the GUI will lose connection with the `cad` daemon; the GUI will prompt you to reconnect.

---

### Example 1

The following example shows an `/etc/config/fs2d.options` file that directs logging and tracing information as follows:

- All log events are sent to `/var/adm/SYSLOG`.
- Tracing information for RPCs, updates, and transactions are sent to `/var/cluster/ha/log/fs2d_ops1`.

When the size of this file exceeds 100,000,000 bytes, this file is renamed to `/var/cluster/ha/log/fs2d_ops1.old` and a new file `/var/cluster/ha/log/fs2d_ops1` is created. A single message is not split across files.

(Line breaks added here only for readability.)

```
-logevents all -loglevel trace -logdest syslog -trace rpcs
-trace updates -trace transactions -tracefile /var/cluster/ha/log/fs2d_ops1
-tracefilemax 100000000
```

## Example 2

The following example shows an `/etc/config/fs2d.options` file that directs all log and trace messages into one file, `/var/cluster/ha/log/fs2d_nodeA`, for which a maximum size of 100,000,000 bytes is specified. `-tracelog` directs the tracing to the log file.

(Line breaks added here only for readability.)

```
-logevents all -loglevel trace -trace rpcs -trace updates
-trace transactions -tracelog -logfile /var/cluster/ha/log/fs2d_nodeA
-logfilemax 100000000 -logdest logfile.
```

## `/etc/config/cmond.options`

The `/etc/config/cmond.options` file contains the list of parameters that the `cmond` cluster monitor daemon reads when the process is started. It also specifies the name of the file that logs `cmond` events. `cmond` provides a framework for starting, stopping, and monitoring process groups. See the `cmond` man page for more information.

The following options can be set in the `cmond.options` file:

<code>-L <i>log_level</i></code>	Set log level to <i>log_level</i> . The legal values for <i>log_level</i> are <code>normal</code> , <code>critical</code> , <code>error</code> , <code>warning</code> , <code>info</code> , <code>frequent</code> , and <code>all</code> .
<code>-d</code>	Run in debug mode.
<code>-l</code>	Lazy mode, where <code>cmond</code> does not validate its connection to the cluster database.
<code>-t <i>nap_interval</i></code>	The time interval in milliseconds after which <code>cmond</code> checks for liveness of process groups it is monitoring.
<code>-s</code>	Log messages to standard error.

A default `cmond.options` file is shipped with the following options. This default options file logs `cmond` events to the `/var/cluster/ha/log/cmond_log` file.

```
-L info -f /var/cluster/ha/log/cmond_log
```

## Set the `corepluspid` System Parameter

Use the `sysctl` command to set the `corepluspid` flag to 1 on every node. If this flag is set, IRIX will suffix all core files with a process ID (PID). This prevents a core dump from being overwritten by another process core dump.

## Set NVRAM Variables

During the hardware installation of FailSafe nodes, two non-volatile random-access memory (NVRAM) variables must be set:

- The boot parameter `AutoLoad` must be set to `yes`. FailSafe requires the nodes to be automatically booted when they are reset or when the node is powered on.
- The SCSI IDs of the nodes, specified by the `scsihostid` variable, must be different. This variable is important only when a cluster is configured with shared SCSI storage. If a cluster has no shared storage or is using shared Fibre Channel storage, setting `scsihostid` is not important.

You can check the setting of these variables with the following commands:

```
# nvrAm AutoLoad
Y
# nvrAm scsihostid
0
```

To set these variables, use the following commands:

```
# nvrAm AutoLoad yes
# nvrAm scsihostid number
```

*number* is the SCSI ID you choose. A node uses its SCSI ID on all buses attached to it. Therefore, you must ensure that no device attached to a node has *number* as its SCSI unit number. If you change the value of the `scsihostid` variable, you must reboot the system for the change to take effect.

## Create XLV Logical Volumes and XFS Filesystems

You can create XLV logical volumes by following the instructions in the guide *IRIX Admin: Disks and Filesystems*.

---

**Note:** This section describes logical volume configuration using XLV logical volumes. For information on coexecution of FailSafe and CXFS filesystems (which use XVM logical volumes), see "Coexecution of CXFS and FailSafe" on page 47. For information on creating CXFS filesystems, see the *CXFS Administration Guide for SGI InfiniteStorage*. For information on creating XVM logical volumes, see the *XVM Volume Manager Administrator's Guide*.

---

When you create XLV logical volumes and XFS filesystems, remember the following important points:

- If the shared disks are not in a RAID storage system, you should create plexed XLV logical volumes.
- Each XLV logical volume must be owned by the same node that is the primary node for the resources that use the logical volume. To simplify the management of the owners of volumes on shared disks, use the following recommendations:
  - Work with the volumes on a shared disk from only one node in the cluster.
  - After you create all the volumes on one node, you can selectively change the *nodename* to the other node using `xlv_mgr`.
- If the XLV logical volumes you create are used as raw volumes (that is, with no filesystem) for storing database data, the database system may require that the device names (in `/dev/rxlv` and `/dev/xlv`) have specific owners, groups, and modes. If this is the case (see the documentation provided by the database vendor), use the `chown` and `chmod` commands to set the owner, group, and mode as required.
- No filesystem entries are made in `/etc/fstab` for XFS filesystems on shared disks; FailSafe software mounts the filesystems on shared disks. However, to simplify system administration, consider adding comments to `/etc/fstab` that list the XFS filesystems configured for FailSafe. Thus, a system administrator who sees mounted FailSafe filesystems in the output of the `df` command and looks for the filesystems in the `/etc/fstab` file will learn that they are filesystems managed by FailSafe.
- Be sure to create the mount point directory for each filesystem on all nodes.

## Configure Network Interfaces

This section describes how to configure the network interfaces. The example shown in Figure 4-1 is used in the procedure.

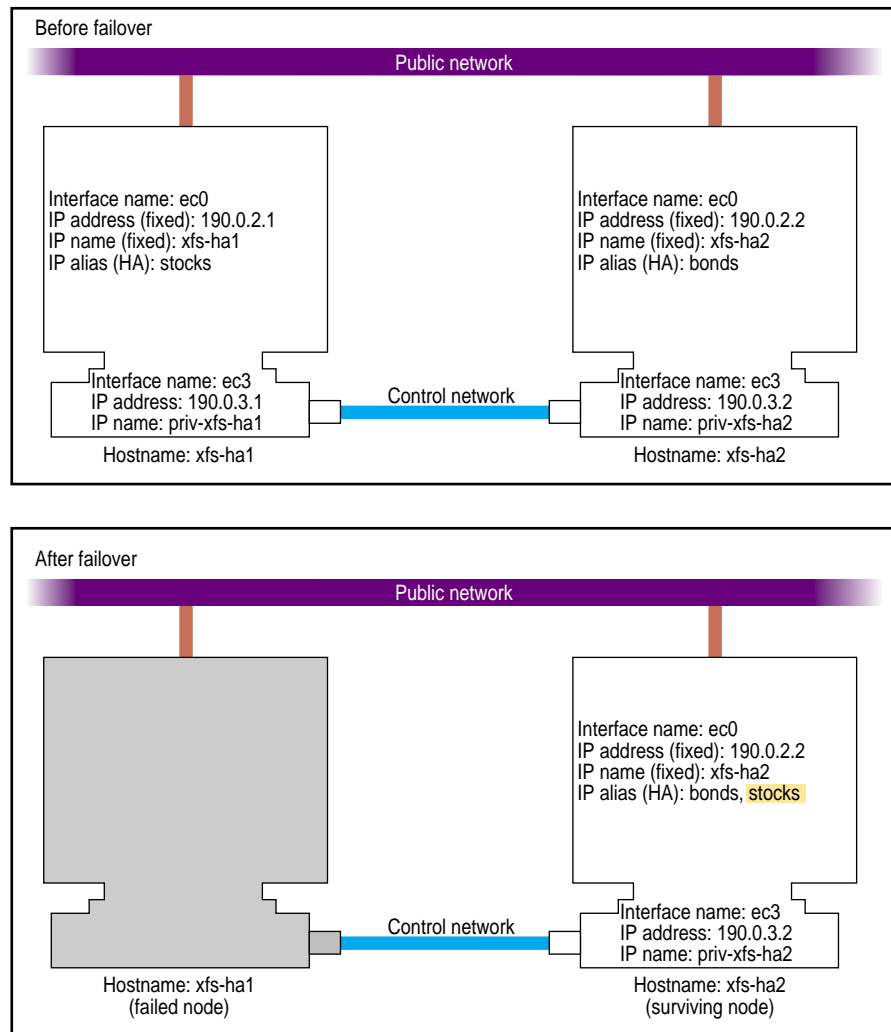

Figure 4-1 Example Interface Configuration



1. If possible, add every IP address, IP name, and highly available (HA) IP address (alias) for the nodes to `/etc/hosts` on one node.

For example:

```
190.0.2.1 xfs-ha1.company.com xfs-ha1
190.0.2.3 stocks
190.0.3.1 priv-xfs-ha1
190.0.2.2 xfs-ha2.company.com xfs-ha2
190.0.2.4 bonds
190.0.3.2 priv-xfs-ha2
```

---

**Note:** HA IP addresses that are used exclusively by HA services are not added to the file `/etc/config/ipaliases.options`. Similarly, if all IP aliases are used only by HA services, the `ipaliases chkconfig` flag should be `off`.

---

2. Add all of the IP addresses from step 1 to `/etc/hosts` on the other nodes in the cluster.
3. If there are IP addresses, IP names, or HA IP addresses that you did not add to `/etc/hosts` in steps 1 and 2, verify that NIS is configured on all nodes by entering the following command on each node:

```
# chkconfig | grep yp
...
           yp           on
```

If the output shows that `yp` is `off`, you must start NIS. See the *NIS Administrator's Guide* for details.

4. For IP addresses, IP names, and HA IP addresses that you did not add to `/etc/hosts` on the nodes in steps 1 and 2, verify that they are in the NIS database by entering the following command for each address:

```
# ypmatch address hosts
190.0.2.1 xfs-ha1.company.com xfs-ha1
```

*address* is an IP address, IP name, or HA IP address. If `ypmatch` reports that *address* does not match, it must be added to the NIS database. See the *NIS Administrator's Guide* for details.

5. On one node, add that node's interfaces and their IP addresses to the file `/etc/config/netif.options`. However, highly available (HA) IP addresses are not added to the `netif.options` file.

For the example in Figure 4-1, the public interface name and IP address lines are as follows:

```
if1name=ec0
if1addr=$HOSTNAME
```

`$HOSTNAME` is an alias for an IP address that appears in `/etc/hosts`.

If there are additional public interfaces, their interface names and IP addresses appear on lines such as the following:

```
if2name=
if2addr=
```

In the example, the control network name and IP address are as follows:

```
if3name=ec3
if3addr=priv-$HOSTNAME
```

The control network IP address in this example, `priv-$HOSTNAME`, is an alias for an IP address that appears in `/etc/hosts`.

6. If there are more than eight interfaces on the node, change the value of `if_num` to the number of interfaces. For fewer than eight interfaces (as in the example in Figure 4-1), the line is as follows:

```
if_num=8
```

7. Repeat Steps 5 and 6 on the other nodes.
8. Edit the `/etc/config/routed.options` file on each node so that the routes are not advertised over the control network. See the `routed` man page for a list of options.

For example:

```
-q -h -Prdisc_interval=45
```

---

**Note:** The `-q` option is required for FailSafe to function correctly. This ensures that the heartbeat network does not get loaded with packets that are not related to the cluster.

---

The options do the following:

- Turn off advertising of routes
  - Cause host or point-to-point routes to not be advertised (provided there is a network route going the same direction)
  - Set the normal interval with which router discovery advertisements are transmitted to 45 seconds (and their lifetime to 135 seconds)
9. Verify that FailSafe 2.x is turned off on each node, using the `chkconfig` command:

```
# chkconfig | grep failsafe2
...
           failsafe2           off
...
```

If `failsafe2` is set to on on a node, enter this command on that node:

```
# chkconfig failsafe2 off
```

If `Failsafe 1.x` is present, you must also ensure that it is not configured on for any node:

```
# chkconfig | grep failsafe
...
           failsafe           off
...
```

If `failsafe` is on on any node, enter this command on that node:

```
# chkconfig failsafe off
```

10. Configure an e-mail alias on each node that sends the FailSafe e-mail notifications of cluster transitions to a user outside of the cluster and to a user on the other nodes in the cluster.

For example, if there are two nodes called `xfs-ha1` and `xfs-ha2`, add the following to `/usr/lib/aliases` on `xfs-ha1`:

```
fSAFE_admin:operations@console.xyz.com,admin_user@xfs-ha2.xyz.com
```

On `xfs-ha2`, add the following line to `/usr/lib/aliases`:

```
fSAFE_admin:operations@console.xyz.com,admin_user@xfs-ha1.xyz.com
```

The alias you choose, `fSAFE_admin` in this case, is the value you will use for the mail destination address when you configure your system. In this example, `operations` is the user outside the cluster and `admin_user` is a user on each node.

11. If the nodes use NIS — that is, `yp` has been set to on using `chkconfig` — or the BIND domain name server (DNS), switching to local name resolution is recommended. Modify the `/etc/nsswitch.conf` file so that it reads as follows:

```
hosts:                files nis dns
```

---

**Note:** Exclusive use of NIS or DNS for IP address lookup for the nodes has been shown to reduce availability in situations where the NIS service becomes unreliable.

---

12. If you are using FDDI, finish configuring and verifying the new FDDI station, as explained in the FDDIXpress release notes and the *FDDIXpress Administration Guide*.
13. Reboot all nodes to put the new network configuration into effect.

## Configure the Ring Reset Serial Port

When using a ring reset configuration, you must turn off the `getty` process for the tty ports to which the reset serial cables. . Perform the following steps on each node:

1. Determine which port is used for the reset serial line.
2. Open the file `/etc/inittab` for editing.
3. Find the line for the port by looking at the comments on the right for the port number from step 1.

4. Change the third field of this line to `off`. For example:

```
t2:23:off:/sbin/getty -N ttyd2 co_9600          # port 2
```

5. Save the file.
6. Enter these commands to make the change take effect:

```
# killall getty
# init q
```

## Install Patches

The procedures in this section describe how to install a FailSafe patch. The patch should be installed on all nodes.

### Installing FailSafe 2.x and a FailSafe Patch at the Same Time

When you install FailSafe 2.x images and an upgrade patch together, the cluster processes must be stopped and started on each node after patch installation. This is because the FailSafe 2.x installation automatically starts the cluster processes and the patch installation does not automatically stop them, so the cluster processes will continue to run the unpatched shared libraries unless you restart them.

Do the following on each node:

1. Install FailSafe 2.x images on the node. This includes the following products:

```
cluster_admin
cluster_control
cluster_services
failsafe2
sysadm_base
sysadm_failsafe2
```

2. Install the FailSafe 2.x patch.
3. In a UNIX shell, stop all cluster processes on the node:

```
# /etc/init.d/cluster stop
```

4. Verify that the cluster processes (`cad`, `cmond`, `crsd`, and `fs2d`) have stopped:

```
# ps -ef | egrep '(cad|cmond|crsd|fs2d)'
```

5. Start cluster processes on the node:

```
# /etc/init.d/cluster start
```

You are now ready to run the FailSafe Manager GUI or the `cmgr` command to set up a FailSafe cluster.

## Installing a FailSafe Patch on an Existing FailSafe 2.x Cluster

Using these instructions, you can install a FailSafe patch on each FailSafe 2.x node in turn, without shutting down the entire cluster and without interrupting the HA services provided by the cluster.

---

**Note:** Before installing a FailSafe patch, you should read the patch's release notes. These release notes may contain special instructions that are not provided in this procedure.

---

To install a FailSafe patch on each node in your FailSafe cluster, follow these steps:

1. If you have the FailSafe GUI client software installed on a machine that is not a node, first install the patch client subsystems on that machine. The GUI client software subsystems are as follows, where `xxxxxx` is the patch number:

```
patchSGxxxxxx.sysadm_base_sw.client
patchSGxxxxxx.sysadm_failsafe2_sw.client
patchSGxxxxxx.sysadm_failsafe2_sw.desktop
```

2. Choose a node on which to install the patch. Start up the FailSafe GUI or `cmgr` command on that node.

For convenience, connect the GUI to a node that you are **not** upgrading.

---

**Note:** If you connect to the node that you are upgrading, then in a later step (when you stop HA services), FailSafe will no longer report accurate status to the GUI; in another later step (when you stop cluster services), the GUI will lose its connection.

---

Use the following `cmgr` command to specify a default node (later commands in this procedure assume the cluster name has already been set):

```
cmgr> set cluster clustername
```

3. (Optional) If you wish to keep all resource groups running on the node during installation, take the resource groups offline using the `detach` option (that is, detach the resource groups). If you do this, FailSafe will stop monitoring the resources, which will continue to run on the node, and will not have any control over the resource groups. Otherwise, in the next step, the resources should migrate to another node automatically, assuming the failover policy is defined that way.

If you are using the GUI, run the **Take Resource Group Offline** task and check the **Detach Only** checkbox.

If you are using `cmgr`, execute the following command:

```
cmgr> admin offline_detach resource_group groupname
```

4. Stop HA services on the node. (When HA services stop, FailSafe will no longer be able to report current cluster and node state if the FailSafe GUI is connected to that node. To monitor the cluster state during installation, connect the FailSafe GUI to the node that you are not upgrading.)

If you are using the GUI, run the **Stop FailSafe HA Services** task, specifying the node you are patching in the **One Node Only** field.

If you are using `cmgr`, execute the following command:

```
cmgr> stop ha_services on node nodename
```

If you skipped optional step 3, FailSafe will attempt to migrate all resource groups off that node, but this will fail if there are no other available nodes in the resource group's failover domain. If an error occurs, either complete step 3 or move the resource group to the other node:

If you are using the GUI, run the **Move Resource Group** task, specifying the node you are not patching in the **Failover Domain Node** field.

If you are using `cmgr`, execute the following command:

```
cmgr> admin move resource_group groupname to node nodename
```

5. In a UNIX shell on the node you are upgrading, stop all cluster processes:

```
# /etc/init.d/cluster stop
```

When you are using the GUI, if the **connection lost** dialogue appears, click **No**. If you wish to continue using the GUI, restart the GUI, connecting to a node you are not patching.

6. Verify that the cluster processes (`cad`, `cmond`, `crsd`, and `fs2d`) have stopped:

```
# ps -ef | egrep '(cad|cmond|crsd|fs2d)'
```

7. Use `chkconfig` to turn off the `cluster` flag:

```
# chkconfig cluster off
```

---

**Note:** You cannot use the `failsafe2` flag to turn off the HA services on a node. You must use the GUI or `cmgr` commands to stop HA services; these commands can be run from any node in the pool. If necessary, you can use the force option. For more information, see "Stop FailSafe HA Services" on page 241.

---

8. Install the patch on the node.

9. Use `chkconfig` to turn on the `cluster` flag:

```
# chkconfig cluster on
```

10. Start cluster processes on the node:

```
# /etc/init.d/cluster start
```

11. Start HA services on the node.

If you are using the GUI and you are running the GUI in a Web browser, do the following:

- a. Exit your browser.
- b. Restart the Web server on the node you have just patched.
- c. Restart the GUI, connecting to the patched node.
- d. Run the **Start FailSafe HA Services** task, specifying the node that you just patched in the **One Node Only** field.



If the GUI claims that FailSafe HA services are active on the cluster, then you are using an unpatched client; in this case, run the `cmgr` command instead, run the GUI on a patched client, or run the GUI in a Web browser from the patched node.

If you are using `cmgr`, execute the following command:

```
cmgr> start ha_services on node nodename
```

12. Monitor the resource groups and verify that they come back online on the upgraded node. This may take several minutes, depending on the types and numbers of resources in the groups.

If you are using the GUI, select **View: Groups Owned by Nodes** in the view area. Confirm that the resource group icons indicates online status.

---

**Note:** When you restart HA services on the upgraded node, it can take several minutes for the node and cluster to return to normal `active` state.

---

If you are using `cmgr`, execute the following command:

```
cmgr> show status of resource_group groupname
```

Repeat the above process for the other nodes. If you are using the GUI, remember to reconnect to the node that you have just upgraded. After completing the process for all nodes, you can continue to monitor and administer your upgraded cluster, defining additional new nodes if desired.

## Install Performance Co-Pilot Software

You can deploy Performance Co-Pilot for FailSafe as a collector agent or as a monitor client:

- Collector agents are installed on *collector hosts*, which are the nodes in the FailSafe cluster itself from which you want to gather statistics. Typically, each node in a FailSafe cluster is designated as a collector host.
- A monitor client is installed on the *monitor host*, which is typically a workstation that has a display and is running the IRIS Desktop.

## Installing the Collector Host

To install Performance Co-Pilot for FailSafe on the designated collector hosts, the following software components must already be installed:

- The `pcp_eoe.sw` subsystem from IRIX 6.5.11 or later
- FailSafe 2.1 or later
- Performance Co-Pilot 2.1 or later

A collector license (`PCPCOL`) must also be installed on each of these nodes.

After this software is installed, you must install the following subsystems of Performance Co-Pilot for FailSafe on each collector host. Table 4-2 lists the subsystems required for a collector host and their approximate sizes.

**Table 4-2** Performance Co-Pilot for FailSafe Collector Subsystems

Subsystem	Size in KB
<code>pcp_fsafe.man.pages</code>	40
<code>pcp_fsafe.man.relnotes</code>	32
<code>pcp_fsafe.sw.collector</code>	128

To install the required subsystems on a monitor host, do the following:

1. Mount the FailSafe CD-ROM by inserting it into an available drive. You can access a local CD-ROM drive or a remote CD-ROM drive of another host over the network.
2. Log in as `root`.
3. Start the `inst` command:  

```
# inst
```
4. Specify the installation location:
  - If you are installing from the local CD-ROM drive, enter the following:

```
Inst> from /CDROM/dist
```

- If you are installing from a remote drive, enter the following, where *host* is the name of the host with the CD-ROM drive that contains a mounted FailSafe CD-ROM:

```
Inst> from host:/CDROM/dist
```

5. Select the default subsystems in the `pcp_fsaf` package. The default subsystems are provided for easy installation onto multiple collector hosts:

```
Inst> install default
```

6. Ensure that there are no conflicts:

```
Inst> conflicts
```

7. Install the software:

```
Inst> go
```

8. Change to the `/var/pcp/pmdas/fsaf` directory:

```
# cd /var/pcp/pmdas/fsaf
```

9. Run the `Install` utility, which installs the FailSafe performance metrics into the Performance Co-Pilot performance metrics namespace:

```
# ./Install
```

10. Choose an appropriate configuration for installation of the `fsaf` Performance Metrics Domain Agent (PMDA):

- `collector`, which collects performance statistics on this system
- `monitor`, which allows this system to monitor local and/or remote systems
- `both`, which allows collector and monitor configuration for this system

For example, to choose just the collector, enter the following:

```
Please enter c(ollector) or m(onitor) or b(oth) [b] c
```

## Removing Performance Metrics from a Collector Host

If you wish to remove Performance Co-Pilot for FailSafe from a collector host, you must remove the Performance Co-Pilot for FailSafe metrics from the performance metrics namespace of that host. You can do this before removing the `pcp_fsaf` subsystem by performing the following commands:

1. Change to the `/var/pcp/pmdas/fsafe` directory:

```
# cd /var/pcp/pmdas/fsafe
```

2. Run the Remove utility:

```
# ./Remove
```

### Installing the Monitor Host

To install Performance Co-Pilot for FailSafe on a designated monitor host, the following software components must already be installed on the node:

- The `pcp_eoe.sw` subsystem of IRIX 6.5.11 or later, including the subsystem `pcp_eoe.sw.monitor`
- Performance Co-Pilot 2.1 or later, including the subsystem `pcp.sw.monitor`

The monitor license (PCPMON) must also be installed on the monitor host.

After this software is installed, install the subsystems of Performance Co-Pilot for FailSafe listed in Table 4-3 on each collector host.

**Table 4-3** Performance Co-Pilot for FailSafe Monitor Subsystems

Subsystem	Size in KB
<code>pcp_fsafe.man.pages</code>	40
<code>pcp_fsafe.man.relnotes</code>	32
<code>pcp_fsafe.sw.monitor</code>	516

To install the required subsystems for Performance Co-Pilot for FailSafe on a monitor host, do the following:

1. Mount the Performance Co-Pilot for FailSafe CD-ROM by inserting it into an available drive. You can access a local CD-ROM drive or a remote CD-ROM drive of another host over the network.
2. Log in as root.
3. Start `inst`:

```
# inst
```

4. Specify the installation location:

- If you are installing from the local CD-ROM drive, enter the following:

```
Inst> from /CDROM/dist
```

- If you are installing from a remote drive, enter the following, where *host* is the name of the host with the CD-ROM drive that contains a mounted Performance Co-Pilot for FailSafe CD-ROM:

```
Inst> from host:/CDROM/dist
```

5. Select the required subsystems in the `pcp_fsafe` package for a monitor configuration:

```
Inst> keep pcp_fsafe.sw.collector
Inst> install pcp_fsafe.sw.monitor
```

6. Ensure that there are no conflicts before you install Performance Co-Pilot for FailSafe:

```
Inst> conflicts
```

7. Install the software:

```
Inst> go
```

## Test the System

This section discusses the following ways of testing the system:

- "Private Network Interface" on page 113
- "Serial Reset Connection" on page 114

### Private Network Interface

For each private network on each node in the pool, enter the following, where *nodeIPAddress* is the IP address of the node:

```
# /usr/etc/ping -c 3 nodeIPAddress
```

Typical ping output should appear, such as the following:

```
PING IPaddress (190.x.x.x: 56 data bytes
64 bytes from 190.x.x.x: icmp_seq=0 ttl=254 time=3 ms
64 bytes from 190.x.x.x: icmp_seq=1 ttl=254 time=2 ms
64 bytes from 190.x.x.x: icmp_seq=2 ttl=254 time=2 ms
```

If ping fails, follow these steps:

1. Verify that the network interface was configured up using `ifconfig`; for example:

```
# /usr/etc/ifconfig ec3
ec3: flags=c63<UP,BROADCAST,NOTRAILERS,RUNNING,FILTMULTI,MULTICAST>
inet 190.x.x.x netmask 0xffffffff broadcast 190.x.x.x
```

The UP in the first line of output indicates that the interface was configured up.

2. Verify that the cables are correctly seated.

Repeat this procedure on each node.

### Serial Reset Connection

To test the serial hardware reset connections, do the following:

1. Ensure that the nodes and the serial multiplexer are powered on.
2. Start the `cmgr` command on one of the nodes in the pool:

```
# cmgr
```

3. Stop HA services on each node:

```
stop ha_services for cluster clustername
```

For example:

```
cmgr> stop ha_services for cluster fs6-8
```

Wait until the node has successfully transitioned to inactive state and the FailSafe processes have exited. This process can take a few minutes.

4. Test the serial connections by entering one of the following:

- To test the whole cluster, enter the following:

```
test serial in cluster clustername
```

For example:

```
cmgr> test serial in cluster fs6-8
Status: Testing serial lines ...
Status: Checking serial lines using crsd (cluster reset services) from node fs8
Success: Serial ping command OK.

Status: Checking serial lines using crsd (cluster reset services) from node fs6
Success: Serial ping command OK.

Status: Checking serial lines using crsd (cluster reset services) from node fs7
Success: Serial ping command OK.

Notice: overall exit status:success, tests failed:0, total tests executed:1
```

- To test an individual node, entering the following:

```
test serial in cluster clustername node machinename
```

For example:

```
cmgr> test serial in cluster fs6-8 node fs7
Status: Testing serial lines ...
Status: Checking serial lines using crsd (cluster reset services) from node fs6
Success: Serial ping command OK.

Notice: overall exit status:success, tests failed:0, total tests executed:1
```

- To test an individual node using just a ping, enter the following:

```
admin ping node nodename
```

For example:

```
cmgr> admin ping node fs7

ping operation successful
```

5. If a command fails, make sure all the cables are seated properly and rerun the command.
6. Repeat the process on other nodes in the cluster.

## Modifications Required for Connectivity Diagnostics

If you want to use the connectivity diagnostics provided with FailSafe, ensure that the `.rhosts` file on each administration node allows all the nodes in the cluster to have access to each other in order to run remote commands such as `rsh`. The connectivity tests execute a `ping` command from the local node to all nodes and from all nodes to the local node. To execute `ping` on a remote node, FailSafe uses `rsh` (user `root`). For example, suppose you have a cluster with three nodes: `xfss0`, `fs1`, and `fs2`. The `.rhosts` file on each administration node will be as follows (prompt denotes node name):

```
fs0# cat /.rhosts
fs1 root
fs1-priv root
fs2 root
fs2-priv root
```

```
fs1# cat /.rhosts
fs0 root
fs0-priv root
fs2 root
fs2-priv root
```

```
fs2# cat /.rhosts
fs0 root
fs0-priv root
fs1 root
fs1-priv root
```

Make sure that the mode of the `.rhosts` file is set to 600 (read and write access for the owner only).

After you have completed running the connectivity tests, you may wish to disable `rsh` on all cluster nodes.



## Administration Tools

You can perform FailSafe administration tasks using either the FailSafe Manager graphical user interface (GUI) or the `cmgr` command. Although these tools use the same underlying software command line interface (CLI) to configure and monitor a FailSafe system, the GUI provides the additional features that are particularly important in a production system; see "GUI Features" on page 120.

### FailSafe Manager GUI

The FailSafe Manager GUI lets you configure, administer, and monitor a FailSafe cluster. This section contains the following:

- "Starting the GUI and Connecting to a Node"
- "GUI Features" on page 120
- "Screens" on page 125

### Starting the GUI and Connecting to a Node

There are several methods to start the GUI and connect to a node.

#### Starting the GUI

To start the GUI, use one of the following methods:

- On an IRIX system where the GUI-client software (`sysadm_failsafe2.sw.client`) and desktop support software (`sysadm_failsafe2.sw.desktop`) are installed, do one of the following:

---

**Note:** SGI does not recommend this method across a wide-area network (WAN) or virtual private network (VPN), or if the IRIX system has an R5000 or earlier CPU and less than 128-MB memory.

---

– Enter the following command line:

```
# /usr/sbin/fsmgr
```

(The `fsdetail` and `fstask` commands perform the identical function as `fsmgr`; these command names are kept for historical purposes.)

- Choose the following from the Toolchest:

**System**  
    > **FailSafe Manager**

You must restart the Toolchest after installing FailSafe in order to see the **FailSafe** entry on the Toolchest display. Enter the following commands to restart the Toolchest:

```
# killall toolchest
# /usr/bin/X11/toolchest &
```

If you are using WAN or VPN, see "Starting the GUI on a PC" on page 118.

### Starting the GUI on a PC

To start the GUI on a PC or if you want to perform administration from a remote location via VPN or WAN, do the following:

- Install a web server (such as Apache) and the following packages on one of the FailSafe nodes:

```
sysadm_failsafe2.sw.web
sysadm_xvm.sw.web
```

- Install the Java2 v1.4.1 or v1.3.2 plug-in on your PC.
- Close any existing Java windows and restart the Web browser on the PC.
- Enter the URL `http://server/FailSafeManager/` (where *server* is the name of a FailSafe node in the pool)
- At the resulting webpage, click the FailSafe Manager icon.

---

**Note:** This method can be used on IRIX systems, but it is not the preferred method unless you are using WAN or VPN. If you load the GUI using Netscape on IRIX and then switch to another page in Netscape, the GUI will not operate correctly. To avoid this problem, leave the GUI web page up and open a new Netscape window if you want to view another web page.

---

## Summary of GUI Platforms

Table 5-1 describes the platforms where the GUI may be started, connected to, and displayed.

**Table 5-1** GUI Platforms

GUI Mode	Where You Start the GUI	Where You Connect the GUI	Where the GUI Displays
fsmgr(1) or Toolchest	An IRIX system (such as an SGI 2000 series or SGI O2 workstation) with <code>sysadm_failsafe2.sw.client</code> and <code>sysadm_failsafe2.sw.desktop</code> software installed	The node in the pool that you want to use for cluster administration	The system where the GUI was invoked
Web	Any system with a web browser and Java2 1.4.1 or 1.4.2 plug-in installed and enabled	The FailSafe node in the pool that you want to use for cluster administration	The same system with the web browser

## Logging In

To ensure that the required GUI privileges are available for performing all of the tasks, you should log in to the GUI as `root`. However, some or all privileges can be granted to any other user using the GUI privilege tasks; see . (This functionality is also available with the Privilege Manager, part of the IRIX Interactive Desktop System Administration `sysadmdesktop` product. For more information, see the *Personal System Administration Guide*.)

A dialog box will appear prompting you to log in to a host. You can choose one of the following connection types:

- **Local** runs the server-side process on the local host instead of going over the network
- **Direct** creates a direct socket connection using the `tcpmux` TCP protocol (`tcpmux` must be enabled)

- **Remote Shell** connects to the server via a user-specified command shell, such as `rsh(1C)` or `ssh(1)`. For example:

```
ssh -l root servername
```

---

**Note:** For secure connection, choose **Remote Shell** and type a secure connection command using a utility such as `ssh(1)`. Otherwise, GUI will not encrypt communication and transferred passwords will be visible to users of the network.

---

- **Proxy** connects to the server through a firewall via a proxy server

### Making Changes Safely

Do not make configuration changes on two different administration nodes in the pool simultaneously, or use the GUI, `cmgr(1M)`, and `xvm(1M)` commands simultaneously to make changes. You should run one instance of the `cmgr(1M)` command or the GUI on a single administration node in the pool when making changes at any given time. However, you can use any node in the pool when requesting status or configuration information. Multiple GUI windows accessed via the **File** menu are all part of the same application process; you can make changes from any of these windows.

The node to which you connect the GUI affects your view of the cluster. You should wait for a change to appear in the *view area* before making another change; the change is not guaranteed to be propagated across the cluster until it appears in the view area. (To see the location of the view area, see Figure 5-1 on page 126.) The entire cluster status information is sent to every FailSafe node each time a change is made to the cluster database.

### GUI Features

The FailSafe Manager GUI allows you to administer the entire cluster from a single point. It provides access to the tasks that help you set up and administer your FailSafe cluster:

- *Tasks* let you set up and monitor individual components of a cluster, including XVM volumes. For details about XVM tasks, see the *XVM Volume Manager Administrator's Guide*.
- *Guided configuration tasks* consist of a group of tasks collected together to accomplish a larger goal. For example, **Set Up a New Cluster** steps you through

the process for creating a new cluster and allows you to launch the necessary individual tasks by simply clicking their titles.

This section discusses the following:

- "GUI Window Layout"
- "File Menu" on page 121
- "Edit Menu" on page 122
- "Tasks Menu" on page 122
- "Help Menu" on page 122
- "View Menu" on page 123
- "Performing Tasks" on page 124
- "Getting More Information" on page 125

## GUI Window Layout

By default, the window is divided into two sections: the *view area* and the *details area*. The details area shows generic overview text if no item is selected in the view area. You can use the arrows in the middle of the window to shift the display.

## File Menu

The **File** menu lets you display multiple windows for this instance of the GUI, the `/var/adm/SYSLOG` system log file, and the `/var/sysadm/salog` system administration log file. (The `salog` file shows the commands run directly by this instance of the GUI or run as a side effect of someone running `cmgr` commands on the system or some other instance of the GUI running commands on the system. Changes should not be made simultaneously by multiple instances of the GUI or the GUI and `cmgr`.) The **File** menu also lets you close the current window and exit the GUI completely.

### Edit Menu

The **Edit** menu lets you expand and collapse the contents of the view area. You can choose to automatically expand the display to reflect new nodes added to the pool or cluster. You can also use this menu to select all items in the view menu or clear the current selections.

### Tasks Menu

The **Tasks** menu contains the following:

- **Guided Configuration**, which contains the tasks to set up your cluster, define filesystems, create volumes, check status, and modify an existing cluster
- **Nodes**, which contains tasks to define and manage the nodes
- **Cluster**, which contains tasks to define and manage the cluster
- **Resource Types**, which contains tasks to manage or modify existing resource types, or create new ones
- **Resources**, which contains tasks to set up and configure individual resources
- **Failover Policies**, which contains tasks to determine how FailSafe should keep resource groups highly available
- **Resource Groups**, which contains tasks to define resource groups and manage them
- **FailSafe HA Services**, which allows you to start and stop highly available (HA) services, set the FailSafe tiebreaker node, and set the log configuration
- **Diagnostics**, which contains the tasks to test connectivity, resources, and failover policies
- **Privileges**, which lets you grant or revoke access to a specific task for one or more users
- **Find Tasks**, which lets you use keywords to search for a specific task

### Help Menu

The **Help** menu provides an overview of the GUI and a key to the icons. You can also get help for certain items in blue text by clicking on them.

## View Menu

Choose what you want to view from the **View** menu:

- Resources in groups
- Groups owned by nodes
- Resources owned by nodes
- Resources by type
- Groups by failover policies
- Groups
- Nodes in the cluster
- Nodes in the pool (that is, all defined nodes)
- Users
- Task privileges

### Selecting Items to View or Modify

You can use the following methods to select items:

- Click to select one item at a time
- Shift+click to select a block of items
- Ctrl+click to toggle the selection of any one item

Another way to select one or more items is to type a name into the **Find** text field and then press **Enter** or click the **Find** button.

### Viewing Component Details

To view the details on any component, click its name in the view area; see "Selecting Items to View or Modify" on page 123.

The configuration and status details for the component will appear in the details area to the right. At the bottom of the details area will be the **Applicable Tasks** list, which displays tasks you may wish to launch after evaluating the component's configuration

details. To launch a task, click the task name; based on the component selected, default values will appear in the task window.

To see more information about an item in the details area, select its name (which will appear in blue); details will appear in a new window. Terms with glossary definitions also appear in blue.

### Performing Tasks

To perform an individual task, do the following:

1. Select the task name from the **Task** menu or click the right mouse button within the view area. For example:

**Task**  
    > **Guided Configuration**  
        > **Set Up a New Cluster**

The task window appears.

As a shortcut, you can right-click an item in the view area to bring up a list of tasks applicable to that item; information will also be displayed in the details area.

---

**Note:** You can click any blue text to get more information about that concept or input field.

---

2. Enter information in the appropriate fields and click **OK** to complete the task. (Some tasks consist of more than one page; in these cases, click **Next** to go to the next page, complete the information there, and then click **OK**.)

---

**Note:** In every task, the cluster configuration will not update until you click **OK**.

---

A dialog box appears, confirming the successful completion of the task.

3. Continue launching tasks as needed.



## Getting More Information

Click blue text to see term definitions, instructions on what to input, or item configuration details, or to launch tasks.

In general, clicking on blue text will display one of the following:

- Term definitions
- Input instructions
- Item details
- The selected task window

## Screens

Figure 5-1 shows a sample GUI window.

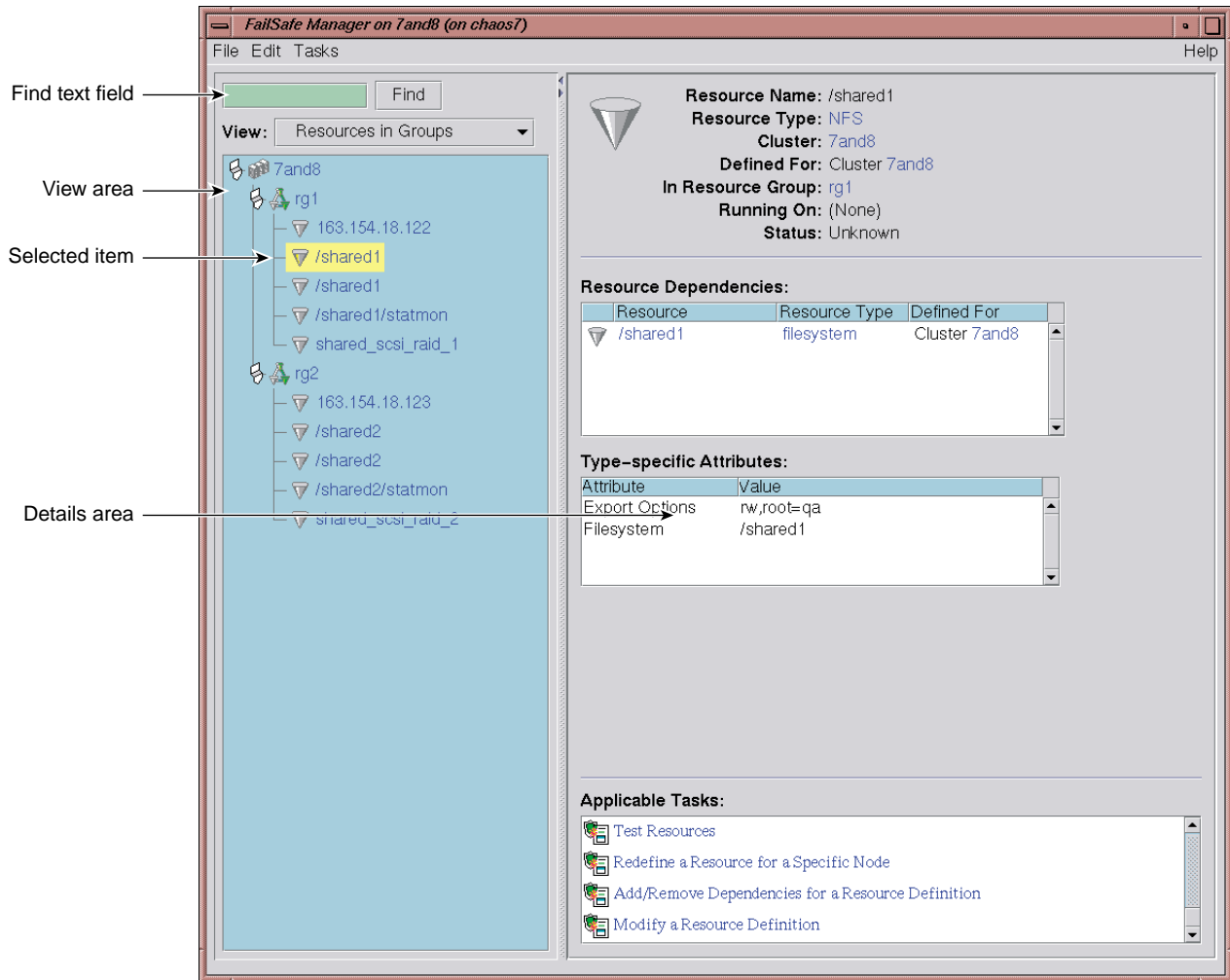

**Figure 5-1** GUI Showing Details for a Resource

Figure 5-2 shows an example of the pop-up menu of applicable tasks that appears when you click the right mouse button on a selected item; in this example, clicking on the resource group name `bartest-group` displays a list of applicable resource-group tasks.

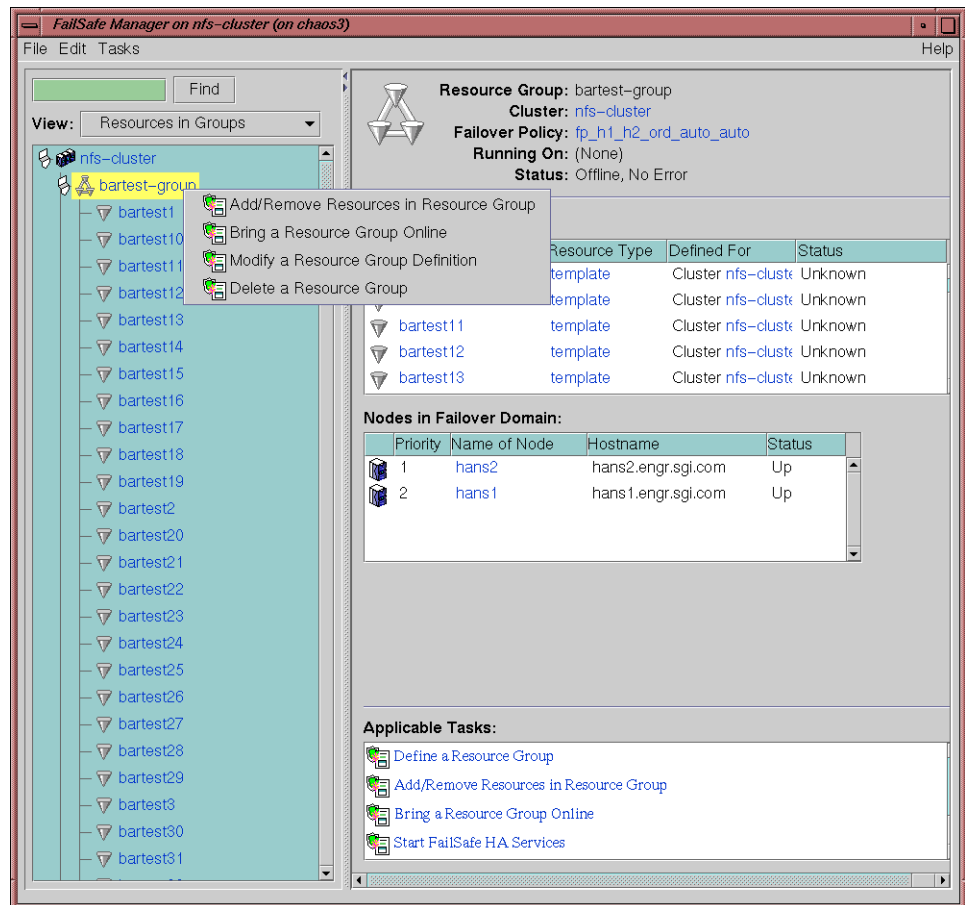

Figure 5-2 Pop-up Menu that Appears After Clicking the Right Mouse Button

## cmgr Command

The `cmgr` command enables you to configure and administer a FailSafe system using a command-line interface on an IRIX system. It provides a minimum of help or formatted output and does not provide dynamic status except when queried. However, an experienced FailSafe administrator may find `cmgr` to be convenient when performing basic FailSafe configuration tasks, executing isolated single tasks in

a production environment, or running scripts to automate some cluster administration tasks.

This section documents how to perform FailSafe administrative tasks by means of the `cmgr` command. You must be logged in as `root`.

The `cmgr` command uses the same underlying FailSafe commands as the GUI.

To use `cmgr`, enter the following:

```
# /usr/cluster/bin/cmgr
```

For more assistance, you can use the `-p` option on the command line; see "Using Prompt Mode" on page 129.

After you have entered this command, you will see the following:

```
Welcome to SGI Cluster Manager Command-Line Interface
cmgr>
```

Once the command prompt displays, you can enter the cluster manager commands.

At any time, you can enter `?` or `help` to bring up the help display.

This section contains the following:

- "Getting Help" on page 129
- "Using Prompt Mode" on page 129
- "Completing Actions and Cancelling" on page 131
- "Command Line Editing within `cmgr`" on page 131
- "Long-Running Tasks" on page 132
- "Startup Script" on page 132
- "Entering Subcommands on the Command Line" on page 133
- "Using Script Files" on page 133
- "Creating a `cmgr` Script Automatically" on page 135
- "Template Scripts" on page 138
- "Invoking a Shell from within `cmgr`" on page 139

## Getting Help

After the command prompt displays, you can enter subcommands. At any time, you can enter `?` or `help` to bring up the `cmgr` help display.

## Using Prompt Mode

The `cmgr` command provides an option which displays detailed prompts for the required inputs that define and modify FailSafe components. You can run in prompt mode in either of the following ways:

- Specify a `-p` option when you enter the `cmgr` command, as in the following example:

```
# cmgr -p
```

- Execute a `set prompting on` command while in normal interactive mode, as in the following example:

```
cmgr> set prompting on
```

This method of entering prompt mode allows you to toggle in and out of prompt mode as you execute individual `cmgr` commands.

To get out of prompt mode, enter the following command:

```
cmgr> set prompting off
```

For example, if you are not in the prompt mode and you enter the following command to define a node, you will see a single prompt, as indicated:

```
cmgr> define node cm1a
```

```
Enter commands, when finished enter either "done" or "cancel"
```

```
cm1a?
```

At the `cm1a?` prompt, enter the individual node definition commands in the following format (for full information on defining nodes, see "Define a Node with `cmgr`" on page 158). For example:

```
cm1a? set hostname to hostname
```

A series of commands is required to define a node. If you are running `cmgr` in prompt mode, however, you are prompted for each required command, as shown in the following example:

```
cmgr> define node cm1a
Enter commands, you may enter "done" or "cancel" at any time to exit

Node Name [cm1a]? cm1a

Hostname[optional]? cm1a
Is this a FailSafe node <true|false> ? true
Is this a CXFS node <true|false> ? false
Node ID ? 1
Partition ID[optional] ? (0)
Reset type <powerCycle|reset|nmi> ? (powerCycle)
Do you wish to define system controller info[y/n]:y
Sysctrl Type <msc|mmsc|l2|l1>? (msc) msc
Sysctrl Password [optional]? ( )
Sysctrl Status <enabled|disabled>? enabled
Sysctrl Owner? cm2
Sysctrl Device? /dev/ttyd2
Sysctrl Owner Type <tty> [tty]?
Number of Network interfaces [2]? 2
NIC 1 - IP Address? cm1
NIC 1 - Heartbeat HB (use network for heartbeats) <true|false>? true
NIC 1 - (use network for control messages) <true|false>? true
NIC 1 - Priority <1,2,...>? 1
NIC 2 - IP Address? cm2
NIC 2 Heartbeat HB (use network for heartbeats) <true|false>? true
NIC 2 - (use network for control messages) <true|false>? false
NIC 2 - Priority <1,2,...>? 2
```

## Completing Actions and Cancelling

When you are creating or modifying a component of a cluster, you can enter either of the following commands:

- `cancel`, which aborts the current mode and discards any changes you have made
- `done`, which commits the current definitions or modifications and returns to the `cmgr>` prompt

## Command Line Editing within `cmgr`

The `cmgr` command supports the following command-line editing commands:

<code>history [n]</code> or <code>h [n]</code>	Displays command line history. The optional <i>n</i> can be used to set the number commands that will be remembered.
<code>!!</code>	Refers to the previous command. By itself, this substitution repeats the previous command.
<code>!n</code>	Refers to command line <i>n</i> .
<code>!-n</code>	Refers to the current command line minus <i>n</i> .
<code>!string</code>	Refers to the most recent command starting with <i>string</i> .
<code>exit</code>	Exits from the shell.
<code>Ctrl-W</code>	Deletes the previous word.
<code>Ctrl-D</code>	Deletes the current character.
<code>Ctrl-A</code>	Goes to the beginning of the line.
<code>Ctrl-E</code>	Goes to the end of the line.
<code>Ctrl-F</code>	Moves forward one character.
<code>Ctrl-B</code>	Moves backward one character.
<code>Ctrl-H</code>	Deletes the previous character.
<code>Ctrl-N</code>	Moves down in the history.
<code>Ctrl-K</code>	Erases to the end of the line from the cursor.
<code>Ctrl-L</code>	Clears the screen and redisplay the prompt.
<code>Ctrl-P</code>	Moves up in the history.
<code>Ctrl-U</code>	Erases to the beginning of line from the cursor.

Ctrl-R	Redraws the input line.
Esc-f	Moves forward one word.
Esc-b	Moves backward one word.
Esc-d	Deletes the next word.
Esc-DEL	Deletes the previous word.

## Long-Running Tasks

The tasks to define the cluster and to stop HA services are long-running tasks that might take a few minutes to complete. The `cmgr` command will provide intermediate task status for such tasks. For example:

```
cmgr> stop ha_services in cluster nfs-cluster
Making resource groups offline
Stopping HA services on node node1
Stopping HA services on node node2
```

## Startup Script

You can set the environment variable `CMGR_STARTUP_FILE` to point to a startup `cmgr` script. The startup script that this variable specifies is executed when `cmgr` is started (with or without the `-p` option). Only the `set` and `show` commands of the `cmgr` are allowed in the `cmgr` startup file.

The following is an example of a `cmgr` startup script file called `cmgr_rc`:

```
set cluster test-cluster
show status of resource_group oracle_rg
```

To specify this file as the startup script, execute the following command:

```
# setenv CMGR_STARTUP_FILE /cmgr_rc
```

Whenever `cmgr` is started, the `cmgr_rc` script is executed. The default cluster is set to `test-cluster` and the status of resource group `oracle_rg` in cluster `test-cluster` is displayed.



## Entering Subcommands on the Command Line

You can enter some `cmgr` subcommands directly from the command line using the following format:

```
cmgr -c "subcommand"
```

where *subcommand* can be any of the following with the appropriate operands:

- `admin`, which allows you to perform certain actions such as resetting a node
- `delete`, which deletes a cluster or a node
- `help`, which displays help information
- `show`, which displays information about the cluster or nodes
- `start`, which starts HA services and sets the configuration so that HA services will be automatically restarted upon reboot
- `stop`, which stops HA services and sets the configuration so that HA services are not restarted upon reboot
- `test`, which tests connectivity

For example, to display information about the cluster, enter the following:

```
# cmgr -c "show clusters"
1 Cluster(s) defined
   eagan
```

See Chapter 6, "Configuration" on page 141, and the `cmgr` man page for more information.

## Using Script Files

You can execute a series of `cmgr` commands by using the `-f` option and specifying an input file, as follows:

```
cmgr -f input_file
```

Or you could include the following as the first line of the file and then execute it as a script:

```
#!/usr/cluster/bin/cmgr -f
```

Each line of the file must be a valid `cmgr` command line, comment line (starting with `#`), or a blank line. (You must include a `done` command line to finish a multilevel command and end the file with a `quit` command line.)

If any line of the input file fails, `cmgr` will exit. You can choose to ignore the failure and continue the process by using the `-i` option with the `-f` option, as follows:

```
cmgr -if input_file
```

Or include it in the first line for a script:

```
#!/usr/cluster/bin/cmgr -if
```

---

**Note:** If you include `-i` when using a `cmgr` command line as the first line of the script, you must use this exact syntax (that is, `-if`).

---

For example, suppose the file `/tmp/showme` contains the following:

```
fs6# more /tmp/showme
show clusters
show nodes in cluster fs6-8
quit
```

You can execute the following command, which will yield the indicated output:

```
fs6# /usr/cluster/bin/cmgr -if /tmp/showme
```

```
1 Cluster(s) defined
    fs6-8
```

```
Cluster fs6-8 has following 3 machine(s)
    fs6
    fs7
    fs8
```

Or you could include the `cmgr` command line as the first line of the script, give it execute permission, and execute `showme` itself:

```
fs6# more /tmp/showme
#!/usr/cluster/bin/cmgr -if
#
show clusters
show nodes in cluster fs6-8
quit
```

```
fs6# /tmp/showme
```

```
1 Cluster(s) defined
    fs6-8
```

```
Cluster fs6-8 has following 3 machine(s)
```

```
    fs6
    fs7
    fs8
```

## Creating a `cmgr` Script Automatically

After you have configured the cluster database, you can use the `build_cmgr_script` command to automatically create a `cmgr` script based on the contents of the cluster database. The generated script will contain the following:

- Node definitions
- Cluster definition
- Resource definitions
- Resource type definitions
- Resource group definitions
- Failover policy definitions
- HA parameters settings

- Any changes made using either the `cmgr` command or the GUI
- CXFS information (only in a coexecution cluster)

When you use the `-s` option, the command also generates `create_resource_type` scripts for resource types.

As needed, you can then use the generated script to recreate the cluster database after performing a `cdbreinit`.

By default, the generated script is placed in the following location:

```
/var/cluster/ha/tmp/cmgr_create_cluster_clusername_processID
```

You can specify an alternative path name by using the `-o` option:

```
build_cmgr_script [-o script_pathname]
```

For more details, see the `build_cmgr_script` man page.

For example:

```
# /var/cluster/cmgr-scripts/build_cmgr_script -o /tmp/newcdb
Building cmgr script for cluster test-cluster ...
build_cmgr_script: Generated cmgr script is /tmp/newcdb
```

The example script file contents are as follows:

```
#!/usr/cluster/bin/cmgr -f

# Node node1 definition
define node node1
    set hostname to node1.dept.company.com
    set is_failsafe to true
    set nodeid to 32065
    set hierarchy to Reset,Shutdown
    set reset_type to powerCycle
    set sysctrl_type to msc
    set sysctrl_status to enabled
    set sysctrl_owner to node2
    set sysctrl_device to /dev/ttyd2
    set sysctrl_owner_type to tty
    add nic 192.0.2.58
```

```
        set heartbeat to true
        set ctrl_msgs to true
        set priority to 1
    done
    add nic 160.0.2.15
        set heartbeat to true
        set ctrl_msgs to true
        set priority to 2
    done
done

# Node node2 definition
define node node2
    set hostname to node2.dept.company.com
    set is_failsafe to true
    set nodeid to 24140
    set hierarchy to Reset,Shutdown
    set reset_type to powerCycle
    set sysctrl_type to msc
    set sysctrl_status to enabled
    set sysctrl_owner to node1
    set sysctrl_device to /dev/ttyd2
    set sysctrl_owner_type to tty
    add nic 192.0.2.59
        set heartbeat to true
        set ctrl_msgs to true
        set priority to 1
    done
    add nic 160.0.2.16
        set heartbeat to true
        set ctrl_msgs to true
        set priority to 2
    done
done

# Define cluster and add nodes to the cluster
define cluster test-cluster
    set is_failsafe to true
    set ha_mode to normal
done
```

```
modify cluster test-cluster
    add node node1
    add node node2
done

set cluster test-cluster

quit
```

## Template Scripts

Template files of scripts that you can modify to configure the different components of your system are located in the `/var/cluster/cmgr-templates` directory.

Each template file contains a list of `cmgr` commands to create a particular object, as well as comments describing each field. The template also provides default values for optional fields.

Table 5-2 shows the template scripts for `cmgr` that are found in the `/var/cluster/cmgr-templates` directory.

**Table 5-2** Template Scripts for `cmgr`

File name	Description
<code>cmgr-create-cluster</code>	Creates a cluster
<code>cmgr-create-failover_policy</code>	Creates a failover policy
<code>cmgr-create-node</code>	Creates a node
<code>cmgr-create-resource_group</code>	Creates a resource group
<code>cmgr-create-resource_type</code>	Creates a resource type
<code>cmgr-create-resource-ResourceType</code>	Creates a the specified resource of type

To create a FailSafe configuration, you can concatenate multiple templates into one file and execute the resulting script. If you concatenate information from multiple template scripts to prepare your cluster configuration, you must remove the `quit` at the end of each template script, except for the final `quit`. A `cmgr` script must have only one `quit` line.

For example, for a three-node configuration with an NFS resource group containing one volume, one filesystem, one IP\_address, and one NFS resource, you would concatenate the following files, removing the quit at the end of each template script except the last one:

- Three copies of the `cmgr-create-node` file
- One copy of each of the following files:

```
cmgr-create-cluster  
cmgr-create-failover_policy  
cmgr-create-resource_group  
cmgr-create-resource-volume  
cmgr-create-resource-filesystem  
cmgr-create-resource-IP_address  
cmgr-create-resource-NFS
```

### Invoking a Shell from within `cmgr`

Enter the following command to invoke a shell from within `cmgr`:

```
cmgr> sh
```

To exit the shell and to return to the `cmgr` prompt, enter `exit` at the shell prompt.





## Configuration

This chapter provides a summary of the steps required to configure a cluster using either the FailSafe Manager graphical user interface (GUI) or the `cmgr` command.

---

**Note:** For the initial installation, SGI **highly** recommends that you use the GUI guided configuration tasks. See "Guided Configuration with the GUI" on page 146.

SGI also recommendeds that you perform all FailSafe administration from one node in the pool so that the latest copy of the database will be available even when there are network partitions.

---

The following sections describe the preliminary steps you should follow, information you must understand, the GUI guided configuration, and the various individual tasks using the GUI and `cmgr`.

### Preliminary Steps

The cluster processes are started automatically when FailSafe and cluster subsystems from the IRIX CD are installed. Complete the following steps to ensure that you are ready to configure the initial cluster:

- "Verify that the Cluster `chkconfig` Flag is On" on page 142
- "Start the Cluster Daemons" on page 142
- "Verify that the Cluster Daemons are Running" on page 142
- "Determine the Hostname of the Node" on page 143

During the course of configuration, you will see various information-only messages in the log files.

### Verify that the Cluster `chkconfig` Flag is On

Ensure that the output from `chkconfig` shows the following flag set to on:

```
# chkconfig
   Flag                State
   ====                =====
   cluster             on
```

If it is not, set it to on. For example:

```
# chkconfig cluster on
```

### Start the Cluster Daemons

Enter the following to start the cluster daemons:

```
# chkconfig cluster on
# /etc/init.d/cluster start
```

After you start highly available (HA) services, the following daemons are also started on a base FailSafe system (without optional plug-ins):

- `ha_fsd`
- `ha_cmsd`
- `ha_gcd`
- `ha_srmd`
- `ha_ifd`

### Verify that the Cluster Daemons are Running

When you **first install** the software, the following cluster daemons should be running:

- `fs2d`
- `cmond`
- `cad`
- `crsd`

To determine which daemons are running, enter the following:

```
ps -ef | grep cluster
```

The following shows an example of the output when just the initial daemons are running; for readability, whitespace has been removed and the daemon names are highlighted:

```
# ps -ef | grep cluster
root 31431      1 0 12:51:36 ?      0:14 /usr/lib32/cluster/cbe/fs2d /var/cluster/cdb/cdb.db #
root 31456 31478 0 12:53:01 ?      0:03 /usr/cluster/bin/crsd -l
root 31475 31478 0 12:53:00 ?      0:08 /usr/cluster/bin/cad -l -lf /var/cluster/ha/log/cad_log --append_log
root 31478      1 0 12:53:00 ?      0:00 /usr/cluster/bin/cmond -L info -f /var/cluster/ha/log/cmnd_log
root 31570 31408 0 14:01:52 pts/0 0:00 grep cluster
```

If you do not see these processes, go to the logs to see what the problem might be. If you must restart the daemons, enter the following:

```
# /etc/init.d/cluster restart
```

## Determine the Hostname of the Node

When you are initially configuring the cluster, you must use the IP address or the value of `/etc/sys_id` when logging in to the GUI and when defining the nodes in the pool. The value of `/etc/sys_id` must match the name of the IP address for the node in `/etc/hosts`. The value of `/etc/sys_id` is displayed by the `hostname` command. For example:

```
# hostname
fs6
```

Also, if you use `nsd`, you must configure your system so that local files are accessed before the network information service (NIS) or the domain name service (DNS). See "System File Configuration" on page 69.



---

**Caution:** It is critical that these files are configured properly and that you enter the hostname for the nodes. See "Install FailSafe" on page 87.

---

## Name Restrictions

When you specify the names of the various components of a FailSafe system, the name cannot begin with an underscore (`_`) or include any whitespace characters. In addition, the name of any FailSafe component cannot contain a space, an unprintable character, or a `*`, `?`, `\`, or `#`.

The following is the list of permitted characters for the name of a FailSafe component:

- alphanumeric characters
- `/`
- `.`
- `-` (hyphen)
- `_` (underscore)
- `:`
- `"`
- `=`
- `@`
- `'`

These character restrictions apply whether you are configuring your system with the GUI or `cmgr`.

## Configuring Timeout Values and Monitoring Intervals

When you configure the components of a FailSafe system, you configure various timeout values and monitoring intervals that determine the application downtime of a highly available (HA) system when there is a failure. To determine reasonable values to set for your system, consider the following equations:

$$\text{application\_downtime} = \text{failure\_detection} + \text{time\_to\_handle\_failure} + \text{failure\_recovery\_time}$$

Failure detection depends on the type of failure that is detected:

- When a node goes down, there will be a node failure detection after the node timeout time, which is one of the parameters that you can modify. All failures that

translate into a node failure (such as heartbeat failure and operating system failure) fall into this failure category. Node timeout has a default value of 15 seconds.

- When there is a resource failure, there will be a monitor failure of a resource. The time this will take is determined by the following:
  - The monitoring interval for the resource type
  - The monitor timeout for the resource type
  - The number of restarts defined for the resource type, if the restart mode is configured on

For information on setting values for a resource type, see "Define a Resource Type with the GUI" on page 185.

Reducing these values will result in a shorter failover time, but could also lead to significant increase in the FailSafe overhead, which will affect the system performance and could lead to false failovers.

The time to handle a failure is something that the user cannot control. In general, this should take a few seconds.

The failure recovery time is determined by the total time it takes for FailSafe to perform the following:

- Execute the failover policy script (approximately 5 seconds).
- Run the `stop` action script for all resources in the resource group. This is not required for node failure; the failing node will be reset.
- Run the `start` action script for all resources in the resource group.

## Setting Configuration Defaults with `cmgr`

Certain `cmgr` commands require you to specify a cluster, node, or resource type. Before you configure the components of a FailSafe system, you can set defaults for these values that will be used if you do not specify an explicit value. The default values are in effect only for the current session of `cmgr`.

Use the following `cmgr` commands:

- Default cluster:

```
set cluster Clustername
```

For example:

```
cmgr> set cluster test-cluster
```

- Default node:

```
set node Nodename
```

For example:

```
cmgr> set node node1
```

- Default resource type:

```
set resource_type RTname
```

For example:

```
cmgr> set resource_type IP_address
```

To view the current default configuration values, use the following command:

```
show set defaults
```

## Guided Configuration with the GUI

The GUI provides guided configuration task sets to help you configure your FailSafe cluster.

The node from which you run the GUI affects your view of the cluster. You should wait for a change to appear in the view area before making another change; the change is not guaranteed to be propagated across the cluster until the icons appear in the view area.

You should only make changes from one instance of the GUI running at any given time; changes made by a second GUI instance (a second invocation of `fsmgr`) may overwrite changes made by the first instance. However, multiple windows accessed

via the **File** menu are all part of a single GUI instance; you can make changes from any of these windows.

## Set Up a New Cluster

---

**Note:** Within the tasks, you can click on any **blue** text to get more information about that concept or input field. In every task, the cluster configuration will not update until you click **OK**.

---

The **Set Up a New Cluster** task in the **Guided Configuration** leads you through the steps required to create a new cluster. It encompasses tasks that are detailed elsewhere.

The GUI provides a convenient display of a cluster and its components. Verify your progress to avoid adding nodes too quickly.

Do the following:

1. Click **Define a Node** to define the node to which you are connected (that is, the local node). The hostname that appears in `/etc/sys_id` is used for all node definitions. See "Define a Node" on page 154.
- 

**Note:** If you attempt to define a cluster or other object before the local node has been defined, you will get an error message that says:

```
No nodes are registered on servername. You cannot define a cluster until you define the node to which the GUI is connected. To do so, click "Continue" to launch the "Set Up a New Cluster" task.
```

---

2. (Optional) **After** the first node icon appears in the view area, click on step 2, **Define a Node**, to define the other nodes in the cluster. The hostname/IP-address pairings and priorities of the networks must be the same for each node in the cluster.
- 

**Note:** Do not define a second node until the icon for the first node appears in the view area. If you add nodes too quickly (before the database can include the node), errors will occur.

---

Repeat this step for each node. For large clusters, SGI recommends that you define only the first three nodes and then continue on to the next step; add the remaining nodes after you have a successful small cluster.

3. Click **Define a Cluster** to create the cluster definition. See "Define a Cluster" on page 175. Verify that the cluster appears in the view area; choose **View: Nodes in Cluster**.
4. Click **Add/Remove Nodes in Cluster** to add the nodes to the new cluster. See "Add or Remove Nodes in the Cluster with the GUI" on page 164.

Click **Next** to move to the second page of tasks.

5. (*Optional*) Click **Test Connectivity** to verify that the nodes are physically connected. See "Test Connectivity with the GUI" on page 337. (This test requires the proper configuration of the `/etc/.rhosts` file.)
6. Click **Start HA Services**.
7. Click **Close**. Clicking on **Close** exits the task; it does not undo the task.

## Set Up a Highly Available Resource Group

---

**Note:** Within the tasks, you can click on any blue text to get more information about that concept or input field. In every task, the cluster configuration will not update until you click **OK**.

---

The **Set Up a Highly Available Resource Group** task leads you through the steps required to define a resource group. It encompasses tasks that are detailed elsewhere.

Do the following:

1. Define a new resource. See "Define a Resource" on page 208.
2. Add any required resource dependencies. See "Add/Remove Dependencies for a Resource Definition" on page 217.
3. Verify the resources and dependencies. See "Test Resources with the GUI" on page 338.
4. Define a failover policy to specify where the resources can run. See "Define a Failover Policy" on page 223.



5. Test the failover policies. See "Test Failover Policies with the GUI" on page 338.  
Click **Next** to move to the next page.
6. Define a resource group that uses the failover policy you defined earlier. See "Define a Resource Group" on page 234.
7. Add or remove resources in resource group. See "Test Failover Policies with the GUI" on page 338.
8. Set the resources in the resource group to start when HA services are started. See "Bring a Resource Group Online" on page 315.
9. Start FailSafe HA services if they have not already been started. See "Start FailSafe HA Services with the GUI" on page 240.

Repeat these steps for each resource group.

## Set Up an Existing CXFS Cluster for FailSafe

This task appears on the GUI if you also have CXFS installed.

---

**Note:** Within the tasks, you can click on any blue text to get more information about that concept or input field. In every task, the cluster configuration will not update until you click **OK**.

---

The **Set Up an Existing CXFS Cluster for FailSafe** task leads you through the steps required to convert existing CXFS nodes and the cluster to FailSafe. It encompasses tasks that are detailed elsewhere.

There is a single database for FailSafe and CXFS. If a given node applies to both products, ensure that any modifications you make are appropriate for both products.

Do the following:

1. Click **Convert a CXFS Cluster to FailSafe**. This will change the cluster type to CXFS and FailSafe. See "Convert a CXFS Cluster to FailSafe with the GUI" on page 181.
2. Use the CXFS GUI (or `cmgr` command) to stop CXFS services on the nodes to be converted. See the *CXFS Administration Guide for SGI InfiniteStorage*.

3. Click **Convert a CXFS Node to FailSafe** to convert the local node (the node to which you are connected). A converted node can be of type CXFS and FailSafe or FailSafe. See "Convert a CXFS Node to FailSafe with the GUI" on page 169.
4. Click **Convert a CXFS Node to FailSafe** to convert another node. Repeat this step for each node you want to convert.
5. Click **Start HA Services**.

## Fix or Upgrade Cluster Nodes

You can use the following tasks to fix or upgrade nodes:

- Migrate all resource groups off the node. This might require using the **Force** option. See "Move a Resource Group with the GUI" on page 319.
- Stop FailSafe HA services on the cluster nodes. See "Stop FailSafe HA Services" on page 241.
- Perform the necessary maintenance on the node. Only if required, see "Reset a Node with the GUI" on page 322.
- Turn HA services back on so that the node and its resource groups are monitored. See "Start FailSafe HA Services with the GUI" on page 240.
- Monitor the state of the cluster components in the view area. See "System Status" on page 297.

## Make Changes to Existing Cluster

You can make most cluster changes when HA services are active. To use the destructive option in FailSafe diagnostics, you must stop HA services on all nodes in the cluster. To make changes to network configuration (IP address, hostname, network interfaces) in a FailSafe node, you must stop HA and cluster services on all nodes in the pool.

See the following:

- "Modify a Cluster Definition" on page 179
- "Define a Node" on page 154

- "Test Connectivity with the GUI" on page 337
- "Add or Remove Nodes in the Cluster with the GUI" on page 164
- "Set FailSafe HA Parameters" on page 244

## Optimize Node Usage

You can improve cluster performance by taking advantage of a particular node's hardware. For example, one node in the cluster may have a larger disk or a faster CPU.

Depending upon your situation, you may find the following tasks useful:

- Ensure that a resource group will always run on the more powerful node; list that node first in the failover domain and choose `Automatic` as the recover attribute. See "Modify a Failover Policy Definition with the GUI" on page 229.
- "Move a Resource Group with the GUI" on page 319.
- Create a resource that has a custom definition on a specific node. See "Redefine a Resource for a Specific Node" on page 216.
- Create a resource type that is defined only for the chosen node (as opposed to the entire cluster). See "Redefine a Resource Type for a Specific Node" on page 194.

## Define Custom Resource

You can use the following tasks to define a custom resource:

- "Define a Resource Type" on page 185
- "Redefine a Resource for a Specific Node" on page 216
- "Add/Remove Dependencies for a Resource Type" on page 198
- "Define a Resource" on page 208
- "Add/Remove Dependencies for a Resource Definition" on page 217
- "Test Resources with the GUI" on page 338

## Customize FailSafe Failure Detection

You can do the following to customize how FailSafe monitors and fails over resource groups:

- Change the node timeout or the heartbeat period (the time interval at which FailSafe sends messages between nodes). See "Set FailSafe HA Parameters" on page 244.
- Change the monitor action timeout and the restart action timeout used by a resource type. See "Modify a Resource Type Definition" on page 201.

## Customize Resource Group Failover Behavior

You can use various tasks to change failover behavior in the cluster or the resource group:

- To change how the cluster detects when a failover is necessary, see "Set FailSafe HA Parameters" on page 244.
- To change the nodes and their ordering in the failover domain, see "Modify a Failover Policy Definition" on page 229.
- To change monitoring settings for the resource types used in the resource group, see "Modify a Resource Type Definition" on page 201.

You can also create a custom failover policy script:

1. Use the *FailSafe Programmer's Guide for SGI Infinite Storage* to write a custom failover script.
2. Place the scripts in the `/var/cluster/ha/policies` directory.
3. Restart the FailSafe Manager GUI.
4. Change the desired failover policy to use your new custom failover script. See "Modify a Failover Policy Definition" on page 229.
5. Select **View: Groups owned by Nodes** in the GUI view area.
6. Test the script by moving a resource group from one node to another, simulating failover. Watch the resource group behavior in the view area to confirm that failover behavior works as expected. See "Move a Resource Group with the GUI" on page 319.

## Customize Resource Failover Behavior

You can customize resource failover behavior by editing existing action scripts or creating new scripts. Do the following:

1. Make a copy of the action scripts you want to modify. Action scripts for each resource type are contained in the `/var/cluster/ha/resource_types` directory.
2. Edit the copies or create new scripts. See the *FailSafe Programmer's Guide for SGI Infinite Storage*.
3. Place the edited/new scripts in the appropriate subdirectory in `/var/cluster/ha/resource_types`.
4. Restart the FailSafe Manager GUI.
5. Make use of the new scripts in the resource type. See "Define a Resource Type" on page 185, and "Modify a Resource Type Definition" on page 201.
6. Define resources using the new resource type. See "Define a Resource" on page 208.
7. Verify that FailSafe can manage the new custom resources. See "Test Resources with the GUI" on page 338.
8. Add the new resource. See "Add or Remove Nodes in the Cluster" on page 164.

## Redistribute Resource Load in Cluster

After setting up resource groups and observing how they fail over, you may want to distribute the resource groups differently to balance the load among the nodes in the cluster. Do the following:

1. Determine the current load. For example, invoke the **System Manager** tool from the Toolchest, then launch the graphical system monitor window by selecting the **System Performance** category and then the **View System Resources** task to view various system load statistics. For more information, see the `gr_osview` man page.
2. If you want to redistribute the resource groups among the nodes, see "Move a Resource Group with the GUI" on page 319.

3. If you want to create a new failover policy that uses nodes in a different order or uses different nodes, do the following:
  - Create a new failover policy to use nodes more efficiently. See "Define a Failover Policy" on page 223.
  - Use the new failover policy for the resource group. See "Modify a Resource Group Definition" on page 236.
  - Move the resource group to activate the new failover policy. (FailSafe will only start using a failover policy when the associated resource group is moved.) See "Move a Resource Group with the GUI" on page 319.

## Node Tasks

A *node* is an operating system (OS) image, usually an individual computer. A node can belong to only one cluster.

This use of the term *node* does not have the same meaning as a node in an SGI Origin 3000 or SGI 2000 system.

This section describes the following node configuration tasks:

- "Define a Node"
- "Add or Remove Nodes in the Cluster" on page 164
- "Modify a Node Definition" on page 164
- "Convert a CXFS Node to FailSafe" on page 169
- "Delete a Node" on page 171
- "Display a Node" on page 173

## Define a Node

This section describes how to define a node.

### Define a Node with the GUI

The first node you define must be the node that you have logged into, in order to perform cluster administration.

---

**Note:** Within the tasks, you can click on any blue text to get more information about that concept or input field. In every task, the cluster configuration will not update until you click **OK**.

---

To define a node, do the following:

1. Enter the following:

- **Hostname:** Hostname of the node you are defining, such as `mynode.company.com` (this can be abbreviated to `mynode` if it is resolved on all nodes).

---

**Note:** If you attempt to define a cluster or other object before the local node has been defined, you will get an error message that says:

No nodes are registered on *servername*. You cannot define a cluster until you define the node to which the GUI is connected. To do so, click "Continue" to launch the "Set Up a New Cluster" task.

---

- **Logical Name:** The same as the hostname, or an abbreviation of the hostname (such as `lilly`), or an entirely different name (such as `nodeA`). Logical names cannot begin with an underscore (`_`) or include any whitespace characters, and can be at most 255 characters.

---

**Note:** If you want to rename a node, you must delete it and then define a new node.

---

- **Networks for Incoming Cluster Messages:** Do the following:
  - **Network:** Enter the IP address or hostname of the private network. (The hostname must be resolved in the `/etc/hosts` file.) The priorities of the networks must be the same for each node in the cluster. For information about using the hostname, see "System File Configuration" on page 69. For information about why a private network is required, see "Private Network" on page 9.
  - **Messages to Accept:** Select the appropriate type. You can use the **None** setting if you want to temporarily define a network but do not want it to accept messages.

- Click **Add** to add the network to the list.

If you later want to modify the network, click the network in the list to select it, then click **Modify**.

If you want to delete a network from the list, click the network in the list to select it, then click **Delete**.

- **Node ID:** (*Optional*) An integer in the range 1 through 32767 that is unique among the nodes in the pool. If you do not specify a number, FailSafe will calculate an ID for you. The default ID is a 5-digit number based on the machine's serial number and other machine-specific information; it is not sequential.



**Caution:** You must not change the node ID number after the node has been defined.

---

- **Partition ID:** (*Optional*) Uniquely defines a partition in a partitioned SGI Origin 3000 system. If your system is not partitioned, leave this field empty.
- 

**Note:** Use the `mkpart` command to determine the partition ID value:

- The `-n` option lists the partition ID (which is 0 if the system is not partitioned).
- The `-l` option lists the bricks in the various partitions (use `rack#.slot#` format in the GUI)

For example (output truncated here for readability):

```
# mkpart -n
Partition id = 1
# mkpart -l
partition: 3 = brick: 003c10 003c13 003c16 ...
partition: 1 = brick: 001c10 001c13 001c16 ...
```

You could enter one of the following for the **Partition ID** field:

```
1
001.10
```

---

Click **Next** to move to the next page.



- You can choose whether or not to use the system controller port to reset the node. If you want FailSafe to be able to use the system controller to reset the node, you select the **Set Reset Parameters** checkbox and provide the following information:
  - This node:
    - **Port Type:** select **L1** (L1 system controller for Origin 300, Origin 3200C, Onyx 300, and Onyx 3200C systems), **L2** (L2 system controller for Origin 3400, Origin 3800, Origin 300 with NUMAlink module, and Onyx 3000 series), **MSC** (module system controller for Origin 200, Onyx2 deskside, and SGI 2100, 2200 deskside systems ), or **MMSC** (multimodule system controller for rackmount SGI 2400, SGI 2800 and Onyx2 systems).
    - **Reset Method:** The type of reset to be performed: power cycle, serial reset, or NMI (nonmaskable interrupt)
    - **Port Password:** system controller password for privileged commands, **not** the node's `root` password or PROM password. On some machines, the system administrator may not have set this password. If you wish to set or change the system controller port password, consult the hardware manual for your node.
    - **Temporarily Disable Port:** if you want to provide reset information now but do not want to allow the reset capability at this time, check this box. If this box is checked, FailSafe cannot reset the node.
  - Owner (node that sends reset command):
    - **Logical Name:** name of the node that sends the remote reset command. Serial cables must physically connect the node being defined and the owner node through the system controller port. At run time, the node must be defined in the pool.

You can select a logical name or enter the logical name of a node that is not yet defined. However, you must define the node before you run the node connectivity diagnostics task.
    - **TTY Device:** name of the terminal port (TTY) on the owner node to which the system controller is connected, such as `/dev/ttyd2`. The other end of the cable connects to this node's system controller port, so the node can be controlled remotely by the other node.

If you do not want to use the reset function at all, click the **Set System Controller Parameters** box to deselect (uncheck) it.

2. Click **OK** to complete the task.

You can use the hostname or the IP address as input to the network interface field. However, using the hostname requires DNS on the nodes; therefore, you may want to use the actual IP address.

---

**Note:** Do not add a second node until the first node icon appears in the view area. The entire cluster status information is sent each time a change is made to the cluster database; therefore, the larger the configuration, the longer it will take.

---

### Define a Node with `cmgr`

To define a node, use the following commands:

```
define node LogicalHostname
  set hostname to Hostname
  set nodeid to NodeID
  set node_function to server_admin|client_admin
  set partition_id to PartitionID
  set reset_type to powerCycle|reset|nmi
  set sysctrl_type to mssc|mmsc|I2|I1 (based on node hardware)
  set sysctrl_password to Password
  set sysctrl_status to enabled|disabled
  set sysctrl_owner to Node_sending_reset_command
  set sysctrl_device to /dev/ttyd2
  set sysctrl_owner_type to tty_device
  set is_failsafe to true|false
  set is_cxfs to true|false
  add nic IPaddressOrHostname (if DNS)
    set heartbeat to true|false
    set ctrl_msgs to true|false
    set priority to integer
  remove nic IPaddressOrHostname (if DNS)
```

There are additional commands that apply to CXFS; if you are running a coexecution cluster, see *CXFS Administration Guide for SGI InfiniteStorage* for more information.

## Usage notes:

- `node` is the same as the hostname (such as `mynode.company.com`), or an abbreviation of the hostname (such as `mynode`), or an entirely different name (such as `nodeA`). Logical names cannot begin with an underscore (`_`) or include any whitespace characters, and can be at most 255 characters.
- `hostname` is the hostname as returned by the `hostname` command on the node being defined. Other nodes in the pool must all be able to resolve this hostname correctly via `/etc/hosts` or a name resolution mechanism. The default for `hostname` is the value for *LogicalHostname*; therefore, you must supply a value for this command if you use a value other than the hostname or an abbreviation of it for *LogicalHostname*.
- `nodeid` is an integer in the range 1 through 32767 that is unique among the nodes in the pool. If you do not specify a number, FailSafe will calculate an ID for you. The default ID is a 5-digit number based on the machine's serial number and other machine-specific information; it is not sequential.



**Caution:** You must not change the node ID number after the node has been defined.

---

- `node_function` specifies the CXFS function of the node. If you use prompting mode, you must enter one of the following:
  - `server_admin` for a node that you wish to use as a CXFS metadata server in a coexecution cluster.
  - `client_admin`, for a node that will not be used as a CXFS metadata serverA FailSafe node cannot have the `client-only` function; this function is for CXFS-only nodes.
- `partition_id` uniquely defines a partition in a partitioned SGI Origin 3000 system.

---

**Note:** Use the `mkpart` command to determine this value:

- The `-n` option lists the partition ID (which is 0 if the system is not partitioned).
- The `-l` option lists the bricks in the various partitions (use `rack#.slot#` format in `cmgr`).

For example (output truncated here for readability):

```
# mkpart -n
Partition id = 1
# mkpart -l
partition: 3 = brick: 003c10 003c13 003c16 ...
partition: 1 = brick: 001c10 001c13 001c16 ...
```

You could enter one of the following for the **Partition ID** field:

```
1
001.10
```

---

If your system is not partitioned, use a value of 0.

To unset the partition ID, use a value of 0 or none.

- `reset_type` can be one of the following:
  - `powerCycle` to turn power off and on
  - `reset` to perform a serial reset
  - `nmi` to perform a nonmaskable interrupt
- `sysctrl_type` is the system controller type, based on the node hardware, as shown in Table 6-1 on page 161.
- `sysctrl_password` is the password for the system controller port, not the node's root password or PROM password. On some nodes, the system administrator may not have set this password. If you wish to set or change the system controller password, consult the hardware manual for your node.
- `sysctrl_status` is either enabled or disabled. This allows you to provide information about the system controller but temporarily disable by setting this value to `disabled` (meaning that FailSafe cannot reset the node). To allow FailSafe to reset the node, enter `disabled`.

- `sysctrl_owner` is the logical name of the node that can reset this node via the system controller port. A node may reset another node when it detects that the node is not responding to heartbeat messages or is not responding correctly to requests. A serial hardware reset cable must physically connect one of the owner's serial ports to the system controller port of the node being defined. The owner must be a node in the pool. (You can specify the name of a node that is not yet defined. However, the owner must be defined as a node before the node connectivity diagnostic test is run and before the cluster is activated.)
- `sysctrl_device` is the system controller device. `/dev/ttyd2` is the only legal value.
- `sysctrl_owner_type` is the name of the terminal port (TTY) on the owner node to which the system controller is connected, such as `/dev/ttyd2`. The other end of the cable connects to this node's system controller port, so the node can be controlled remotely by the other end.
- `is_failsafe` and `is_cxfs` specify the node type. If you are running just FailSafe on this node, set `is_failsafe` to `true`. If you are running both CXFS and FailSafe on this node in a coexecution cluster, set both values to `true`.
- `nic` is the IP address or hostname of the private network. (The hostname must be resolved in the `/etc/hosts` file.)

There can be up to eight network interfaces. SGI recommends that this network be private; see "Private Network" on page 9.

The priorities of the networks must be the same for each node in the cluster. For more information about using the hostname, see "System File Configuration" on page 69. For information about why a private network is required, see "Private Network" on page 9.

---

**Note:** The `set hierarchy` command is ignored for FailSafe-only nodes.

---

**Table 6-1** System Controller Types

11	12	mmsc	msc
Origin 300	Origin 3400	SGI 2400 rackmount	Origin 200
Origin 3200c	Origin 3800	SGI 2800 rackmount	Onyx2 deskside

l1	l2	mmsc	msc
Onyx 300	Origin 300 with NUMAlink module	Onyx2 rackmount	SGI 2100 deskside
Onyx 3200c	Onyx 3000 series		SGI 2200 deskside

Use the `add nic` command to define the network interfaces. When you enter this command, the following prompt appears:

```
NIC - nic#?
```

When this prompt appears, you use the following commands to specify the flags for the control network:

```
set heartbeat to true|false
set ctrl_msgs to true|false
set priority to integer
```

Use the following command from the node name prompt to remove a network controller:

```
remove nic IPaddress
```

When you have finished defining a node, enter `done`.

The following example defines a FailSafe node called `cm1a`, with one controller:

```
cmgr> define node cm1a
Enter commands, you may enter "done" or "cancel" at any time to exit

cm1a? set hostname to cm1a
cm1a? set nodeid to 1
cm1a? set reset_type to powerCycle
cm1a? set sysctrl_type to msc
cm1a? set sysctrl_password to [ ]
cm1a? set sysctrl_status to enabled
cm1a? set sysctrl_owner to cm2
cm1a? set sysctrl_device to /dev/ttyd2
cm1a? set sysctrl_owner_type to tty
cm1a? set is_failsafe to true
cm1a? set is_cxfs to false
cm1a? add nic cm1
Enter network interface commands, when finished enter "done"
or "cancel"
```

```
NIC - cm1 > set heartbeat to true
NIC - cm1 > set ctrl_msgs to true
NIC - cm1 > set priority to 0
NIC - cm1 > done
cm1a? done
```

If you have invoked `cmgr` with the `-p` option or you entered the `set` prompting on command, the display appears as in the following example:

```
cmgr> define node cm1a
Enter commands, when finished enter either "done" or "cancel"

Hostname[optional]? cm1a
Is this a FailSafe node <true|false> ? true
Is this a CXFS node <true|false> ? false
Node Function <server_admin|client_admin ? client_admin
Node ID ? 1
Reset type <powerCycle|reset|nmi> ? (powerCycle)
Do you wish to define system controller info[y/n]:y
Sysctrl Type <msc|mmsc|l2|l1>? (msc) msc
Sysctrl Password [optional]? ( )
Sysctrl Status <enabled|disabled>? enabled
Sysctrl Owner? cm2
Sysctrl Device? /dev/ttyd2
Sysctrl Owner Type <tty> [tty]?
Number of Network interfaces [2]? 2
NIC 1 - IP Address? 192.56.50.1
NIC 1 - Heartbeat HB (use network for heartbeats) <true|false>? true
NIC 1 - (use network for control messages) <true|false>? true
NIC 1 - Priority <1,2,...>? 1
NIC 2 - IP Address? 192.56.50.2
NIC 2 Heartbeat HB (use network for heartbeats) <true|false>? true
NIC 2 - (use network for control messages) <true|false>? false
NIC 2 - Priority <1,2,...>? 2
```

## Add or Remove Nodes in the Cluster

This section describes how to add or remove nodes.

### Add or Remove Nodes in the Cluster with the GUI

After you have added nodes to the pool and defined the cluster, you can indicate which of those nodes to include in the cluster.

---

**Note:** Do not add or remove nodes until the cluster icon appears in the view area; select **View: Nodes in Cluster**.

---

Do the following:

1. Add or remove the desired nodes:
  - To add a node, select its logical name from the **Available Nodes** menu and click **Add**. The node name will appear in the **Nodes to Go into Cluster** list.
  - To delete a node, click on its logical name in the **Nodes to Go into Cluster** list. (The logical name will be highlighted.) Then click **Remove**.
2. Click **OK** to complete the task.

## Modify a Node Definition

This section describes how to modify a node definition.

### Modify a Node Definition with the GUI

---

**Note:** If you want to rename a node, you must delete it and then define a new node.

---

To modify a node, do the following:

1. **Logical Name:** select the logical name of the node. After you do this, information for this node will be filled into the various fields.
2. Change the information in the appropriate field as follows:
  - **Networks for Incoming Cluster Messages:** the priorities of the networks must be the same for each node in the cluster.



- **Network:** if you want to add a network for incoming cluster messages, enter the IP address or hostname into the **Network** text field and click **Add**.
  - If you want to modify a network that is already in the list, click the network in the list in order to select it. Then click on **Modify**. This moves the network out of the list and into the text entry area. You can then change it. To add it back into the list, click **Add**.
  - If you want to delete a network, click on the network in the priority list in order to select it. Then click **Delete**.
  - If you want to change the priority of a network, click the network in the priority list in order to select it. Then click the up and down arrows in order to move it to a different position in the list.
- **Partition ID:** (*optional*) uniquely defines a partition in a partitioned SGI Origin 3000 system. If your system is not partitioned, leave this field empty.

---

**Note:** Use the `mkpart` command to determine the partition ID value:

- The `-n` option lists the partition ID (which is 0 if the system is not partitioned).
- The `-l` option lists the bricks in the various partitions (use `rack#.slot#` format in `cmgr`).

For example (output truncated here for readability):

```
# mkpart -n
Partition id = 1
# mkpart -l
partition: 3 = brick: 003c10 003c13 003c16 ...
partition: 1 = brick: 001c10 001c13 001c16 ...
```

You could enter one of the following for the **Partition ID** field:

```
1
001.10
```

---

Click **Next** to move to the next page.

- You can choose whether or not to use the system controller port to reset the node. If you want FailSafe to be able to use the system controller to reset the

node, you select the **Set Reset Parameters** checkbox and provide the following information:

- This node:
  - **Port Type:** select **L1** (L1 system controller for Origin 300, Origin 3200C, Onyx 300, and Onyx 3200C systems), **L2** (L2 system controller for Origin 3400, Origin 3800, Origin 300 with NUMAlink module, and Onyx 3000 series), **MSC** (module system controller for Origin 200, Onyx2 deskside, and SGI 2100, 2200 deskside systems ), or **MMSC** (multimodule system controller for rackmount SGI 2400, SGI 2800 and Onyx2 systems).
  - **Port Password:** the password for the system controller port, **not** the node's `root` password or PROM password. On some machines, the system administrator may not have set this password. If you wish to set or change the system controller port password, consult the hardware manual for your node.
  - **Temporarily Disable Port:** if you want to provide reset information now but do not want to allow the reset capability at this time, check this box. If this box is checked, FailSafe cannot reset the node.
- Owner (node that sends reset command):
  - **Logical Name:** name of the node that sends the remote reset command. Serial cables must physically connect the node being defined and the owner node through the system controller port. At run time, the node must be defined in the pool.

You can select a logical name or enter the logical name of a node that is not yet defined. However, you must define the node before you run the node connectivity diagnostics task.

- **TTY Device:** name of the terminal port (TTY) on the owner node to which the system controller is connected, such as `/dev/ttyd2`. The other end of the cable connects to this node's system controller port, so the node can be controlled remotely by the other node.

If you do not want to use the reset function at all, click the **Set System Controller Parameters** box to deselect (uncheck) it.

3. Click **OK** to complete the task.

## Modify a Node Definition with `cmgr`

To modify an existing node, use the following commands:

```
modify node LogicalHostname
  set hostname to Hostname
  set partition_id to PartitionID
  set reset_type to powerCycle|reset|nmi
  set sysctrl_type to msc|mmsc|I2|I1 (based on node hardware)
  set sysctrl_password to Password
  set sysctrl_status to enabled|disabled
  set sysctrl_owner to node_sending_reset_command
  set sysctrl_device to /dev/ttyd2
  set sysctrl_owner_type to tty_device
  set is_failsafe to true|false
  set is_cxfs to true|false
  add nic IPAddress_Or_Hostname (if DNS)
    set heartbeat to true|false
    set ctrl_msgs to true|false
    set priority to integer
  remove nic IPAddress_Or_Hostname (if DNS)
```

---

**Note:** The `set hierarchy` command is ignored for Failsafe-only nodes.

---

The commands are the same as those used to define a node. You can change any of the information you specified when defining a node except the node ID. For details about the commands, see "Define a Node with `cmgr`" on page 158.

There are additional commands that apply to CXFS; if you are running a coexecution cluster, see *CXFS Administration Guide for SGI InfiniteStorage* for more information.

---



**Caution:** To change node ID, you must delete the node and define the node with a new node ID.

---

## Example of Partitioning

The following shows an example of partitioning an SGI Origin 3000 system:

```
# cmgr
Welcome to SGI Cluster Manager Command-Line Interface
```

```
cmgr> modify node n_preston
Enter commands, when finished enter either "done" or "cancel"

n_preston ? set partition_id to 1
n_preston ? done

Successfully modified node n_preston
```

To perform this function with prompting, enter the following:

```
# cmgr -p
Welcome to SGI Cluster Manager Command-Line Interface

cmgr> modify node n_preston
Enter commands, you may enter "done" or "cancel" at any time to exit

Hostname[optional] ? (preston.dept.company.com)
Is this a FailSafe node <true|false> ? (true)
Is this a CXFS node <true|false> ? (true)
Node ID[optional] ? (606)
Partition ID[optional] ? (0) 1
Reset type <powerCycle|reset|nmi> ? (powerCycle)
Do you wish to modify system controller info[y/n]:n
Number of Network Interfaces ? (2)
NIC 1 - IP Address ? (192.168.168.2)
NIC 1 - Heartbeat HB (use network for heartbeats) <true|false> ? (true)
NIC 1 - (use network for control messages) <true|false> ? (true)
NIC 1 - Priority <1,2,...> ? (1)
NIC 2 - IP Address ? (192.168.168.1)
NIC 2 - Heartbeat HB (use network for heartbeats) <true|false> ? (true)
NIC 2 - (use network for control messages) <true|false> ? (true)
NIC 2 - Priority <1,2,...> ? (2)
Node Weight ? (1)

Successfully modified node n_preston

cmgr> show node n_preston
Logical Machine Name: n_preston
Hostname: preston.dept.company.com
Node Is FailSafe: true
Node Is CXFS: true
```

```
Nodeid: 606
Partition id: 1
Reset type: powerCycle
ControlNet Ipaddr: 192.168.168.2
ControlNet HB: true
ControlNet Control: true
ControlNet Priority: 1
ControlNet Ipaddr: 192.168.168.1
ControlNet HB: true
ControlNet Control: true
ControlNet Priority: 2
Node Weight: 1
```

To unset the partition ID, use a value of 0 or none.

## Convert a CXFS Node to FailSafe

This section tells you how to convert a FailSafe node to also apply to CXFS.

### Convert a CXFS Node to FailSafe with the GUI

This task appears on the GUI if you also have CXFS installed.

To convert an existing CXFS node (of type CXFS) to type CXFS and FailSafe or type FailSafe, do the following:

1. Stop CXFS services on the node to be converted using the CXFS GUI. See the *CXFS Administration Guide for SGI InfiniteStorage*.
2. Convert the node:
  - **Logical Name:** select the logical name of the node.
  - **Keep CXFS Settings:**
    - To convert to type CXFS and FailSafe, click the checkbox
    - To convert to type FailSafe, leave the checkbox blank
  - Click **OK** to complete the task.

---

**Note:** If you want to rename a node, you must delete it and then define a new node.

---

To change other parameters, see "Modify a Node Definition with the GUI" on page 164. Ensure that modifications you make are appropriate for both FailSafe and CXFS.

### Convert a Node to CXFS or FailSafe with `cmgr`

To convert an existing CXFS node so that it also applies to Failsafe, use the `modify` command to change the setting.

---

**Note:** You cannot turn off FailSafe or CXFS for a node if the respective HA or CXFS services are active. You must first stop the services for the node.

---

For example, in normal mode:

```
cmgr> modify node cxfs6
Enter commands, when finished enter either "done" or "cancel"

cxfs6 ? set is_FailSafe to true
cxfs6 ? done

Successfully modified node cxfs6
```

For example, in prompting mode:

```
cmgr> modify node cxfs6
Enter commands, you may enter "done" or "cancel" at any time to exit

Hostname[optional] ? (cxfs6.americas.sgi.com)
Is this a FailSafe node <true|false> ? (false) true
Is this a CXFS node <true|false> ? (true)
Node ID[optional] ? (13203)
Partition ID[optional] ? (0)
Reset type <powerCycle|reset|nmi> ? (powerCycle)
Do you wish to modify system controller info[y/n]:n
Number of Network Interfaces ? (1)
NIC 1 - IP Address ? (cxfs6)
NIC 1 - Heartbeat HB (use network for heartbeats) <true|false> ? (true)
NIC 1 - (use network for control messages) <true|false> ? (true)
NIC 1 - Priority <1,2,...> ? (1)
Node Weight ? (0)

Successfully modified node cxfs6
```

## Delete a Node

This section tells you how to delete a node.

### Delete a Node with the GUI

You must remove a node from a cluster before you can delete the node from the pool. For information, see "Modify a Cluster Definition" on page 179.

To delete a node, do the following:

1. **Node to Delete:** select the logical name of the node to be deleted.
2. Click **OK** to complete the task.

### Delete a Node with `cmgr`

To delete a node, use the following command:

```
delete node Nodename
```

You can delete a node only if the node is not currently part of a cluster. If a cluster currently contains the node, you must first modify that cluster to remove the node from it.

For example, suppose you had a cluster named `cxfs6-8` with the following configuration:

```
cmgr> show cluster cxfs6-8
Cluster Name: cxfs6-8
Cluster Is FailSafe: true
Cluster Is CXFS: true
Cluster ID: 20
Cluster HA mode: normal
Cluster CX mode: normal
```

```
Cluster cxfs6-8 has following 3 machine(s)
  cxfs6
  cxfs7
  cxfs8
```

To delete node `cxfs8`, you would do the following in prompting mode (assuming that CXFS services and FailSafe HA services have been stopped on the node):

```
cmgr> modify cluster cxfs6-8  
Enter commands, when finished enter either "done" or "cancel"
```

```
Is this a FailSafe cluster <true|false> ? (true)  
Is this a CXFS cluster <true|false> ? (true)  
Cluster Notify Cmd [optional] ?  
Cluster Notify Address [optional] ?  
Cluster HA mode <normal|experimental>[optional] ? (normal)  
Cluster ID ? (20)  
Number of Cluster FileSystems ? (0)
```

```
Current nodes in cluster cxfs6-8:  
Node - 1: cxfs6  
Node - 2: cxfs7  
Node - 3: cxfs8
```

```
Add nodes to or remove nodes from cluster cxfs6-8  
Enter "done" when completed or "cancel" to abort
```

```
cxfs6-8 ? remove node cxfs8  
cxfs6-8 ? done  
Successfully modified cluster cxfs6-8
```

```
cmgr> show cluster cxfs6-8  
Cluster Name: cxfs6-8  
Cluster Is FailSafe: true  
Cluster Is CXFS: true  
Cluster ID: 20  
Cluster HA mode: normal
```

```
Cluster cxfs6-8 has following 2 machine(s)  
    cxfs6  
    cxfs7
```

To delete `cxfs8` from the pool, enter the following:

```
cmgr> delete node cxfs8
```



IMPORTANT: NODE cannot be deleted if it is a member of a cluster.  
The LOCAL node can not be deleted if some other nodes are still defined.

Deleted machine (cxfs6).

## Display a Node

This section tells you how to display a node.

### Display a Node with the GUI

After you define nodes, you can display the following:

- Nodes that have been defined (**Nodes in Pool**)
- Nodes that are members of a specific cluster (**Nodes in Cluster**)
- Attributes of a node

Click any name or icon in the view area to see detailed status and configuration information in the details area.

### Display a Node with `cmgr`

After you have defined a node, you can display the node's parameters with the following command:

```
show node Nodename
```

A `show node` command on node `cm1a` would yield the following display:

```
cmgr> show node cm1  
Logical Machine Name: cm1  
Hostname: cm1  
Node Is FailSafe: true  
Node is CXFS: false  
Nodeid: 1  
Reset type: powerCycle  
System Controller: msc  
System Controller status: enabled  
System Controller owner: cm2  
System Controller owner device: /dev/ttyd2
```

```
System Controller owner type: tty
ControlNet Ipaddr: 192.56.50.1
ControlNet HB: true
ControlNet Control: true
ControlNet Priority: 0
```

You can see a list of all of the nodes that have been defined with the following command:

```
show nodes in pool
```

For example:

```
cmgr> show nodes in pool

3 Machine(s) defined
    cxf8
    cxf6
    cxf7
```

You can show the nodes in the cluster with the following command:

```
show nodes in cluster Clustername
```

For example, if node `cxf8` was in the pool but not in `clusterA`, you would see:

```
cmgr> show nodes in cluster clusterA

Cluster clusterA has following 2 machine(s)
    cxf6
    cxf7
```

## Cluster Tasks

The *cluster* is the set of nodes in the pool that have been defined as a cluster. The cluster is identified by a simple name; this name must be unique within the pool. (For example, you cannot use the same name for the cluster and for a node.)

All nodes in the cluster are also in the pool. However, all nodes in the pool are not necessarily in the cluster; that is, the cluster may consist of a subset of the nodes in the pool. There is only one cluster per pool.

This section describes the following cluster configuration tasks:

- "Define a Cluster"
- "Modify a Cluster Definition" on page 179
- "Convert a CXFS Cluster to FailSafe" on page 181
- "Delete a Cluster" on page 182
- "Display a Cluster" on page 184

## Define a Cluster

This section tells you how to define a cluster.

### Define a Cluster with the GUI

A *cluster* is a collection of nodes coupled to each other by a private network. A cluster is identified by a simple name. A given node may be a member of only one cluster.

To define a cluster, do the following:

1. Enter the following:

- **Cluster Name:** the logical name of the cluster. The name can have a maximum length of 255 characters. Clusters that share a network and use XVM must have unique names.
- **Cluster Mode:** usually, you should choose the default `Normal` mode.

Choosing `Experimental` turns off resetting so that you can debug the cluster without causing node resets. You should only use `Experimental` mode when debugging.

- **Notify Administrator** (of cluster and node status changes):
  - **By e-mail:** this choice requires that you specify the e-mail program (by default, `/usr/sbin/Mail`) and the e-mail addresses of those to be identified. To specify multiple addresses, separate them with commas. FailSafe will send e-mail to the addresses whenever the status changes for a node or cluster. If you do not specify an address, notification will not be sent.

- **By other command:** this choice requires that you specify the command to be run whenever the status changes for a node or cluster.
  - **Never:** this choice specifies that notification is not sent.
2. Click **OK** to complete the task. This is a long-running task that might take a few minutes to complete.

### Define a Cluster with `cmgr`

When you define a cluster with `cmgr`, you define a cluster and add nodes to the cluster with the same command. For general information, see "Define a Cluster" on page 175.

Use the following commands to define a cluster:

```
define cluster Clustername
  set is_failsafe to true|false
  set is_cxfs to true|false
  set notify_cmd to NotifyCommand
  set notify_addr to Email_address
  set ha_mode to normal|experimental
  set cx_mode to normal|experimental
  add node Node1name
  add node Node2name
  ...
```

Usage notes:

- `cluster` is the logical name of the cluster. Logical names cannot begin with an underscore (`_`) or include any whitespace characters, and can be at most 255 characters.
- `is_failsafe` and `is_cxfs` specify the cluster type. If you are running just FailSafe, set `is_failsafe` to `true`. If you are running a coexecution cluster, set both values to `true`.
- `notify_cmd` is the command to be run whenever the status changes for a node or cluster.
- `notify_addr` is the email address to be notified of cluster and node status changes. To specify multiple addresses, separate them with commas. FailSafe will send e-mail to the addresses whenever the status changes for a node or cluster. If you do not specify an address, notification will not be sent. If you use the

notify\_addr command, you must specify the e-mail program (by default, /usr/sbin/Mail )as the *NotifyCommand*.

- set ha\_mode and set cx\_mode should normally be set to normal. Setting the mode to experimental turns off resetting so that you can debug the cluster without causing node resets. You should only use experimental mode when debugging. The set cx\_mode command applies only to CXFS, and the set ha\_mode command applies only to FailSafe.

This is a long-running task that might take a few minutes to complete. Failsafe also adds the resource types that are installed in the node to the new cluster; this process takes time.

The following shows the commands with prompting:

```
cmgr> define cluster Clustername
Enter commands, you may enter "done" or "cancel" at any time to exit

Is this a FailSafe cluster <true|false> ? true|false
Is this a CXFS cluster <true|false> ? true|false
Cluster Notify Cmd [optional] ?
Cluster Notify Address [optional] ?
Cluster HA mode <normal|experimental> [optional] ? normal
No nodes in cluster Clustername

Add nodes to or remove nodes from cluster Clustername
Enter "done" when completed or "cancel" to abort

Clustername ? add node Node1name
Clustername ? add node Node2name
...
Clustername ? done
Creating resource type MAC_address
Creating resource type IP_address
Creating resource type filesystem
Creating resource type volume
Successfully defined cluster Clustername

Added node <node1name> to cluster <clustername>
Added node <node2name> to cluster <clustername>
```

You should set the cluster to the default normal mode. Setting the mode to Experimental turns off resetting so that you can debug the cluster without causing

node resets. You should only use `Experimental` mode when debugging. However, you should never use `experimental` mode on a production cluster and should only use it if directed to by SGI customer support. SGI does not support the use of `experimental` by customers.

For example:

```
cmgr> define cluster fs6-8  
Enter commands, you may enter "done" or "cancel" at any time to exit
```

```
Is this a FailSafe cluster <true|false> ? true  
Is this a CXFS cluster <true|false> ? false  
Cluster Notify Cmd [optional] ?  
Cluster Notify Address [optional] ?  
Cluster HA mode <normal|experimental> [optional] ?
```

```
No nodes in cluster fs6-8
```

```
Add nodes to or remove nodes from cluster fs6-8  
Enter "done" when completed or "cancel" to abort
```

```
fs6-8 ? add node fs6  
fs6-8 ? add node fs7  
fs6-8 ? add node fs8  
fs6-8 ? done  
Creating resource type MAC_address  
Creating resource type IP_address  
Creating resource type filesystem  
Creating resource type volume  
Successfully defined cluster fd6-8
```

```
Added node <fs6> to cluster <fs6-8>  
Added node <fs7> to cluster <fs6-8>  
Added node <fs8> to cluster <fs6-8>
```

To do this without prompting, enter the following:

```
cmgr> define cluster fs6-8  
Enter commands, you may enter "done" or "cancel" at any time to exit
```

```
cluster fs6-8? set is_failsafe to true  
cluster fs6-8? add node fs6
```

```
cluster fs6-8? add node fs7
cluster fs6-8? add node fs8
cluster fs6-8? done
Creating resource type MAC_address
Creating resource type IP_address
Creating resource type filesystem
Creating resource type volume
Successfully defined cluster fs6-8
```

## Modify a Cluster Definition

This section tells you how to modify a cluster definition.

### Modify a Cluster Definition with the GUI

To change how the cluster administrator is notified of changes in the cluster's state, do the following:

1. **Cluster Name:** select the name of the cluster.
2. **Cluster Mode:** usually, you should set the cluster to the default **Normal** mode. See "Define a Cluster" on page 175, for information about **Experimental** mode.
3. **Notify Administrator** (of cluster and node status changes):
  - **By e-mail:** this choice requires that you specify the e-mail program (by default `/usr/sbin/Mail`) and the e-mail addresses of those to be identified. To specify multiple addresses, separate them with commas. FailSafe will send e-mail to the addresses whenever the status changes for a node or cluster. If you do not specify an address, notification will not be sent.
  - **By other command:** this choice requires that you specify the command to be run whenever the status changes for a node or cluster.
  - **Never:** this choice specifies that notification is not sent.
4. Click **OK**.

To modify the nodes that make up a cluster, see "Add or Remove Nodes in the Cluster with the GUI" on page 164.

---

**Note:** If you want to rename a cluster, you must delete it and then define a new cluster.

---

### Modify a Cluster Definition with `cmgr`

The commands are as follows:

```
modify cluster Clustername
  set is_failsafe to true
  set is_cxfs to true
  set notify_cnd to command
  set notify_addr to EmailAddress
  set ha_mode to normal|experimental
  set cx_mode to normal|experimental
  add node Node1name
  add node Node2name
  ...
  remove node Node1name
  remove node Node2name...
```

The following is an example of adding a node to a cluster in prompting mode:

```
cmgr> modify cluster nfs-cluster
Enter commands, you may enter "done" or "cancel" at any time to exit

Is this a FailSafe cluster <true|false> ? (true)
Is this a CXFS cluster <true|false> ? (false)
Cluster Notify Cmd [optional] ?
Cluster Notify Address [optional] ?
Cluster HA mode <normal|experimental>[optional] ? (normal)

Current nodes in cluster nfs-cluster:
Node - 1: hans1

No networks in cluster nfs-cluster

Add nodes to or remove nodes/networks from cluster nfs-cluster
Enter "done" when completed or "cancel" to abort
```



```
nfs-cluster ? add node hans2
nfs-cluster ? done
Added node <hans2> to cluster <nfs-cluster>
Successfully modified cluster nfs-cluster
```

---

**Note:** All references to networks in the prompting-mode output are for CXFS clusters only. You must configure FailSafe networks as part of the node definition.

---

## Convert a CXFS Cluster to FailSafe

This section tells you how to convert a CXFS cluster so that it also applies to FailSafe.

### Convert a CXFS Cluster to FailSafe with the GUI

This task appears on the GUI if you also have CXFS installed.

To convert the information from an existing CXFS cluster (that is, of type CXFS) to create a cluster that also applies to FailSafe (that is, of type CXFS and FailSafe), do the following:

1. **Cluster Name:** select the name of the cluster.
2. Click **OK** to complete the task.

The cluster will apply to both FailSafe and CXFS. To modify the nodes that make up a cluster, see "Add or Remove Nodes in the Cluster" on page 164.

---

**Note:** If you want to rename a cluster, you must delete it and then define a new cluster.

---

### Converting a CXFS Cluster to Failsafe with `cmgr`

To convert a cluster with `cmgr`, use the `modify cluster` command then the following commands:

```
modify cluster Clustername
  set is_failsafe to true|false
  set is_cxfs to true|false
  set clusterid to clusterID
```

For example, to convert CXFS cluster TEST so that it also applies to FailSafe, enter the following:

```
cmgr> modify cluster TEST  
Enter commands, when finished enter either "done" or "cancel"
```

```
TEST ? set is_failsafe to true
```

The cluster must support all of the functionalities (FailSafe and/or CXFS) that are turned on for its nodes; that is, if your cluster is of type CXFS, then you cannot modify a node that is part of the cluster so that the node is of type FailSafe or CXFS and FailSafe. However, the nodes do not have to support all the functionalities of the cluster; that is, you can have a node of type CXFS in a cluster of type CXFS and FailSafe.

## Delete a Cluster

This section tells you how to delete a cluster.

### Delete a Cluster with the GUI

You cannot delete a cluster that contains nodes; you must first remove all nodes from the cluster. See "Add or Remove Nodes in the Cluster with the GUI" on page 164.

To delete a cluster, do the following:

1. **Cluster to Delete:** select the cluster name.
2. Click **OK** to complete the task.

### Delete a Cluster with cmgr

You cannot delete a cluster that contains nodes; you must first remove all nodes from the cluster.

To delete a cluster, use the following command:

```
delete cluster Clustername
```

Example in normal mode:

```
cmgr> modify cluster fs6-8  
Enter commands, when finished enter either "done" or "cancel"
```

```
fs6-8 ? remove node fs6
fs6-8 ? remove node fs7
fs6-8 ? remove node fs8
fs6-8 ? done
Successfully modified cluster fs6-8
```

```
cmgr> delete cluster fs6-8
```

```
cmgr> show clusters
```

```
cmgr>
```

Example using prompting:

```
cmgr> modify cluster fs6-8
Enter commands, you may enter "done" or "cancel" at any time to exit
```

```
Cluster Notify Cmd [optional] ?
Cluster Notify Address [optional] ?
Cluster HA mode <normal|experimental>[optional] ? (normal)
```

```
Current nodes in cluster fs6-8:
Node - 1: fs6
Node - 2: fs7
Node - 3: fs8
```

```
Add nodes to or remove nodes from cluster fs6-8
Enter "done" when completed or "cancel" to abort
```

```
fs6-8 ? remove node fs6
fs6-8 ? remove node fs7
fs6-8 ? remove node fs8
fs6-8 ? done
Successfully modified cluster fs6-8
```

```
cmgr> delete cluster fs6-8
```

```
cmgr> show clusters
```

```
cmgr>
```

## Display a Cluster

This section tells you how to display a cluster.

### Display a Cluster with the GUI

The GUI provides a convenient display of a cluster and its components. From the **View** selection, you can choose elements within the cluster to examine. To view details of the cluster, click on the cluster name or icon.

The status details will appear in the details area on the right side of the GUI screen.

### Display a Cluster with `cmgr`

After you have defined a cluster, you can display the nodes in that cluster with the following commands:

```
show clusters
show cluster Clustername
```

For example:

```
cmgr> show clusters

1 Cluster(s) defined
    nfs-cluster

cmgr> show cluster nfs-cluster
Cluster Name: nfs-cluster
Cluster Is FailSafe: true
Cluster Is CXFS: false
Cluster HA mode: normal

Cluster nfs-cluster has following 2 machine(s)
    hans2
    hans1
```

## Resource Type Tasks

A *resource type* is a particular class of resource. All of the resources in a particular resource type can be handled in the same way for the purposes of failover. Every resource is an instance of exactly one resource type.

This section describes the following resource type tasks:

- "Define a Resource Type"
- "Redefine a Resource Type for a Specific Node" on page 194
- "Add/Remove Dependencies for a Resource Type" on page 198
- "Load a Resource Type" on page 201
- "Modify a Resource Type Definition" on page 201
- "Delete a Resource Type" on page 206
- "Display a Resource Type" on page 207

### Define a Resource Type

This section describes how to define a resource type.

#### Define a Resource Type with the GUI

The FailSafe software includes many predefined resource types. Resource types in the cluster are created for the FailSafe plug-ins installed in the node using the `/usr/cluster/bin/cdb-create-resource-type` script. Resource types that were not created when the cluster was configured can be added later using the `resource type install` command, as described in "Load a Resource Type with the GUI" on page 201.

If these predefined resource types fit the application you want to make into an HA service, you can reuse them. If none fits, you can define additional resource types. Complete information on defining resource types is provided in the *FailSafe Programmer's Guide for SGI Infinite Storage*. This manual provides a summary of that information.

To define a new resource type, do the following:

1. **Resource Type:** specify the name of the new resource type, with a maximum length of 255 characters.

Click **Next** to move to the next page.

2. Specify settings for required actions (time values are in milliseconds):

- **Start/Stop Order:** order of performing the action scripts for resources of this type in relation to resources of other types:
  - Resources are started in the increasing order of this value.
  - Resources are stopped in the decreasing order of this value.

See the *FailSafe Programmer's Guide for SGI Infinite Storage* for a full description of the order ranges available.

- **Start Timeout:** the maximum duration for starting a resource of this type.
- **Stop Timeout:** the maximum duration for stopping a resource of this type.
- **Exclusive Timeout:** the maximum duration for verifying that a resource of this type is not already running.
- **Monitor Timeout:** the maximum duration for monitoring a resource of this type.
- **Monitor Interval:** the amount of time between successive executions of the `monitor` action script; this is only valid for the `monitor` action script.
- **Monitor Start Time:** the amount of time between starting a resource and beginning monitoring of that resource.

Click **Next** to move to the next page.

3. Specify settings for optional actions as needed:

- **Restart Enabled:** check the box to enable restarting of the resource. You should enable restart if you want a resource of this type to automatically be restarted on the current node after a monitoring failure. Enabling restart can decrease application downtime.

For example, suppose FailSafe detects that a resource's monitor action has failed:

- If restart is disabled, FailSafe will immediately attempt to move the whole group to another node in the failover domain. The application will be down until the entire group is failed over.
- If restart is enabled, FailSafe will attempt to restart the resource on the current node where the rest of the resource group is running. If this succeeds, the resource group will be made available as soon as the resource restarts; if this fails, only then will FailSafe attempt to move the whole group to another node in the failover domain.

The local restart flag enables local failover:

- If local restart is enabled and the resource monitor script fails, SRMD executes the restart script for the resource.
- If the restart script is successful, SRMD continues to monitor the resource.
- If the restart script fails or the restart count is exhausted, SRMD sends a resource group monitoring error to FSD. FSD itself is not involved in local failover.

To determine the number of local monitoring failures, use the `show status of resource` command to `cmgr`; for more information, see "Querying Resource Status with `cmgr`" on page 302.

When a resource is restarted, all other resources in the resource group are not restarted. It is not possible to do a local restart of a resource using the GUI or `cmgr`.

If you find that you need to reset the restart counter for a resource type, you can put the resource group in maintenance mode and remove it from maintenance mode. This process will restart counters for all resources in the resource group. For information on putting a resource group in maintenance mode, see "Suspend and Resume Monitoring of a Resource Group" on page 320.

- **Restart Timeout:** the maximum amount of time to wait before restarting the resource after a monitoring failure occurs.
- **Restart Count:** the maximum number of attempts that FailSafe will make to restart a resource of this type on the current node. Enter an integer greater than zero.

- **Probe Enabled:** check if you want FailSafe to verify that a resource of this type is configured on a node.
  - **Probe Timeout:** the maximum amount of time for FailSafe to attempt to verify that a resource of this type is configured on a node.
4. Change settings for type-specific attributes: specify any attributes specific to the resource type. You must provide the following for each attribute:
- **Attribute key:** name of the attribute
  - **Data Type:** select either **String** or **Integer**
  - **Default Value:** optionally, provide a default value

For example, NFS requires the following attributes:

- `export-point`, which takes a value that defines the export disk name. This name is used as input to the `exportfs` command. For example:  

```
export-point = /this_disk
```
- `export-info`, which takes a value that defines the export options for the filesystem. These options are used in the `exportfs` command. For example:  

```
export-info = rw,wsync,anon=root
```
- `filesystem`, which takes a value that defines the raw filesystem. This name is used as input to the `mount` command. For example:  

```
filesystem = /dev/xlv/xlv_object
```

Click **Add** to add the attribute, and repeat as necessary for other attributes.

5. Click **OK** to complete the task.

### Define a Resource Type with `cmgr`

Use the following commands:

```
define resource_type RTname on node Nodename [in cluster Clustername]  
  
define resource_type RTname [in cluster Clustername]  
  set order to start/stop_Order_Number  
  set restart_mode to 0|1
```



```
set restart_count to Number_Of_Attempts
add action ActionScriptname
    set exec_time to ExecutionTimeout
    set monitor_interval to MonitorInterval
    set monitor_time to MonitorTime
add type_attribute Type-specific_Attributename
    set data_type to string|integer
    set default_value to Default
add dependency RTname
remove action ActionScriptname
remove type_attribute Type-specific_Attributename
remove dependency DependencyName
```

Usage notes:

- `resource_type` is the name of the resource type to be defined, with a maximum length of 255 characters.
- `order` is the order of performing the action scripts for resources of this type in relation to resources of other types:
  - Resources are started in the increasing order of this value
  - Resources are stopped in the decreasing order of this value

See the *FailSafe Programmer's Guide for SGI Infinite Storage* for a full description of the order ranges available.

- `restart_mode` is as follows:
  - 0 = Do not restart on monitoring failures (disable restart)
  - 1 = Restart a fixed number of times (enable restart)

You should enable restart if you want a resource of this type to automatically be restarted on the current node after a monitoring failure. Enabling restart can decrease application downtime.

- `restart_count` is the maximum number of attempts that FailSafe will make to restart a resource of this type on the current node. Enter an integer greater than zero.

- `action` is the name of the action script (`exclusive`, `start`, `stop`, `monitor`, or `restart`). For more information, see "Action Scripts" on page 15. The following time values are in milliseconds:
  - `exec_time` is the maximum time for executing the action script
  - `monitor_interval` is the amount of time between successive executions of the `monitor` action script (this is valid only for the `monitor` action script)
  - `monitor_time` is the amount of time between starting a resource and beginning monitoring of that resource
- `type_attribute` is a type-specific attribute
  - `data_type` is either `string` or `integer`
  - `default_value` is the default value for the attribute
- `dependency` adds a dependency upon the specified resource type (*RTname*)

By default, the resource type will apply across the cluster; if you wish to limit the resource type to a specific node, enter the node name when prompted. If you wish to enable restart mode, enter 1 when prompted.

For an example in normal mode, see the template for the `cmgr` command in the following file:

```
/var/cluster/cmgr-templates/cmgr-create-resource_type
```

---

**Note:** The `cmgr-create-resource_type` script provides a general mechanism for creating a resource type. Each existing resource type has a `create_resource_type` script in its directory, such as `/var/cluster/ha/resource_types/statd_unlimited/create_resource_type`.

---

The following example in prompting mode only shows the prompts and answers for two action scripts (`start` and `stop`) for a new resource type named `newresourcetype`.

```
cmgr> define resource_type newresourcetype
```

```
(Enter "cancel" at any time to abort)
```

```
Node[optional]?
```

```
Order ? 300
```

Restart Mode ? (0)

DEFINE RESOURCE TYPE OPTIONS

- 0) Modify Action Script.
- 1) Add Action Script.
- 2) Remove Action Script.
- 3) Add Type Specific Attribute.
- 4) Remove Type Specific Attribute.
- 5) Add Dependency.
- 6) Remove Dependency.
- 7) Show Current Information.
- 8) Cancel. (Aborts command)
- 9) Done. (Exits and runs command)

Enter option:1

No current resource type actions

Action name ? **start**

Executable timeout (in milliseconds) ? **40000**

- 0) Modify Action Script.
- 1) Add Action Script.
- 2) Remove Action Script.
- 3) Add Type Specific Attribute.
- 4) Remove Type Specific Attribute.
- 5) Add Dependency.
- 6) Remove Dependency.
- 7) Show Current Information.
- 8) Cancel. (Aborts command)
- 9) Done. (Exits and runs command)

Enter option:1

Current resource type actions:

start

Action name **stop**

Executable timeout? (in milliseconds) **40000**

- 0) Modify Action Script.
- 1) Add Action Script.
- 2) Remove Action Script.
- 3) Add Type Specific Attribute.
- 4) Remove Type Specific Attribute.
- 5) Add Dependency.
- 6) Remove Dependency.
- 7) Show Current Information.
- 8) Cancel. (Aborts command)
- 9) Done. (Exits and runs command)

Enter option:3

No current type specific attributes

Type Specific Attribute ? **integer-att**  
Datatype ? **integer**  
Default value[optional] ? **33**

- 0) Modify Action Script.
- 1) Add Action Script.
- 2) Remove Action Script.
- 3) Add Type Specific Attribute.
- 4) Remove Type Specific Attribute.
- 5) Add Dependency.
- 6) Remove Dependency.
- 7) Show Current Information.
- 8) Cancel. (Aborts command)
- 9) Done. (Exits and runs command)

Enter option:3

Current type specific attributes:  
Type Specific Attribute - 1: integer-att

Type Specific Attribute ? **string-att**  
Datatype ? **string**  
Default value[optional] ? **rw**

- 0) Modify Action Script.
- 1) Add Action Script.

- 2) Remove Action Script.
- 3) Add Type Specific Attribute.
- 4) Remove Type Specific Attribute.
- 5) Add Dependency.
- 6) Remove Dependency.
- 7) Show Current Information.
- 8) Cancel. (Aborts command)
- 9) Done. (Exits and runs command)

Enter option:5

No current resource type dependencies

Dependency name ? **filesystem**

- 0) Modify Action Script.
- 1) Add Action Script.
- 2) Remove Action Script.
- 3) Add Type Specific Attribute.
- 4) Remove Type Specific Attribute.
- 5) Add Dependency.
- 6) Remove Dependency.
- 7) Show Current Information.
- 8) Cancel. (Aborts command)
- 9) Done. (Exits and runs command)

Enter option:7

Current resource type actions:

Action - 1: start  
Action - 2: stop

Current type specific attributes:

Type Specific Attribute - 1: integer-att  
Type Specific Attribute - 2: string-att

No current resource type dependencies

Resource dependencies to be added:

Resource dependency - 1: filesystem

- 0) Modify Action Script.
- 1) Add Action Script.
- 2) Remove Action Script.
- 3) Add Type Specific Attribute.
- 4) Remove Type Specific Attribute.
- 5) Add Dependency.
- 6) Remove Dependency.
- 7) Show Current Information.
- 8) Cancel. (Aborts command)
- 9) Done. (Exits and runs command)

```
Enter option:9  
Successfully defined resource_type newresourcetype
```

```
cmgr> show resource_types
```

```
template  
MAC_address  
newresourcetype  
IP_address  
filesystem  
volume
```

```
cmgr> exit  
#
```

To determine the number of local monitoring failures, use the `show status of resource` command to `cmgr`; for more information, see "Querying Resource Status with `cmgr`" on page 302.

## Redefine a Resource Type for a Specific Node

This section describes how to define a resource type that applies to a specific node. You must connect the GUI or execute the `cmgr` command on the node for which the resource type will be redefined.

### Redefine a Resource Type for a Specific Node with the GUI

This task lets you take an existing clusterwide resource type and redefine it for use on the local node.

A resource type that is redefined for a specific node overrides a clusterwide definition with the same name; this allows an individual node to override global settings from a clusterwide resource type definition. You can use this feature if you want to have different script timeouts for a node or you want to restart a resource on only one node in the cluster.

For example, the `IP_address` resource has local restart enabled by default. If you would like to have an `IP_address` type without local restart for a particular node, you can make a copy of the `IP_address` clusterwide resource type with all of the parameters the same except for restart mode, which you set to 0.

Do the following:

1. **Local Node:** the name of the local node is filled in for you. (If you wanted to make the resource type specific to a different node, you must connect the GUI to that node.)
2. **Clusterwide Resource Type:** select the name of the resource type you want to redefine for the local node.

Click **Next** to move to the next page.

3. Change settings for required actions as needed (time values are in milliseconds):

- **Start/Stop Order:** order of performing the action scripts for resources of this type in relation to resources of other types:
  - Resources are started in the increasing order of this value
  - Resources are stopped in the decreasing order of this value

See the *FailSafe Programmer's Guide for SGI Infinite Storage* for a full description of the order ranges available.

- **Start Timeout:** the maximum duration for starting a resource of this type.
- **Stop Timeout:** the maximum duration for stopping a resource of this type.
- **Exclusive Timeout:** the maximum duration for verifying that a resource of this type is not already running.
- **Monitor Timeout:** the maximum duration for monitoring a resource of this type.
- **Monitor Interval:** the amount of time between successive executions of the `monitor` action script; this is only valid for the `monitor` action script.

- **Monitor Start Time:** the amount of time between starting a resource and beginning monitoring of that resource.

Click **Next** to move to the next page.

4. Change settings for optional actions as needed:

- **Restart Enabled:** check the box to enable restarting of the resource. You should enable restart if you want a resource of this type to automatically be restarted on the current node after a monitoring failure. Enabling restart can decrease application downtime.

For example, suppose FailSafe detects that a resource's monitor action has failed:

- If restart is disabled, FailSafe will immediately attempt to move the whole group to another node in the failover domain. The application will be down until the entire group is failed over.
- If restart is enabled, FailSafe will attempt to restart the resource on the current node where the rest of the resource group is running. If this succeeds, the resource group will be made available as soon as the resource restarts; if this fails, only then will FailSafe attempt to move the whole group to another node in the failover domain.

The local restart flag enables local failover:

- If local restart is enabled and the resource monitor script fails, SRMD executes the restart script for the resource.
- If the restart script is successful, SRMD continues to monitor the resource.
- If the restart script fails or the restart count is exhausted, SRMD sends a resource group monitoring error to FSD. FSD itself is not involved in local failover.

When a resource is restarted, all other resources in the resource group are not restarted. It is not possible to do a local restart of a resource using the GUI or `cmgr`.

If you find that you need to reset the restart counter for a resource type, you can put the resource group in maintenance mode and remove it from maintenance mode. This process will restart counters for all resources in the resource group. For information on putting a resource group in maintenance



mode, see "Suspend and Resume Monitoring of a Resource Group" on page 320.

- **Restart Timeout:** the maximum amount of time to wait before restarting the resource after a monitoring failure occurs.
  - **Restart Count:** the maximum number of attempts that FailSafe will make to restart a resource of this type on the current node. Enter an integer greater than zero.
  - **Probe Enabled:** check if you want FailSafe to verify that a resource of this type is configured on a node.
  - **Probe Timeout:** the maximum amount of time for FailSafe to attempt to verify that a resource of this type is configured on a node.
5. Change settings for type-specific attributes; specify any attributes specific to the resource type. You must provide the following for each attribute:
- **Attribute key:** specify the name of the attribute
  - **Data Type:** select either **String** or **Integer**
  - **Default Value:** optionally, provide a default value

For example, NFS requires the following attributes:

- `export-point`, which takes a value that defines the export disk name. This name is used as input to the `exportfs` command. For example:  

```
export-point = /this_disk
```
- `export-info`, which takes a value that defines the export options for the filesystem. These options are used in the `exportfs` command. For example:  

```
export-info = rw,wsync,anon=root
```
- `filesystem`, which takes a value that defines the raw filesystem. This name is used as input to the `mount` command. For example:  

```
filesystem = /dev/xlv/xlv_object
```

Click **Add** to add the attribute, and repeat as necessary for other attributes.

6. Click **OK** to complete the task.

### Define a Node-Specific Resource Type with `cmgr`

With `cmgr`, you redefine a node-specific resource type similar to defining a clusterwide resource type, except that you specify a node on the command line. You must execute the command on that node.

Use the following command to define a node-specific resource type:

```
define resource_type RTname on node Nodename [in cluster Clustername]
```

### Add/Remove Dependencies for a Resource Type

This section describes how to add dependencies to a resource type.

#### Add/Remove Dependencies for a Resource Type with the GUI

Like resources, a resource type can be dependent on one or more other resource types. If such a dependency exists, at least one instance of each of the dependent resource types must be defined.

For example, a resource type named `Netscape_web` might have resource type dependencies on a resource type named `IP_address` and `volume`. If a resource named `ws1` is defined with the `Netscape_web` resource type, then the resource group containing `ws1` must also contain at least one resource of the type `IP_address` and one resource of the type `volume`. Figure 6-1 shows these dependencies.

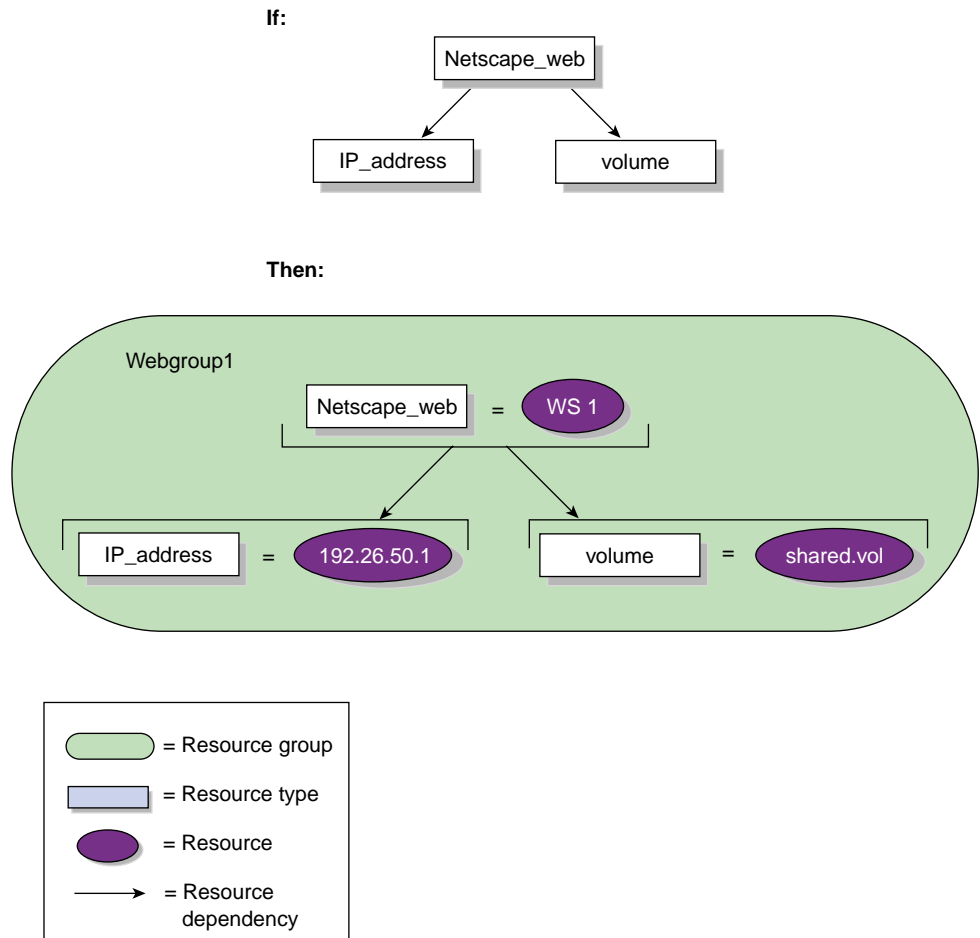

**Figure 6-1** Dependencies

Enter the following information:

1. **Resource Type:** select the resource type.
2. **Dependency Type:** select the dependency type. Click **Add** to add the dependency to the list, click **Delete** to remove the dependency from the list.
3. Click **OK** to complete the task.

**Add/Remove Dependencies for a Resource Type with `cmgr`**

When using `cmgr`, you add or remove dependencies when you define or modify the resource type.

For example, suppose the NFS resource type in `nfs-cluster` has a resource type dependency on `filesystem` resource type. To change the NFS resource type to have a dependency on the `IP_address` resource type instead (and not on `filesystem`), do the following:

```
cmgr> show resource_type NFS in cluster nfs-cluster

Name: NFS
Predefined: true
....

Resource type dependencies
    filesystem

cmgr> modify resource_type NFS in cluster nfs-cluster
Enter commands, when finished enter either "done" or "cancel"

resource_type NFS ? remove dependency filesystem
resource_type NFS ? add dependency IP_address
resource_type NFS ? done
Successfully modified resource_type NFS

cmgr> show resource_type NFS in cluster nfs-cluster

Name: NFS
Predefined: true
....

Resource type dependencies
    IP_address
```

## Load a Resource Type

This section describes how to install (load) a resource type.

### Load a Resource Type with the GUI

When you define a cluster, FailSafe installs a set of resource type definitions that you can use; these definitions include default values. If you need to install additional, standard SGI supplied resource type definitions on the cluster, or if you delete a standard resource type definition and wish to reinstall it, you can load that resource type definition on the cluster.

The resource type definition you are loading cannot already exist on the cluster.

### Load a Resource Type with `cmgr`

Use the following command to install a resource type on a cluster:

```
install resource_type RTname [in cluster Clustername]
```

## Modify a Resource Type Definition

This section describes how to modify a resource type.

### Modify a Resource Type with the GUI

The process of modifying a resource type is similar to the process of defining a resource type.

Enter the following (time values are in milliseconds):

1. **Resource Type:** select the name of the resource type to be modified.  
Click **Next** to move to the next page. The current settings for each field will be filled in for you.
2. **Start/Stop Order:** order of performing the action scripts for resources of this type in relation to resources of other types:
  - Resources are started in the increasing order of this value.
  - Resources are stopped in the decreasing order of this value.

See the *FailSafe Programmer's Guide for SGI Infinite Storage* for a full description of the order ranges available.

3. **Start Timeout:** the maximum duration for starting a resource of this type.
4. **Stop Timeout:** the maximum duration for stopping a resource of this type.
5. **Exclusive Timeout:** the maximum duration for verifying that a resource of this type is not already running.
6. **Monitor Timeout:** the maximum duration for monitoring a resource of this type.
7. **Monitor Interval:** the amount of time between successive executions of the `monitor` action script; this is valid only for the `monitor` action script.
8. **Monitor Start Time:** the amount of time between starting a resource and beginning monitoring of that resource.

Click **Next** to move to the next page.

9. **Enable Restart:** check the box to enable restarting of the resource. You should enable restart if you want a resource of this type to automatically be restarted on the current node after a monitoring failure. Enabling restart can decrease application downtime.

For example, suppose FailSafe detects that a resource's monitor action has failed:

- If restart is disabled, FailSafe will immediately attempt to move the whole group to another node in the failover domain. The application will be down until the entire group is failed over.
- If restart is enabled, FailSafe will attempt to restart the resource on the current node where the rest of the resource group is running. If this succeeds, the resource group will be made available as soon as the resource restarts; if this fails, only then will FailSafe attempt to move the whole group to another node in the failover domain.

The local restart flag enables local failover:

- If local restart is enabled and the resource monitor script fails, SRMD executes the restart script for the resource.
- If the restart script is successful, SRMD continues to monitor the resource.

- If the restart script fails or the restart count is exhausted, SRMD sends a resource group monitoring error to FSD. FSD itself is not involved in local failover.

When a resource is restarted, all other resources in the resource group are not restarted. It is not possible to do a local restart of a resource using the GUI or `cmgr`.

If you find that you need to reset the restart counter for a resource type, you can put the resource group in maintenance mode and remove it from maintenance mode. This process will restart counters for all resources in the resource group. For information on putting a resource group in maintenance mode, see "Suspend and Resume Monitoring of a Resource Group" on page 320.

10. **Restart Timeout:** the maximum amount of time to wait before restarting the resource after a monitoring failure occurs.
11. **Restart Count:** the maximum number of attempts that FailSafe will make to restart a resource of this type on the current node. Enter an integer greater than zero.
12. **Probe Enabled:** check if you want FailSafe to verify that a resource of this type is configured on a node.
13. **Probe Timeout:** the maximum amount of time for FailSafe to attempt to verify that a resource of this type is configured on a node.
14. **Type-Specific Attributes:** specify new attributes that are specific to the resource type, or modify an existing attribute by selecting its name. You must provide the following for each attribute:
  - **Attribute key:** specify the name of the attribute
  - **Data Type:** select either **String** or **Integer**
  - **Default Value:** (*optional*) provide a default value for the attribute

---

**Note:** You cannot modify the type-specific attributes if there are any existing resources of this type.

---

Click **Add** to add the attribute or **Modify** to modify the attribute, and repeat as necessary for other attributes. Click **OK** to complete the definition.

**Modify a Resource Type with `cmgr`**

Use the following commands to modify a resource type:

```
modify resource_type RTname [in cluster Clustername]  
  set order to start/stop_OrderNumber  
  set restart_mode to 0|1  
  set restart_count to Number_Of_Attempts  
  add action ActionScriptname  
    set exec_time to ExecutionTimeout  
    set monitor_interval to MonitorInterval  
    set monitor_time to MonitorTime  
  modify action ActionScriptname  
    set exec_time to ExecutionTimeout  
    set monitor_interval to MonitorInterval  
    set monitor_time to MonitorTime  
  add type_attribute Type-specificAttributename  
    set data_type to string|integer  
    set default_value to Default  
  add dependency RTname  
  remove action ActionScriptname  
  remove type_attribute Type-specific_Attributename  
  remove dependency Dependencyname
```

You modify a resource type using the same commands you use to define a resource type. See "Define a Resource" on page 208.

You can display the current values of the resource type timeouts, allowing you to modify any of the action timeouts.

The following example shows how to increase the `statd_unlimited` resource type monitor executable timeout from 40 seconds to 60 seconds.

```
#cmgr> modify resource_type statd_unlimited in cluster test-cluster  
Enter commands, when finished enter either "done" or "cancel"
```

```
resource_type statd_unlimited? modify action monitor  
Enter action parameters, when finished enter "done" or "cancel"
```

```
Current action monitor parameters:  
  exec_time : 40000ms  
  monitor_interval : 20000ms  
  monitor_time : 50000ms
```



```
Action - monitor ? set exec_time to 60000
Action - monitor ? done
resource_type statd_unlimited ? done
Successfully modified resource_type statd_unlimited
```

The following examples show how to modify the resource type timeouts in prompt mode.

```
#cmgr> modify resource_type statd_unlimited in cluster test-cluster
```

(Enter "cancel" at any time to abort)

```
Node[optional] ?
Order ? (411)
Restart Mode ? (0)
```

MODIFY RESOURCE TYPE OPTIONS

- 0) Modify Action Script.
- 1) Add Action Script.
- 2) Remove Action Script.
- 3) Add Type Specific Attribute.
- 4) Remove Type Specific Attribute.
- 5) Add Dependency.
- 6) Remove Dependency.
- 7) Show Current Information.
- 8) Cancel. (Aborts command)
- 9) Done. (Exits and runs command)

```
Enter option:0
Current resource type actions:
    stop
    exclusive
    start
    restart
    monitor
```

```
Action name ? monitor
Executable timeout (in milliseconds) ? (40000ms) 60000
Monitoring Interval (in milliseconds) ? (20000ms)
```

```
Start Monitoring Time (in milliseconds) ? (50000ms)
```

- 0) Modify Action Script.
- 1) Add Action Script.
- 2) Remove Action Script.
- 3) Add Type Specific Attribute.
- 4) Remove Type Specific Attribute.
- 5) Add Dependency.
- 6) Remove Dependency.
- 7) Show Current Information.
- 8) Cancel. (Aborts command)
- 9) Done. (Exits and runs command)

```
Enter option:9
```

```
Successfully modified resource_type statd_unlimited
```

## Delete a Resource Type

This section describes how to delete a resource type.

### Delete a Resource Type with the GUI

To delete a resource type with the GUI, enter the following:

1. **Resource Type to Delete:** select the name of the resource type that you want to delete.

---

**Note:** If you select a resource type that has been redefined for the local node, that special definition of the resource type will be deleted and the clusterwide resource type will be used instead.

You cannot delete a clusterwide resource type if there are any resources of that type.

---

2. Click **OK** to complete the task.

### Delete a Resource Type with `cmgr`

Use the following command to delete a resource type:

```
delete resource_type RTname [in cluster Clustername]
```

### Display a Resource Type

This section describes how to display resource types.

#### Display Resource Types with the GUI

Select **View: Resource Types**. You can then click on any of the resource type icons in the view area to examine the parameters of the resource type.

#### Display Resource Types with `cmgr`

Use the following commands to view resource types:

1. To view the parameters of a defined resource type (*RTname*):

```
show resource_type RTname [in cluster Clustername]
```

2. To view all of the defined resource types:

```
show resource_types [in cluster Clustername]
```

3. To view all of the defined resource types that have been installed:

```
show resource_types installed
```

## Resource Tasks

A *resource* is a single physical or logical entity that provides a service to clients or other resources. A resource is generally available for use on two or more nodes in a cluster, although only one node controls the resource at any given time. For example, a resource can be a single disk volume, a particular network address, or an application such as a web node.

This section describes the following resource tasks:

- "Define a Resource" on page 208
- "Redefine a Resource for a Specific Node" on page 216

- "Add/Remove Dependencies for a Resource Definition" on page 217
- "Modify a Resource Definition" on page 220
- "Delete a Resource" on page 221
- "Display a Resource" on page 222

## Define a Resource

This section describes how to define a new resource.

### Define a Resource with the GUI

Resources are identified by a *resource type* and a *resource name*. A resource name identifies a specific instance of a resource type. All of the resources in a given resource type can be handled in the same way for the purposes of *failover*.

By default, resources apply clusterwide. However, you can use the **Redefine a Resource for a Specific Node** task to apply the resource to just the local node; see "Redefine a Resource for a Specific Node" on page 216.

Provide appropriate values for the following:

1. **Resource Type:** the name of the resource type.

A resource type can be defined for a specific logical node, or it can be defined for an entire cluster. A resource type that is defined for a node will override a clusterwide resource type definition of the same name; this allows an individual node to override global settings from a clusterwide resource type definition.

The type of resource to define. The FailSafe system includes pre-defined resource types, listed in the GUI. You can define your own resource type as well.

The FailSafe software includes many predefined resource types. If these types fit the application you want to make into an HA service, you can reuse them. If none fit, you can define additional resource types.

2. **Resource:** name of the resource to define, with a maximum length of 255 characters, that does not begin with an underscore. XVM resource names must not begin with a slash (/).

A resource is a single physical or logical entity that provides a service to clients or other resources. Examples include a single disk volume, a particular network HA

IP address, or a specific application such as a web server. Particular resource types may have other naming requirements; see the sections below.

You can define up to 100 resources in a FailSafe configuration.

Click **Next** to move to the next page.

3. **Type-specific attributes:** enter the attributes that apply to this resource. The following sections describe attributes for each resource type provided in the base FailSafe release; other attributes are available with FailSafe plug-in releases and are described in the documentation supplied with those releases. You can specify attributes for new resource types you create.
4. Click **OK** to complete the task.

#### **CXFS Attributes**

The CXFS resource is the mount point of the CXFS filesystem, such as `/shared_CXFS`. In the **Relocate Metadata server?** field, you must specify whether the metadata server of the CXFS filesystem should be relocated (`true`) or not (`false`).

#### **filesystem Attributes**

The `filesystem` resource must be an XFS filesystem.

Any XFS filesystem that must be highly available should be configured as a `filesystem` resource. All XFS filesystems that you use as a `filesystem` resource must be created on XLV volumes on shared disks.

When you define a `filesystem` resource, the name of the resource should be the mount point of the filesystem. For example, an XFS filesystem that was created on an XLV volume `xlv_vol` and mounted on the `/shared1` directory will have the resource name `/shared1`.

Specify the following parameters:

- **Volume Name:** the name of the XLV volume associated with the filesystem. For example, for the filesystem created on the XLV volume `xlv_vol`, the volume name attribute will be `xlv_vol` as well.
- **Mount Options:** the mount options to be used for mounting the filesystem, which are the mount options that have to be passed to the `-o` option of the `mount` command. The list of available options is provided on the `fstab` man page. The default is `rw`.

- **kill-nfsd-before-umount:**
  - `true` stops the `nfsd` NFS server processes in the server before the filesystem is unmounted and then restarts the `nfsd` daemons after the `umount` is completed. This is the default (`true`).
  - `false` unmounts the filesystem without changing the `nfsd` status.
- **Monitoring Level:** the monitoring level to be used for the filesystem.
  - 1 specifies to check whether the filesystem exists in `/etc/mtab`, as described in the `mtab` man page.
  - 2 specifies to check whether the filesystem is mounted using the `stat` command. This is a more-intrusive check that is more reliable if it completes on time; however, some loaded systems have been known to have problems with this level.

#### **IP\_address Attributes**

The `IP_address` resources are the IP addresses used by clients to access the HA services within the resource group. These HA IP addresses are moved from one node to another along with the other resources in the resource group when a failure is detected.

You specify the resource name of an `IP_address` resource in dot (".") notation. IP names that require name resolution should not be used. For example, `192.26.50.1` is a valid resource name of the `IP_address` resource type.

The HA IP address you define as a FailSafe resource must not be the same as the IP address of a node hostname or the IP address of a node's control network.

Specify the following parameters:

- **Network Mask:** the network mask of the HA IP address.
- **Interfaces:** a comma-separated list of interfaces on which the HA IP address can be configured. This ordered list is a superset of all the interfaces on all nodes where this HA IP address might be allocated. You can specify multiple interfaces to configure local restart of the HA IP address, if those interfaces are on the same node. However, using local IP failover requires that you make changes to the `start` and `restart` action scripts for the `IP_address` resource; see "Example: Local Failover of HA IP Address" on page 279.

The order of the list of interfaces determines the priority order for determining which HA IP address will be used for local restarts of the node.

- **Broadcast Address:** the broadcast address for the HA IP address

#### **MAC\_address Attributes**

The MAC address is the link-level address of the network interface. If MAC addresses are to be failed over, dedicated network interfaces are required.

The resource name of a MAC address is the MAC address of the interface. You can obtain MAC addresses by using the `ha_macconfig2` command.

You must specify attribute **Interface:**, which is the interface that has to be reMAC-ed.

Only Ethernet interfaces are capable of undergoing the reMAC process.

#### **volume Attributes**

The `volume` resource type is the XLV volume used by the resources in the resource group.

When you define a `volume` resource, the resource name should be the name of the XLV volume. Do not specify the XLV device file name as the resource name. For example, the resource name for a volume might be `xl_vol` but not `/dev/xlv/xlv_vol` or `/dev/dsk/xlv/xlv_vol`.

When an XLV volume is assembled on a node, a file is created in `/dev/xlv`. Even when you configure a volume resource in a FailSafe cluster, you can view that volume from only one node at a time, unless a failover has occurred.

You may be able to view a volume name in `/dev/xlv` on two different nodes after failover because when an XLV volume is shut down, the filename is not removed from that directory. Hence, more than one node may have the volume filename in its directory. However, only one node at a time will have the volume assembled. Use `xl_vmgr` to see which machine has the volume assembled.

Specify the following parameters:

- **Device Group:** the group name of the XLV device file. The `sys` group is the default group name for XLV device files.
- **Device Owner:** the user name (login name) of the owner of the XLV device file. `root` is the default owner for XLV device files.
- **Device Mode:** the device file permissions, specified in octal notation. `600` mode is the default value for XLV device file permissions.

#### **xvm Attributes**

The `xvm` resource type is the local XVM volume used by FailSafe applications.

When you define an `xvm` resource, the resource name must be a unique string for all local XVM domains in the FailSafe cluster. The name should be the name of the volume without the preceding `vol/` characters.

Specify the following parameters:

- **FS XVM owner:** is the XVM temporary owner for FailSafe. This value must not be the cluster name or a hostname known to any machine in the cluster. The default is `fake_owner`.
- **Device group:** is the XVM device group. The default is `sys`.
- **Physvol names:** the names of the physical volume that comprise an XVM volume, separated by commas (spaces are not accepted). This name does not contain the `vol/` prefix that is displayed by the `xvm` command. (For example, if you enter `bigvol` here, the `xvm show` command would display this physvol as `vol/bigvol`.) You must enter a value in this field, there is no default.
- **Device mode:** is the XVM device mode permissions. The default is `600`.
- **Device owner:** is the XVM device owner. The default is `root`.

For more details about XVM, see the *XVM Volume Manager Administrator's Guide*.



**Define a Resource with cmgr**

Use the following command to define a clusterwide resource:

```
define resource Resourcename [of resource_type RTname] [in cluster Clustername]
  set Key to AttributeValue
  add dependency Dependencyname of type RTname
  remove dependency Dependencyname of type RTname
```

Usage notes:

- The resource name has a maximum length of 255 characters and cannot begin with an underscore. XVM resource names must not begin with a slash (/).
- set *Key* specifies the name of the attribute, and *AttributeValue* sets its value
- add dependency adds a dependency of the specified resource type (*RTname*)
- remove dependency deletes a dependency of the specified resource type

When you use this command to define a resource, you define a clusterwide resource that is not specific to a node.

The legal values for set *Key* to *AttributeValue* will depend on the type of resource you are defining, as described in "Define a Resource" on page 208. For detailed information on how to determine the format for defining resource attributes, see "Specify Resource Attributes with cmgr" on page 214.

When you are finished defining the resource and its dependencies, enter done to return to the cmgr prompt.

For example:

```
cmgr> define resource /hafsl/nfs/statmon of resource_type statd_unlimited in cluster nfs-cluster
resource /hafsl/nfs/statmon? set ExportPoint to /hafsl/subdir
resource /hafsl/nfs/statmon? done
```

The following section of a cmgr script defines a resource of resource type statd\_unlimited:

```
define resource /hafsl/nfs/statmon of resource_type statd_unlimited in cluster nfs-cluster
  set ExportPoint to /hafsl/subdir
done
```

**Specify Resource Attributes with `cmgr`**

To see the format in which you can specify the user-specific attributes that you must set for a particular resource type, you can enter the following command to see the full definition of that resource type:

```
show resource_type RTname [in cluster Clustername]
```

For example, to see the attributes you define for a resource of resource type `volumes`, enter the following command:

```
cmgr> show resource_type volume in cluster test-cluster
```

At the bottom of the resulting display, the following appears:

```
Type specific attribute: devname-group
    Data type: string
    Default value: sys
Type specific attribute: devname-owner
    Data type: string
    Default value: root
Type specific attribute: devname-mode
    Data type: string
    Default value: 600
```

This display reflects the format in which you can specify the group ID, the device owner, and the device file permissions for the volume:

- `devname-group` specifies the group ID of the XLV device file
- `devname_owner` specifies the owner of the XLV device file
- `devname_mode` specifies the device file permissions

For example, to set the group ID to `sys` for a resource name `A`, enter the following command:

```
resource A? set devname-group to sys
```

Table 6-2 summarizes the attributes you specify for the predefined FailSafe resource types with the `set Key to AttributeValue` command.

**Table 6-2** Resource Type Attributes

Resource Type	Attribute	Description
CXFS	relocate-mds	Specifies if the metadata server of the CXFS filesystem should be relocated or not. (The name of a CXFS resource is the mount point of the CXFS filesystem. For example, /shared_CXFS.)
filesystem	volume-name	Specifies the name of the xlv volume associated with the filesystem.
	mount-options	Specifies the mount options to be used for mounting the filesystem.
	kill-nfsds-before-umount	When set to <code>true</code> , stops the <code>nfsd</code> NFS server processes running in the server before the filesystem is unmounted and then restarts <code>nfsd</code> after the <code>umount</code> is completed. When set to <code>false</code> , the <code>umount</code> takes place without changing the <code>nfsd</code> status. The default is <code>true</code> .
	monitoring-level	Specifies the monitoring level to be used for the filesystem: <ul style="list-style-type: none"> <li>• 1 specifies to check whether the filesystem exists in <code>/etc/mtab</code>, as described in the <code>mtab</code> man page.</li> <li>• 2 specifies to check whether the filesystem is mounted using the <code>stat</code> command. This is a more-intrusive check that is more reliable if it completes on time; however, some loaded systems have been known to have problems with this level.</li> </ul>
IP_address	NetworkMask	Specifies the subnet mask of the IP address.
	interfaces	Specifies a comma-separated list of interfaces on which the IP address can be configured.
	BroadcastAddress	Specifies the broadcast address for the IP address.
MAC_address	interface-name	Specifies the name of the interface that has to be re-MACed.
volume	devname-group	Specifies the group ID of the xlv device file.
	devname_owner	Specifies the owner of the xlv device.
	devname_mode	Specifies device file permissions.

Resource Type	Attribute	Description
XVM	<code>fs_xvm_owner</code>	Specifies the XVM temporary owner for FailSafe. This value must not be the cluster name or a hostname known to any node in the cluster. The default is <code>fake_owner</code> .
	<code>devname_group</code>	Specifies the XVM device group. The default is <code>sys</code> .
	<code>physvol_names</code>	Specifies the names of the physical volumes, separated by commas. There is no default.
	<code>devname_mode</code>	Specifies the permission mode of the XVM device in octal. The default is <code>600</code> .
	<code>devname_owner</code>	Specifies the XVM device owner. The default is <code>root</code> .

### Redefine a Resource for a Specific Node

This section describes redefining a resource for a specific node. You must connect the GUI or execute the `cmgr` command on the node for which the resource type will be redefined.

#### Redefine a Resource for a Specific Node with the GUI

You can redefine an existing resource for a specific node from that node (the local node) only. Only existing clusterwide resources can be redefined.

You may want to use this feature when you configure heterogeneous clusters for an `IP_address` resource. For example, the resource `192.26.50.2` of type `IP_address` can be configured on a Gigabit Ethernet interface `eg0` on a server and on a 100BASE-T interface `ef0` on another server. The clusterwide resource definition for `192.26.50.2` will have the `interfaces` field set to `ef0` and the node-specific definition for the first node will have `eg0` as the `interfaces` field.

Provide appropriate values for the following:

1. **Local Node:** the name of the node on which the GUI is currently running, which is provided for you. You can only redefine a resource for this node. To redefine a resource for a different node, you must connect the GUI to that node.



---

**Caution:** You should only make changes from one instance of the GUI at any given time in the cluster. Changes made by a second GUI instance — a second invocation of `fsmgr` — may overwrite changes made by the first instance, because different GUI instances are updated independently at different times. (In time, however, independent GUI instances will provide the same information.) However, multiple windows accessed via the **File** menu are all part of a single GUI instance; you can make changes from any of these windows.

---

2. **Resource Type:** select the resource type.
3. **Clusterwide Resource:** name of the resource that you want to redefined for this node. Click **Next** to move to the next page.
4. **Type-specific attributes:** change the information for each attribute as needed. For information about each attribute, see "Define a Resource with the GUI" on page 208.
5. Click **OK** to complete the task.

### Redefine a Resource for a Specific Node with `cmgr`

You can use `cmgr` to redefine a clusterwide resource to be specific to a node just as you define a clusterwide resource, except that you specify a node on the `define resource` command. You must execute the `cmgr` command on the node for which the resource will be redefined.

Use the following command to define a node-specific resource:

```
define resource Resourcename of resource_type RTname on node Nodename [in cluster Clustername]
```

If you have already specified a default cluster, you do not need to specify a cluster in this command because `cmgr` will use the default.

### Add/Remove Dependencies for a Resource Definition

This section describes how to add and remove dependencies for a resource.

### Add/Remove Dependencies for a Resource Definition with the GUI

A resource can be dependent on one or more other resources; if so, it will not be able to start (that is, be made available for use) unless the dependent resources are started as well. Dependent resources must be part of the same resource group.

As you define resources, you can define which resources are dependent on other resources. For example, a web server may depend on a both an HA IP address and a filesystem. In turn, a filesystem may depend on a volume. This is shown in Figure 6-2.

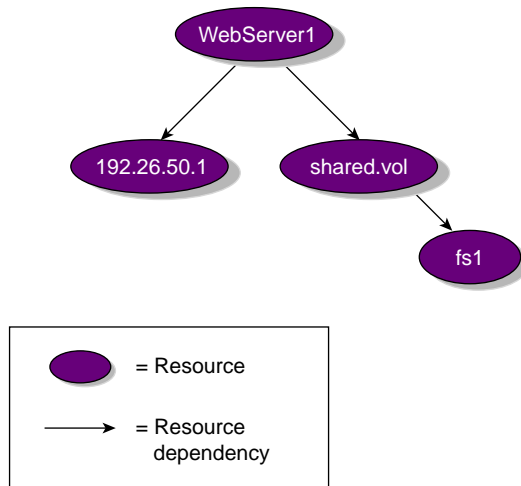

**Figure 6-2** Example of Resource Dependency

You cannot make resources mutually dependent. For example, if resource A is dependent on resource B, then you cannot make resource B dependent on resource A. In addition, you cannot define cyclic dependencies. For example, if resource A is dependent on resource B, and resource B is dependent on resource C, then resource C cannot be dependent on resource A. This is shown in Figure 6-3.

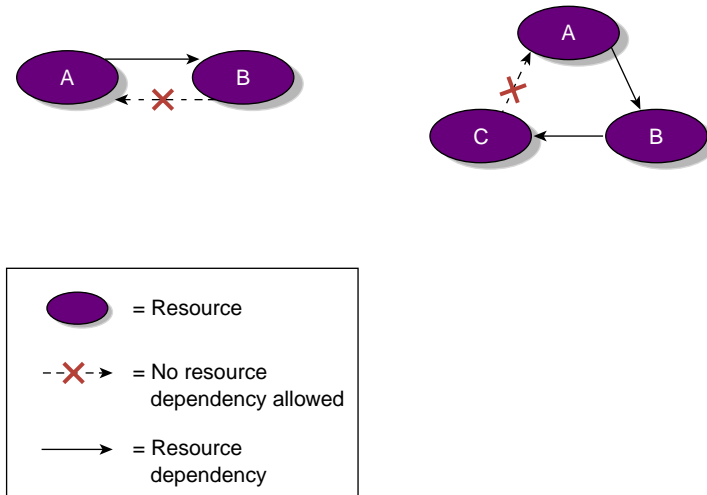

**Figure 6-3** Mutual Dependency of Resources Is Not Allowed

Provide appropriate values for the following:

1. **Resource Type:** select the name of the resource type.
2. **Resource:** select the resource name.
3. **Dependency Type:** select the resource type to be added to or deleted from the dependency list.
4. **Dependency Name:** select the resource name to be added to or deleted from the dependency list. Click **Add** to add the displayed type and name to the list.
5. Click **OK** to complete the task.

#### Add/Remove Dependencies for a Resource Definition with `cmgr`

To add or remove dependencies for a resource definition, use the `modify resource` command. For example:

```
cmgr> modify resource /hafs1/expdir of resource_type NFS in cluster nfs-cluster
Enter commands, when finished enter either "done" or "cancel"
```

Type specific attributes to modify with `set` command:

Type Specific Attribute - 1: export-info

Type Specific Attribute - 2: filesystem

Resource type dependencies to add or remove:

Resource dependency - 1: /hafs1            type: filesystem

```
resource /hafs1/expdir ? add dependency 100.102.10.101 of type IP_address
```

```
resource /hafs1/expdir ? done
```

```
Successfully modified resource /hafs1/expdir
```

## Modify a Resource Definition

This section describes how to modify a resource definition.

### Modify a Resource Definition with the GUI

You can modify only the type-specific attributes for a resource. You cannot rename a resource after it has been defined; to rename a resource, you must delete it and define the new resource.

Provide appropriate values for the following:

1. **Resource Type:** select the name of the resource type.
2. **Resource:** select the name of resource to be modified. Click **Next** to move to the next page.
3. **Type-specific attributes:** modify the attributes as needed. For information about attributes, see "Define a Resource with the GUI" on page 208.
4. Click **OK** to complete the task.

---

**Note:** There are some resource attributes whose modification does not take effect until the resource group containing that resource is brought online again. For example, if you modify the export options of a resource of type NFS, the modifications do not take effect immediately; they take effect when the resource is brought online.

---



### Modify a Resource Definition with `cmgr`

Use the following commands to modify a resource:

```
modify resource Resourcename [of resource_type RTname] on node Nodename [in cluster Clustername]
```

```
modify resource Resourcename [of resource_type RTname] [in cluster Clustername]  
  set key to AttributeValue  
  add dependency dependencyname of type typename  
  remove dependency dependencyname of type typename
```

You modify a resource using the same commands you use to define a resource. See "Define a Resource" on page 208.

### Delete a Resource

This section describes how to delete a resource.

#### Delete a Resource with the GUI

A resource may not be deleted if it is part of a resource group. See "Add/Remove Resources in Resource Group" on page 237.

To delete a resource, provide the following:

1. **Resource Type:** select the resource type.
2. **Resource to Delete:** select the name of the resource to be deleted.
3. Click **OK** to complete the task.

If you select a resource that has been redefined for the node to which the GUI is connected, the delete operation will delete the redefined resource definition and also put into effect the clusterwide resource definition.

If you select a clusterwide resource definition, the delete operation will delete this definition and make it unavailable for use in a resource group. Deleting a clusterwide resource definition will fail if the resource is part of any resource group.

### Delete a Resource with `cmgr`

Use the following command to delete a resource definition:

```
delete resource Resourcename of resource_type RTtype [in cluster Clustername]
```

### Display a Resource

You can display the following:

- Attributes of a particular defined resource
- All of the defined resources in a specified resource group
- All the defined resources of a specified resource type



**Caution:** Anyone can use the GUI to view database information; therefore, you should not include any sensitive information in the cluster database.

---

### Display a Resource with the GUI

The GUI provides a convenient display of resources through the view area. Select **View: Resources in Groups** to see all defined resources. The status of these resources will be shown in the icon (grey indicates offline). Alternately, you can select **View: Resources by Type** or **View: Resources owned by Nodes**.

### Display a Resource with `cmgr`

Use the following commands to display a resource:

- To view the parameters of a single resource:

```
show resource Resourcename of resource_type RTname
```

- To view all of the defined resources in a resource group:

```
show resources in resource_group RGname [in cluster Clustername]
```

- To view all of the defined resources of a particular resource type in a specified cluster:

```
show resources of resource_type RTname [in cluster Clustername]
```

## Failover Policy Tasks

A *failover policy* is the method used by FailSafe to determine the destination node of a failover. A failover policy consists of the following:

- Failover domain
- Failover attributes
- Failover script

FailSafe uses the failover domain output from a failover script along with failover attributes to determine on which node a resource group should reside.

The administrator must configure a failover policy for each resource group. A failover policy name must be unique within the pool.

This section describes the following failover policy tasks:

- "Define a Failover Policy"
- "Modify a Failover Policy Definition" on page 229
- "Delete a Failover Policy" on page 232
- "Display a Failover Policy" on page 233

## Define a Failover Policy

This section describes how to define a failover policy.

### Define a Failover Policy with the GUI

Before you can configure your resources into a resource group, you must determine which failover policy to apply to the resource group. To define a failover policy, provide the following information:

1. **Failover Policy:** enter the name of the failover policy, with a maximum length of 63 characters, which must be unique within the pool.
2. **Script:** select the name of an existing failover script. The failover script generates the run-time failover domain and returns it to the FailSafe process. The FailSafe process applies the failover attributes and then selects the first node in the returned failover domain that is also in the current FailSafe membership:

- `ordered` never changes the initial failover domain; when using this script, the initial and run-time failover domains are equivalent.
- `round-robin` selects the resource group owner in a round-robin (circular) fashion. This policy can be used for resource groups that can be run in any node in the cluster.

Failover scripts are stored in the `/var/clusters/ha/policies` directory. If the scripts provided with the release do not meet your needs, you can define a new failover script and place it in the `/var/clusters/ha/policies` directory. When you are using the FailSafe GUI, the GUI automatically detects your script and presents it to you as a choice. You can configure the cluster database to use your new failover script for the required resource groups. For information on defining failover scripts, see the *FailSafe Programmer's Guide for SGI Infinite Storage*.

3. **Failback:** choose the name of the *failover attribute*, which is a value that is passed to the failover script and used by FailSafe for the purpose of modifying the run-time failover domain used for a specific resource group.

You can specify the following classes of failover attributes:

- Required attributes: either `Auto_Failback` or `Controlled_Failback` (mutually exclusive)
- Optional attributes:
  - `Auto_Recovery` or `InPlace_Recovery` (mutually exclusive)
  - `Critical_RG`
  - `Node_Failures_Only`

---

**Note:** The starting conditions for the attributes differ by class:

- For required attributes, a node joins the FailSafe membership when the cluster is already providing HA services.
  - For optional attributes, HA services are started and the resource group is running in only one node in the cluster.
- 

Table 6-3 describes each attribute.

**Table 6-3** Failover Attributes

Class	Name	Description
Required	Auto_Failback	Specifies that the resource group is made online based on the failover policy when the node joins the cluster. This attribute is best used when some type of load balancing is required. You must specify either this attribute or the Controlled_Failback attribute.
	Controlled_Failback	Specifies that the resource group remains on the same node when a node joins the cluster. This attribute is best used when client/server applications have expensive recovery mechanisms, such as databases or any application that uses tcp to communicate. You must specify either this attribute or the Auto_Failback attribute.
Optional	Auto_Recovery	Specifies that the resource group is made online based on the failover policy even when an exclusivity check shows that the resource group is running on a node. This attribute is optional and is mutually exclusive with the InPlace_Recovery attribute. If you specify neither of these attributes, FailSafe will use this attribute by default if you have specified the Auto_Failback attribute.
	InPlace_Recovery	Specifies that the resource group is made online on the same node where the resource group is running. This attribute is optional and is mutually exclusive with the Auto_Recovery attribute. If you specify neither of these attributes, FailSafe will use this attribute by default if you have specified the Controlled_Failback attribute.

Class	Name	Description
	Critical_RG	Allows monitor failure recovery to succeed even when there are resource group release failures. When resource monitoring fails, FailSafe attempts to move the resource group to another node in the application failover domain. If FailSafe fails to release the resources in the resource group, FailSafe puts the resource group into <code>srmd executable error</code> status. If the <code>Critical_RG</code> failover attribute is specified in the failover policy of the resource group, FailSafe will reset the node where the release operation failed and move the resource group to another node based on the failover policy.
	Node_Failures_Only	Allows failover only when there are node failures. This attribute does not have an impact on resource restarts in the local node. The failover does not occur when there is a resource monitoring failure in the resource group. This attribute is useful for customers who are using a hierarchical storage management system such as DMF; in this situation, a customer may want to have resource monitoring failures reported without automatic recovery, allowing operators to perform the recovery action manually if necessary.

See the *FailSafe Programmer's Guide for SGI Infinite Storage* for a full discussion of example failover policies.

4. **Recovery:** choose the recovery attribute:
  - **Let FailSafe Choose** means that FailSafe will determine the best attribute for the circumstances.
  - **Automatic** means that the group will be brought online on the initial node in the failover domain.
  - **In Place** means that the group will be brought online on the node where the group is already partially allocated.
5. **Critical Resource Group:** check to toggle selection. Selecting this attribute allows monitor failure recovery to succeed even when there are resource group release failures.

When resource monitoring fails, FailSafe attempts to move the resource group to another node in the failover domain:

- If FailSafe fails to release the resources, it puts the resource group into `srmd executable error` state.
  - If you select the **Critical Resource Group** state, FailSafe will reset the node where the release operation failed and move the resource group to another node based on the failover policy.
6. **Node Failures Only:** this attribute controls failover on resource monitoring failures. If you select this attribute, the resource group recovery (that is, failover to another node in the failover domain) is performed only when there are node failures.
  7. **Other Attributes:** enter in additional attributes to be used for failover. These optional attributes are determined by the user-defined failover scripts that you can write and place into the `/var/cluster/ha/policies` directory.
  8. **Ordered Nodes in Failover Domain:** a *failover domain* is the ordered list of nodes on which a given resource group can be allocated. The nodes listed in the failover domain **must** be defined for the cluster; however, the failover domain does not have to include every node in the cluster. The failover domain can be also used to statically load-balance the resource groups in a cluster.

Examples:

- In a four-node cluster, a set of two nodes that have access to a particular XLV volume should be the failover domain of the resource group containing that XLV volume.
- In a cluster of nodes named `venus`, `mercury`, and `pluto`, you could configure the following initial failover domains for resource groups `RG1` and `RG2`:
  - `RG1: mercury, venus, pluto`
  - `RG2: pluto, mercury`

The administrator defines the *initial failover domain* when configuring a failover policy. The initial failover domain is used when a cluster is first booted. The ordered list specified by the initial failover domain is transformed into a *run-time failover domain* by the failover script. With each failure, the failover script takes the current run-time failover domain and potentially modifies it (for the ordered failover script, the order will not change); the initial failover domain is never used

again. Depending on the run-time conditions, such as load and contents of the failover script, the initial and run-time failover domains may be identical.

For example, suppose that the cluster contains three nodes named N1, N2, and N3; that node failure is not the reason for failover; and that the initial failover domain is as follows:

```
N1 N2 N3
```

The run-time failover domain will vary based on the failover script:

- If ordered:

```
N1 N2 N3
```

- If round-robin:

```
N2 N3 N1
```

- If a customized failover script, the order could be any permutation, based on the contents of the script:

```
N1 N2 N3          N1 N3 N2
N2 N1 N3          N2 N3 N1
N3 N1 N2          N3 N2 N1
```

FailSafe stores the run-time failover domain and uses it as input to the next failover script invocation.

9. Click **OK** to complete the task.

Complete information on failover policies and failover scripts, with an emphasis on writing your own failover policies and scripts, is provided in the *FailSafe Programmer's Guide for SGI Infinite Storage*.

### Define a Failover Policy with `cmgr`

For details about failover policies, see "Define a Failover Policy with the GUI" on page 223.

Use the following to define a failover policy:

```
define failover_policy Polycyname
  set attribute to Attributename
  set script to Scriptname
  set domain to Nodename
```



The following prompt appears:

```
failover_policy Policyname?
```

When you define a failover policy, you can set as many attributes and domains as your setup requires, executing the `add attribute` and `add domain` commands with different values. You can also specify multiple domains in one command of the following format:

```
set domain to Node1 Node2 Node3 ...
```

The components of a failover policy are described in detail in the *FailSafe Programmer's Guide for SGI Infinite Storage* and in summary in "Define a Failover Policy with the GUI" on page 223.

For example, suppose you have a failover policy named `fp_ord` with attributes `Auto_Failback`, `Auto_Recovery` and `Critical_RG` and a failover domain of `node2 node1`. The primary node is `node2` and the backup node is `node1`. Following is an example of defining the failover policy in normal mode:

```
cmgr> define failover_policy fp_ord
Enter commands, when finished enter either "done" or "cancel"

failover_policy fp_ord? set attribute to Auto_Failback
failover_policy fp_ord? set attribute to Auto_Recovery
failover_policy fp_ord? set attribute to Critical_RG
failover_policy fp_ord? set script to ordered
failover_policy fp_ord? set domain to node2 node1
failover_policy fp_ord? done
```

## Modify a Failover Policy Definition

This section describes how to modify a failover policy.

### Modify a Failover Policy Definition with the GUI

The process of deleting a failover policy is similar to defining a new policy. See "Define a Failover Policy with the GUI" on page 223.

Do the following:

1. **Failover Policy:** select the name of the failover policy.

2. **Script:** use the menu to select the name of an existing failover script:
  - `ordered` never changes the initial domain; when using this script, the initial and run-time domains are equivalent.
  - `round-robin` selects the resource group owner in a round-robin (circular) fashion. This policy can be used for resource groups that can be run in any node in the cluster.

Failover scripts are stored in the `/var/clusters/ha/policies` directory. If the scripts provided with the release do not meet your needs, you can define a new failover script and place it in the `/var/clusters/ha/policies` directory. When you are using the FailSafe GUI, the GUI automatically detects your script and presents it to you as a choice. You can configure the cluster database to use your new failover script for the required resource groups. For information on defining failover scripts, see the *FailSafe Programmer's Guide for SGI Infinite Storage*.

3. **Failback:** choose the name of the failover attribute. You can specify the following classes of failover attributes:
  - Required attributes: either `Auto_Failback` or `Controlled_Failback` (mutually exclusive)
  - Optional attributes:
    - `Auto_Recovery` or `InPlace_Recovery` (mutually exclusive)
    - `Critical_RG`
    - `Node_Failures_Only`

---

**Note:** The starting conditions for the attributes differs by class:

- For required attributes, a node joins the FailSafe membership when the cluster is already providing HA services.
  - For optional attributes, HA services are started and the resource group is running in only one node in the cluster.
- 

Table 6-3 on page 225 describes each attribute.

See the *FailSafe Programmer's Guide for SGI Infinite Storage* for a full discussions of example failover policies.

4. **Recovery:** choose the recovery attribute, or let Failsafe choose the best attribute for the circumstances:
  - `Automatic` means that the group will be brought online on the initial node in the failover domain.
  - `InPlace` means that the group will be brought online on the node where the group is already partially allocated.
5. **Critical Resource Group:** check to toggle selection. Selecting this attribute allows monitor failure recovery to succeed even when there are resource group release failures.

When resource monitoring fails, FailSafe attempts to move the resource group to another node in the failover domain:

- If FailSafe fails to release the resources, it puts the resource group into `srmcd executable error` state.
  - If you select the **Critical Resource Group** state, FailSafe will reset the node where the release operation fails and move the resource group to another node based on the failover policy.
6. **Node Failures Only:** this attribute controls failover on resource monitoring failures. If you select this attribute, the resource group recovery (that is, failover to another node in the failover domain) is performed only when there are node failures.
  7. **Other Attributes:** enter in additional attributes to be used for failover. These optional attributes are determined by the user-defined failover scripts that you can write and place into the `/var/cluster/ha/policies` directory.
  8. **Ordered Nodes in Failover Domain:** a *failover domain* is the ordered list of nodes on which a given resource group can be allocated. The nodes listed in the failover domain **must** be defined for the cluster; however, the failover domain does not have to include every node in the cluster. The failover domain also can be used to statically load-balance the resource groups in a cluster.

The administrator defines the *initial failover domain* when configuring a failover policy. The initial failover domain is used when a cluster is first booted. The ordered list specified by the initial failover domain is transformed into a *run-time failover domain* by the failover script. With each failure, the failover script takes the current run-time failover domain and potentially modifies it (for the *ordered* failover script, the order will not change); the initial failover domain is never used

again. Depending on the run-time conditions, such as load and contents of the failover script, the initial and run-time failover domains may be identical.

FailSafe stores the run-time failover domain and uses it as input to the next failover script invocation.

9. Click **OK** to complete the task.

Complete information on failover policies and failover scripts, with an emphasis on writing your own failover policies and scripts, is provided in the *FailSafe Programmer's Guide for SGI Infinite Storage*.

### Modify a Failover Policy Definition with `cmgr`

Use the following command to modify a failover policy:

```
modify failover_policy Policyname
```

You modify a failover policy using the same commands you use to define a failover policy. See "Define a Failover Policy with `cmgr`" on page 228.

### Delete a Failover Policy

This section describes how to delete a failover policy.

#### Delete a Failover Policy with the GUI

This task lets you delete a failover policy. Deleting a failover policy does not delete the cluster nodes in the policy's failover domain.

---

**Note:** You cannot delete a failover policy that is currently being used by a resource group. You must first use the **Modify Resource Group** task to select a different failover policy for the resource group.

---

Do the following:

1. **Failover Policy to Delete:** select a policy.
2. Click **OK** to complete the task.

### Delete a Failover Policy with `cmgr`

Use the following command to delete a failover policy:

```
delete failover_policy Polycyname
```

### Display a Failover Policy

You can use FailSafe to display any of the following:

- The components of a specified failover policy
- All of the failover policies
- All of the failover policy attributes
- All of the failover policy scripts

### Display a Failover Policy with the GUI

Select **View: Failover Policies** to see all defined failover policies in the view area. Select the name of a specific policy in the view area in order to see details about it in the details area.

### Display a Failover Policy with `cmgr`

Use the following commands to display a failover policy:

- To view all of the failover policies:  

```
show failover policies
```
- To view the parameters of a specific failover policy:  

```
show failover_policy Polycyname
```
- To view all of the failover policy attributes:  

```
show failover_policy attributes
```
- To view all of the failover policy scripts:  

```
show failover_policy scripts
```

## Resource Group Tasks

A *resource group* is a collection of interdependent resources. A resource group is identified by a simple name; this name must be unique within a cluster.

This section describes the following resource group tasks:

- "Define a Resource Group"
- "Modify a Resource Group Definition" on page 236
- "Delete a Resource Group" on page 236
- "Add/Remove Resources in Resource Group" on page 237
- "Display a Resource Group" on page 238

### Define a Resource Group

This section describes how to define a resource group.

#### Define a Resource Group with the GUI

Resources are configured together into *resource groups*. A resource group is a collection of interdependent resources. If any individual resource in a resource group becomes unavailable for its intended use, then the entire resource group is considered unavailable. Therefore, a resource group is the unit of failover for FailSafe.

For example, a resource group could contain all of the resources that are required for the operation of a web node, such as the web node itself, the HA IP address with which it communicates to the outside world, and the disk volumes containing the content that it serves.

When you define a resource group, you specify a *failover policy*. A failover policy controls the behavior of a resource group in failure situations.

Do the following:

1. **Failover Policy:** select the name of the failover policy. This policy will determine which node will take over the services of the resource group upon failure.
2. **Resource Group Name:** enter the name of the resource group, with a maximum length of 63 characters.
3. Click **OK** to complete the task.

To add resources to the group, see "Add/Remove Resources in Resource Group" on page 237.

---

**Note:** FailSafe does not allow resource groups that do not contain any resources to be brought online.

---

You can define up to 100 resources configured in any number of resource groups.

### Define a Resource Group with `cmgr`

Use the following command to define a resource group:

```
define resource_group RGname [in cluster Clustername]  
    set failover_policy to Policyname  
    add resource Resourcename of resource_type RTname  
    remove resource Resourcename of resource_type RTname
```

Usage notes:

- `failover_policy` specifies the failover policy name
- `resource` specifies the resource name
- `resource_type` specifies the resource type

For example:

```
cmgr> define resource_group group1 in cluster filesystem-cluster  
Enter commands, when finished enter either "done" or "cancel"  
  
resource_group group1? failover_policy to fp_ord  
resource_group group1? add resource 10.154.99.99 of resource_type IP_address  
resource_group group1? add resource havol of resource_type volume  
resource_group group1? add resource /hafs of resource_type filesystem  
resource_group group1? done
```

For a full example of resource group creation using `cmgr` see "Example: Create a Resource Group" on page 278.

## Modify a Resource Group Definition

This section describes how to modify a resource group.

### Modify a Resource Group Definition with the GUI

This task lets you change a resource group by changing its failover policy.

Do the following:

1. **Resource Group:** select a resource group
2. **Failover Policy:** select a failover policy
3. Click **OK** to complete the task

To change the contents of the resource group, see "Add/Remove Resources in Resource Group" on page 237.

### Modify a Resource Group Definition with `cmgr`

Use the following commands to modify a resource group:

```
modify resource_group RGname [in cluster Clustername]  
    set failover_policy to Policyname  
    add resource Resourcename of resource_type RTname  
    remove resource Resourcename of resource_type RTname
```

For example:

```
cmgr> modify resource_group WS1 in cluster test-cluster
```

You modify a resource group using the same commands you use to define a resource group. See "Define a Resource Group with `cmgr`" on page 235.

## Delete a Resource Group

This section describes how to delete a resource group.



### Delete a Resource Group with the GUI

This task lets you delete an offline resource group. Deleting the group does not delete the individual resources that are members of the group.

---

**Note:** You cannot delete a resource group that is online.

---

Do the following:

1. **Resource Group:** select the name of the resource group you want to delete. Only offline resource groups are listed.
2. Click **OK** to complete the task.

### Delete a Resource Group with `cmgr`

Use the following command to delete a resource group:

```
delete resource_group RGname [in cluster Clustername]
```

For example:

```
cmgr> delete resource_group WS1 in cluster test-cluster
```

### Add/Remove Resources in Resource Group

This task lets you change a resource group by adding or removing resources.

---

**Note:** You cannot have a resource group online that does not contain any resources; therefore, FailSafe does not allow you to delete all resources from a resource group after the resource group is online. Likewise, FailSafe does not allow you to bring a resource group online if it has no resources.

---

Resources must be added and deleted in atomic units; this means that resources that are interdependent must be added and deleted together.

---

**Note:** All interdependent resources must be added to the same resource group.

---

Do the following:

1. **Resource Group:** select a resource group. A list of existing resources in the group appears.
2. To add a resource to the group:
  - **Resource Type:** select a resource type
  - **Resource Name:** select a resource name
  - Click **Add**
3. To modify a resource in the group:
  - Select its name from the display window
  - Click **Modify**
4. To delete a resource from the group:
  - Select its name from the display window
  - Click **Delete**
5. Click **OK** to complete the task.

## Display a Resource Group

This section describes how to display a resource group.

### Display a Resource Group with the GUI

You can display the parameters of a defined resource group, and you can display all of the resource groups defined for a cluster.

## Display a Resource Group with `cmgr`

Use the following commands to display a resource group

- To view a specific resource group:

```
show resource_group RGname [in cluster Clustername]
```

For example:

```
cmgr> show resource_group small-rg in cluster test-cluster
```

```
Resource Group: small-rg
Cluster: test-cluster
Failover Policy: test_fp
```

```
Resources:
  100.101.10.101 (type: IP_address)
  /hafs (type: filesystem)
  havol (type: volume)
```

- To view all of the resource groups:

```
show resource_groups [in cluster Clustername]
```

For example:

```
cmgr> show resource_groups in cluster test-cluster
```

```
Resource Groups:
  bar-rg
  foo-rg
  small-rg
```

## FailSafe HA Services Tasks

After you have configured your FailSafe system and run diagnostic tests on its components, you can activate FailSafe by starting the highly available (HA) services. You can start HA services on all of the nodes in a cluster or on a specified node only.

This section describes the following tasks:

- "Start FailSafe HA Services"
- "Stop FailSafe HA Services" on page 241
- "Set FailSafe HA Parameters" on page 244

- "Set Log Configuration" on page 246

## Start FailSafe HA Services

This section describes how to start FailSafe HA services.

### Start FailSafe HA Services with the GUI

You can start FailSafe HA services on all of the nodes in a cluster or on a specified node only:

1. **Cluster Name:** the name of the cluster is specified for you.
2. **One Node Only:** if you want HA services to be started on one node only, choose its name. If you leave this field blank, HA services will be started on every node in the cluster.



**Caution:** When you start HA services on a subset of nodes, you should ensure that resource groups are running on only the started nodes. For example, if a cluster contains nodes N1, N2, and N3 and HA services are started on nodes N1 and N2 but not on node N3, you should verify that resource groups are not running on node N3. FailSafe will not perform exclusivity checks on nodes where HA services are not started.

---

When you start HA services, the following actions are performed:

- All nodes in the cluster (or the selected node only) are enabled
- FailSafe returns success to the user after modifying the cluster database
- The local cmond gets notification from the fs2d daemon
- The local cmond starts all HA processes (cmsd, gcd, srmd, fsd) and ifd
- cmond sets the failsafe2 chkconfig flag to on

### Start FailSafe HA Services with cmgr

Use the following command to start HA services:

```
start ha_services [on node Nodename] [for cluster Clustername]
```

For example:

- To start HA services across the cluster:

```
cmgr> start ha_services for cluster test-cluster
```

- To start HA services just on node N1:

```
cmgr> start ha_services on node N1 for cluster test-cluster
```

## Stop FailSafe HA Services

This section describes how to stop FailSafe HA services.

### Stop FailSafe HA Services with the GUI

You can stop HA services on all of the nodes in a cluster or on one specified node.

---

**Note:** This is a long-running task that might take a few minutes to complete.

---

Stopping a node or a cluster is a complex operation that involves several steps and can take several minutes. Aborting a stop operation can leave the nodes and the resources in an unintended state.

When stopping HA services on a node or for a cluster, the operation may fail if any resource groups are not in a stable clean state. Resource groups that are in transition will cause any stop HA services command to fail. In many cases, the command may succeed at a later time after resource groups have settled into a stable state.

After you have successfully stopped a node or a cluster, it should have no resource groups and all HA services should be gone.

Serially stopping HA services on every node in a cluster is not the same as stopping HA services for the entire cluster. In the former case, an attempt is made to keep resource groups online and highly available; in the latter case, resource groups are moved offline, as described in the following sections.

When you stop HA services, the FailSafe daemons perform the following actions:

- A shutdown request is sent to the `fsd` daemon
- `fsd` releases all resource groups and puts them in `ONLINE-READY` state

- All nodes in the cluster in the cluster database are disabled (one node at a time and the local node last)
- FailSafe waits until the node is removed from the FailSafe membership before disabling the node
- The shutdown is successful only when all nodes are not part of the FailSafe membership
- `cmnd` receives notification from the cluster database when nodes are disabled
- The local `cmnd` sends a `SIGTERM` to all HA processes and `ifd`
- All HA processes clean up and exit with “don’t restart” code
- All other `cmsd` daemons remove the disabled node from the FailSafe membership

If HA services are stopped on one node, that node’s online resource groups will be moved, according to the failover policy, to a node where HA services are active. If HA services are stopped on the cluster, all online resource groups will be taken offline, making them no longer highly available.

See the caution in "Start FailSafe HA Services with the GUI" on page 240.

### Stopping HA Services on One Node

To stop HA services on one node, enter the following:

- **Force:** click the checkbox to forcibly stop the services even if there are errors that would normally prevent them from being stopped.

The operation of stopping a node tries to move all resource groups from the node to some other node and then tries to disable the node in the cluster, subsequently killing all HA processes.

When HA services are stopped on a node, all resource groups owned by the node are moved to some other node in the cluster that is capable of maintaining these resource groups in an HA state. This operation will fail if there is no node that can take over these resource groups. This condition will always occur if the last node in a cluster is shut down when you stop HA services on that node.

In this circumstance, you can specify the **Force** option to shut down the node even if resource groups cannot be moved or released. This will normally leave resource groups allocated in a non-HA state on that same node. Using the `force` option might result in the node getting reset. In order to guarantee that the resource

groups remain allocated on the last node in a cluster, all online resource groups should be detached.

If you wish to move resource groups offline that are owned by the node being shut down, you must do so prior to stopping the node.

- **Cluster Name:** the name of the cluster is specified for you.
- **One Node Only:** select the node name.
- Click **OK** to complete the task.

### Stopping HA Services on All Nodes in a Cluster

Stopping HA services across the cluster attempts to release all resource groups and disable all nodes in the cluster, subsequently killing all HA processes.

When a cluster is deactivated and the FailSafe HA services are stopped on that cluster, resource groups are moved offline or deallocated. If you want the resource groups to remain allocated, you must detach the resource groups before attempting to deactivate the cluster.

Serially stopping HA services on every node in a cluster is not the same as stopping HA services for the entire cluster. In the former case, an attempt is made to keep resource groups online and highly available while in the latter case resource groups are moved offline.

To stop HA services on all nodes, enter the following:

- **Force:** click the checkbox to force the stop even if there are errors
- **Cluster Name:** the name of the cluster is specified for you
- **One Node Only:** leave this field blank
- Click **OK** to complete the task

### Stop FailSafe HA Services with `cmgr`

To stop FailSafe HA services, use the following command:

```
stop ha_services [on node Nodename] [for cluster Clustername] [force]
```

The `force` option will cause the stop to occur even if there are errors.

This is a long-running task might take a few minutes to complete. The `cmgr` command will provide intermediate task status for such tasks. For example:

```
cmgr> stop ha_services in cluster nfs-cluster
Making resource groups offline
Stopping HA services on node node1
Stopping HA services on node node2
```

## Set FailSafe HA Parameters

This section tells you how to set FailSafe HA parameters.

### Set FailSafe HA Parameters with the GUI

This task lets you change how FailSafe monitors the cluster and detects the need for node resets and group failovers:

1. **Cluster Name:** name of the cluster. This value is provided for you.
2. **Heartbeat Interval:** the interval, in milliseconds, between heartbeat messages. This interval must be greater than 500 milliseconds and it must not be greater than one-tenth the value of the node timeout period. This interval is set to one second, by default. It has a default value of 1000 milliseconds.

The higher the number of heartbeats (smaller heartbeat interval), the greater the potential for slowing down the network. Conversely, the fewer the number of heartbeats (larger heartbeat interval), the greater the potential for reducing availability of resources.

3. **Node Timeout:** if no heartbeat is received from a node within the node timeout period, the node is considered to be dead and is not considered part of the FailSafe membership.

Enter a value in milliseconds. The node timeout must be at least 5 seconds. In addition, the node timeout must be at least 10 times the heartbeat interval for proper FailSafe operation; otherwise, false failovers may be triggered. It has a default value of 15000 milliseconds.

Node timeout is a clusterwide parameter.

4. **Node Wait Time:** the interval, in milliseconds, during which a node waits for other nodes to join the cluster before declaring a new FailSafe membership. If the



value is not set for the cluster, FailSafe calculates this value by multiplying the **Node Timeout** value by the number of nodes.

5. **Powerfail Mode:** check the box to turn it on. The powerfail mode indicates whether a special power failure algorithm should be run when no response is received from a system controller after a reset request. Powerfail is a node-specific parameter, and should be defined for the node that performs the reset operation.
6. **Tie-Breaker Node:** select a node name. The Failsafe tiebreaker node is the node used to compute the FailSafe membership in situations where 50% of the nodes in a cluster can talk to each other. If you do not specify a tiebreaker node, the node with the lowest node ID number is used.

You should configure a tiebreaker node even if there is an odd number of nodes in the cluster because one node may be stopped, leaving an even number of nodes to determine membership.

In a cluster where the nodes are of different sizes and capabilities, the largest node in the cluster with the most important application or the maximum number of resource groups should be configured as the tiebreaker node.

### Set FailSafe HA Parameters with `cmgr`

You can modify the FailSafe parameters with the following command:

```
modify ha_parameters [on node Nodename] [in cluster Clustername]
  set node_timeout to TimeoutValue
  set heartbeat to HeartbeatInterval
  set run_pwrfail to true|false
  set node_wait to NodeWaitTime
  set tie_breaker to TieBreakerNodename
```

Usage notes:

- `node_timeout` is the node time-out period. If no heartbeat is received from a node within the node timeout period, the node is considered to be dead and is not considered part of the FailSafe membership.

Enter a value in milliseconds. The node timeout must be at least 5 seconds. In addition, the node timeout must be at least 10 times the heartbeat interval for proper FailSafe operation; otherwise, false failovers may be triggered. It has a default value of 60000 milliseconds.

`node_timeout` is a clusterwide parameter.

- `heartbeat` is the heartbeat interval, in milliseconds, between heartbeat messages. This interval must be greater than 500 milliseconds and it must not be greater than one-tenth the value of the node timeout period. This interval is set to one second, by default. It has a default value of 1000 milliseconds.

The higher the number of heartbeats (smaller heartbeat interval), the greater the potential for slowing down the network. Conversely, the fewer the number of heartbeats (larger heartbeat interval), the greater the potential for reducing availability of resources.

- `run_pwrfail` indicates whether a special power failure algorithm should be run (`true`) when no response is received from a system controller after a reset request.

Powerfail is a node-specific parameter, and should be defined for the node that performs the reset operation.

- `node_wait` is the interval, in milliseconds, during which a node waits for other nodes to join the cluster before declaring a new FailSafe membership. If the value is not set for the cluster, FailSafe calculates this value by multiplying the `node-timeout` value by the number of nodes.
- `tie_breaker` is the name of the node to act as the FailSafe tiebreaker.

Setting `tie_breaker` to "" (no space between quotation marks) unsets the `tie_breaker` value. Unsetting the `tie_breaker` is equivalent to not setting the value in the first place. In this case, FailSafe will use the node with the lowest node ID as the tiebreaker node.

## Set Log Configuration

This section describes how to set log configuration.

### Set Log Configuration with the GUI

FailSafe maintains system logs for each of the FailSafe daemons. You can customize the system logs according to the level of logging you wish to maintain. Changes apply as follows:

- To all nodes in the pool for the `cli` and `crsd` log groups
- To all nodes in the cluster for all other log groups

You can also customize the log group configuration for a specific node in the cluster or pool.

### Default Log File Names

FailSafe logs both normal operations and critical errors to the SYSLOG file, as well as to individual log files for each log group.

To set the log configuration, enter the appropriate values for the following fields:

1. **Log Group:** a log group is a set of processes that log to the same log file according to the same logging configuration. All FailSafe daemons make one log group each.

FailSafe maintains the following log groups:

cli	Commands log
crsd	Cluster reset services (crsd) log
diags	Diagnostics log
ha_agent	HA monitoring agents (ha_ifmx2) log
ha_cmsd	FailSafe membership daemon (ha_cmsd) log
ha_fsd	FailSafe daemon (ha_fsd) log
ha_gcd	Group communication daemon (ha_gcd) log
ha_ifd	Network interface monitoring daemon (ha_ifd) log
ha_script	Action and failover policy scripts log
ha_srmd	System resource manager (ha_srmd) log

2. **Log Level:** the log level, specified as character strings with the GUI and numerically (1 to 19) with `cmgr`. The log level specifies the verbosity of the logging, controlling the amount of log messages that FailSafe will write into an associated log group's file. There are 10 debug levels. Table 6-4 on page 248 shows the logging levels as you specify them with the GUI and `cmgr`.

Notifications of critical errors and normal operations are always sent to the SYSLOG file. Changes you make to the log level for a log group do not affect SYSLOG.

3. **Log File:** a file that contains FailSafe notifications for a particular log group. Log file names beginning with a slash are absolute, while names not beginning with a slash are relative to the `/var/cluster/ha/log` directory.

The FailSafe software appends the node name to the name of the log file you specify. For example, when you specify the log file name for a log group as `/var/cluster/ha/log/cli`, the file name will be `/var/cluster/ha/log/cli_Nodename`.

Table 6-5 shows the default log file names.

4. Click **OK** to complete the task.

**Table 6-4** Log Levels

GUI level	cmgr level	Meaning
Off	0	No logging
Minimal	1	Logs notification of critical errors and normal operation
Info	2	Logs minimal notification plus warning
Default	5	Logs all Info messages plus additional notifications
Debug0 through Debug9	10 through 19	Logs increasingly more debug information, including data structures. Many megabytes of disk space can be consumed on the server when debug levels are used in a log configuration.

**Table 6-5** Default Log File Names

Log File Name	Log File Owner
<code>/var/cluster/ha/log/cmsd_Nodename</code>	FailSafe membership services daemon in node <i>Nodename</i> .
<code>/var/cluster/ha/log/gcd_Nodename</code>	Group communication daemon in node <i>Nodename</i> .
<code>/var/cluster/ha/log/srmd_Nodename</code>	System resource manager daemon in node <i>Nodename</i> .
<code>/var/cluster/ha/log/failsafe_Nodename</code>	FailSafe daemon, a policy implementor for resource groups, in node <i>Nodename</i> .

Log File Name	Log File Owner
<code>/var/cluster/ha/log/AgentNodename</code>	Monitoring agent named <i>Agent</i> in node <i>Nodename</i> . For example, <code>ifd_Nodename</code> is the log file for the interface daemon monitoring agent that monitors interfaces and IP addresses and performs local failover of IP addresses.
<code>/var/cluster/ha/log/crsd_Nodename</code>	Reset daemon in node <i>nodename</i> .
<code>/var/cluster/ha/log/script_Nodename</code>	Scripts in node <i>nodename</i> .
<code>/var/cluster/ha/log/cli_Nodename</code>	Internal administrative commands in node <i>nodename</i> invoked by the GUI and <code>cmgr</code> .

### Display Log Group Definitions with the GUI

To display log group definitions with the GUI, select the **Log Group** menu. The current log level and log file for that log group will be displayed in the task window, where you can change those settings if you desire.

### Define Log Groups with `cmgr`

Use the following command to define a log group:

```
define log_group Groupname [on node Nodename] [in cluster Clustername]
    set log_level to Level
    add log_file Logfilename
    remove log_file Logfilename
```

Usage notes:

- Specify the node name if you wish to customize the log group configuration for a specific node only. For details about legal values, see "Set Log Configuration with the GUI" on page 246.
- `log_level` can have one of the following values:
  - 0 gives no logging
  - 1 logs notifications of critical errors and normal operation (these messages are also logged to the `SYSLOG` file)
  - 2 logs Minimal notifications plus warnings

- 5 through 7 log increasingly more detailed notifications
- 10 through 19 log increasingly more debug information, including data structures
- `log_file` is the file that contains FailSafe notifications for a particular log group. Log file names beginning with a slash are absolute, while names not beginning with a slash are relative to the `/var/cluster/ha/log` directory.

The FailSafe software appends the node name to the name of the log file you specify. For example, when you specify the log file name for a log group as `/var/cluster/ha/log/cli`, the file name will be `/var/cluster/ha/log/cli_Nodename`.

For a list of default log names, see Table 6-5 on page 248.

### Configure Log Groups with `cmgr`

You can configure a log group with the following command:

```
define log_group LogGroup on node Nodename [in cluster Clustername]
```

The `LogGroup` variable can be one of the following:

```
cli
crsd
diags
ha_agent
ha_cmsd
ha_fsd
ha_gcd
ha_ifd
ha_script
ha_srmd
```



**Caution:** Do not change the names of the log files. If you change the names, errors can occur.

---

For example, to define log group `cli` on node `fs6` with a log level of 5:

```
cmgr> define log_group cli on node fs6 in cluster fs6-8
```

(Enter "cancel" at any time to abort)

Log Level ? (11) 5

CREATE LOG FILE OPTIONS

- 1) Add Log File.
- 2) Remove Log File.
- 3) Show Current Log Files.
- 4) Cancel. (Aborts command)
- 5) Done. (Exits and runs command)

Enter option:5

Successfully defined log group cli

### Modify Log Groups with `cmgr`

Use the following command to modify a log group:

```
modify log_group LogGroupName on node Nodename [in cluster Clustername]
```

You modify a log group using the same commands you use to define a log group. See "Define Log Groups with `cmgr`" on page 249.

For example, to change the log level of `cli` to be 10, enter the following:

```
cmgr> modify log_group cli on node fs6 in cluster fs6-8
```

(Enter "cancel" at any time to abort)

Log Level ? (2) 10

MODIFY LOG FILE OPTIONS

- 1) Add Log File.
- 2) Remove Log File.
- 3) Show Current Log Files.
- 4) Cancel. (Aborts command)
- 5) Done. (Exits and runs command)

Enter option:5

Successfully modified log group cli

For example, to set the log level for the `ha_script` log group to 11, enter the following:

```
cmgr> modify log_group ha_script

log_group ha_script ? set log_level to 11
log_group ha_script ? done
Successfully modified log group ha_script
```

### Display Log Group Definitions

This section describes how to display log group definitions.

#### Display Log Group Definitions with `cmgr`

Use the following command to display log group levels:

```
show log_groups
```

This command shows the currently defined log group names, their logging levels, and the log files. For example:

```
cmgr> show log_groups

ha_cmsd 13 /var/cluster/ha/log/cmsd
crsd 5 /var/cluster/ha/log/crsd
ha_gcd 5 /var/cluster/ha/log/gcd
ha_ifd 5 /var/cluster/ha/log/ifd
ha_srmd 14 /var/cluster/ha/log/srmd
ha_fsd 11 /var/cluster/ha/log/failsafe
cli 2 /var/cluster/ha/log/cli
ha_script 13 /var/cluster/ha/log/script
ha_agent 5 CommandName
diags 2 /var/cluster/ha/log/diags
clconfd 5 /var/cluster/ha/log/clconfd
```

In this example, `ha_cmsd` is the name of logging group used by the `ha_cmsd` daemon to log messages. The log verbosity level for `ha_cmsd` is 13; the verbosity level range from 0 (no message) to 19 (most verbose). The log file used is `/var/cluster/ha/log/cmsd`. A node name suffix is added to all log file names.



Use the following command to see messages logged by a specific daemon on a specific node:

```
show log_group LogGroupName [on node Nodename]
```

To exit from the message display, enter Cntrl-C.



## Configuration Examples

This chapter contains the following sections:

- "Example: Script to Define an SGI File Server 850 Cluster"
- "Example: Script to Define an SGI SAN Server 1000 Cluster" on page 263
- "Example: Script to Define a Three-Node Cluster" on page 269
- "Example: Modify a Cluster to Include a CXFS Filesystem" on page 276
- "Example: Export CXFS Filesystems" on page 277
- "Example: Create a Resource Group" on page 278
- "Example: Local Failover of HA IP Address" on page 279

### **Example: Script to Define an SGI File Server 850 Cluster**

The script in this section configures an SGI File Server 850 cluster, which has two Origin 300 nodes in a FailSafe configuration attached to an SGI TP9100 RAID. Figure 7-1 shows an example of this configuration.

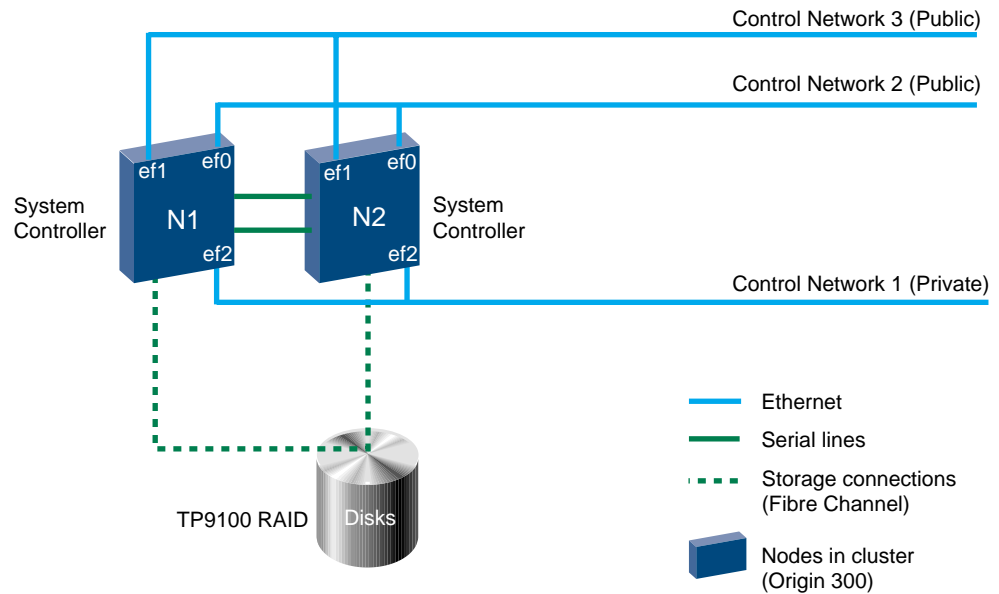

**Figure 7-1** SGI File Server 850 Configuration

All highly available (HA) services run on one node and the other node is the backup node. After failover, the services run on the backup node. In this case, the backup node is a hot standby for failover purposes only. The backup node can run other applications that are not HA services.

This configuration uses the following component names:

- Nodes names:
  - N1
  - N2
- Cluster name: `fileserver850cluster`
- Resource groups:
  - RG1
  - RG2

**Table 7-1** SGI File Server 850 Resources and Failover Policies for RG1 and RG2

Resources and Failover Policy	RG1	RG2
Resources		
IP_address	192.26.50.1	192.26.50.2
filesystem	/ha1	/ha2
volume	ha1_vol	ha2_vol
NFS	/ha1/export	/ha2/export
Failover policy		
Name	fp1	fp2
Script	ordered	ordered
Attributes	Auto_Failback, Auto_Recovery	Auto_Failback, Auto_Recovery
Failover domain	N1, N2	N1, N2

Figure 7-2 describes the resource dependencies.

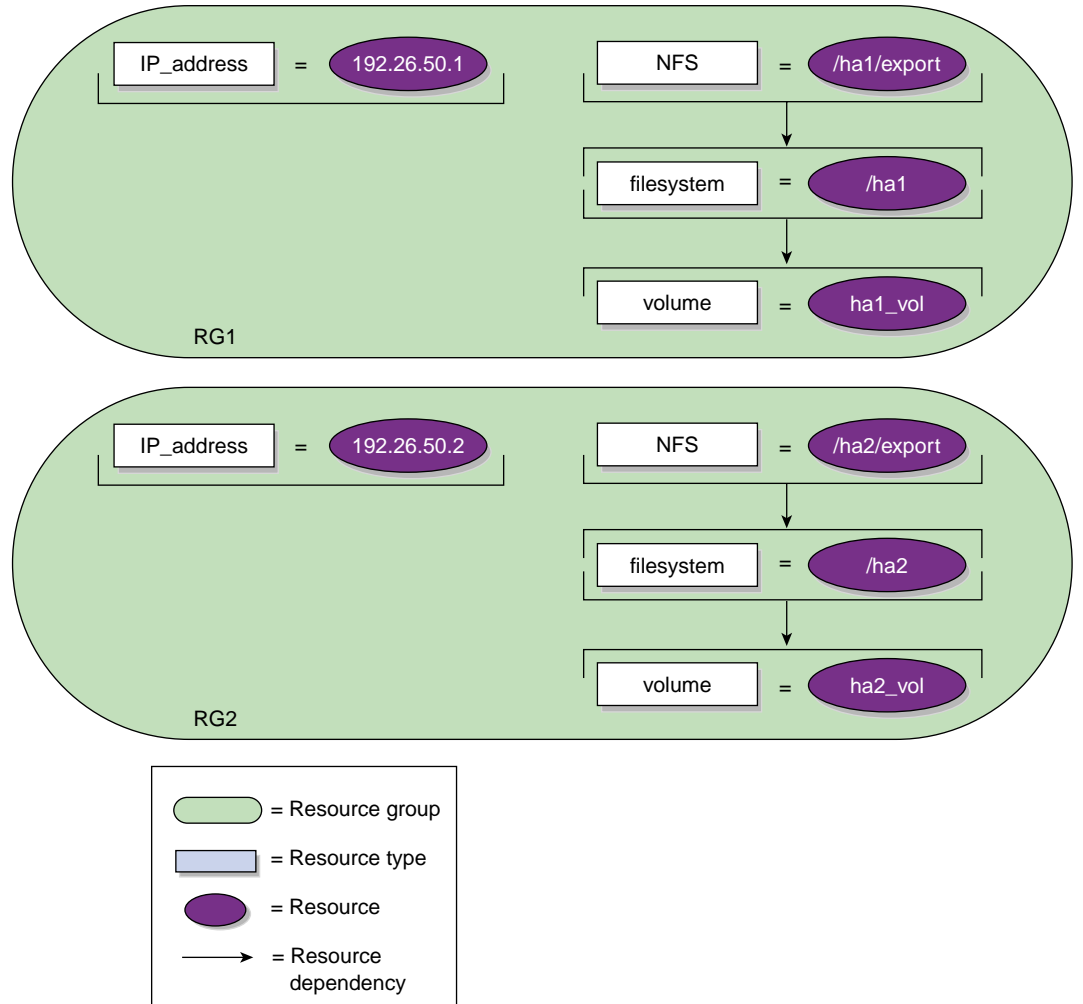

Figure 7-2 Resource Dependencies for SGI File Server 850

The cmgr script used to define this configuration is as follows:

```
#!/usr/cluster/bin/cmgr -f
define node N1
    set hostname to N1
    set is_failsafe to true
    set sysctrl_type to l1
    set sysctrl_status to enabled
    set sysctrl_password to none
    set sysctrl_owner to N2
    set sysctrl_device to /dev/ttyd2
    set sysctrl_owner_type to tty
    add nic ef0-N1
        set heartbeat to true
        set ctrl_msgs to true
        set priority to 1
    done
    add nic ef1-N1
        set heartbeat to true
        set ctrl_msgs to true
        set priority to 2
    done
done

define node N2
    set hostname to N2
    set is_failsafe to true
    set sysctrl_type to l1
    set sysctrl_status to enabled
    set sysctrl_password to none
    set sysctrl_owner to N1
    set sysctrl_device to /dev/ttyd2
    set sysctrl_owner_type to tty
    add nic ef0-N2
        set heartbeat to true
        set ctrl_msgs to true
        set priority to 1
    done
    add nic ef1-N2
        set heartbeat to true
```

```
                set ctrl_msgs to true
                set priority to 2
            done
done

define cluster fileserver850cluster
    set is_failsafe to true
    set notify_cmd to /usr/bin/mail
    set notify_addr to failsafe_sysadm@company.com
    add node N1
    add node N2
done

define failover_policy fp1
    set attribute to Auto_Failback
    set attribute to Auto_Recovery
    set script to ordered
    set domain to N1 N2
done

define failover_policy fp2
    set attribute to Auto_Failback
    set attribute to Auto_Recovery
    set script to ordered
    set domain to N2 N1
done

set cluster fileserver850cluster

define resource 192.26.50.1 of resource_type IP_address
    set NetworkMask to 0xffffffff
    set interfaces to ef0,ef1
    set BroadcastAddress to 192.26.50.255
done

define resource hal_vol of resource_type volume
    set devname-owner to root
    set devname-group to sys
    set devname-mode to 600
```



```
done

define resource /hal of resource_type filesystem
    set volume-name to hal_vol
    set mount-options to rw,noauto
    set monitor-level to 2
done

modify resource /hal of resource_type filesystem
    add dependency hal_vol of type volume
done

define resource /hal/export of resource_type NFS
    set export-info to rw,wsync
    set filesystem to /hal
done

modify resource /hal/export of resource_type NFS
    add dependency /hal of type filesystem
done

define resource_group RG1
    set failover_policy to fp1
    add resource 192.26.50.1 of resource_type IP_address
    add resource hal_vol of resource_type volume
    add resource /hal of resource_type filesystem
    add resource /hal/export of resource_type NFS
done

define resource 192.26.50.2 of resource_type IP_address
    set NetworkMask to 0xffffffff
    set interfaces to ef0
    set BroadcastAddress to 192.26.50.255
done

define resource ha2_vol of resource_type volume
    set devname-owner to root
    set devname-group to sys
    set devname-mode to 600
done
```

```
define resource /ha2 of resource_type filesystem
    set volume-name to ha2_vol
    set mount-options to rw,noauto
    set monitor-level to 2
done

modify resource /ha2 of resource_type filesystem
    add dependency ha2_vol of type volume
done

define resource /ha2/export of resource_type NFS
    set export-info to rw,wsync
    set filesystem to /ha2
done

modify resource /ha2/export of resource_type NFS
    add dependency /ha2 of type filesystem
done

define resource_group RG2
    set failover_policy to fp2
    add resource 192.26.50.2 of resource_type IP_address
    add resource ha2_vol of resource_type volume
    add resource /ha2 of resource_type filesystem
    add resource /ha2/export of resource_type NFS
done

quit
```

## Example: Script to Define an SGI SAN Server 1000 Cluster

The script in this section configures an SGI SAN Server 1000 cluster, which has two Origin 300 nodes in a FailSafe configuration, shown in Figure 7-3. Both Origin 300 nodes are attached to a SGI TP9400 RAID using a Brocade Fibre Channel switch. Both nodes act as CXFS metadata servers. There can be one or more CXFS metadata clients.

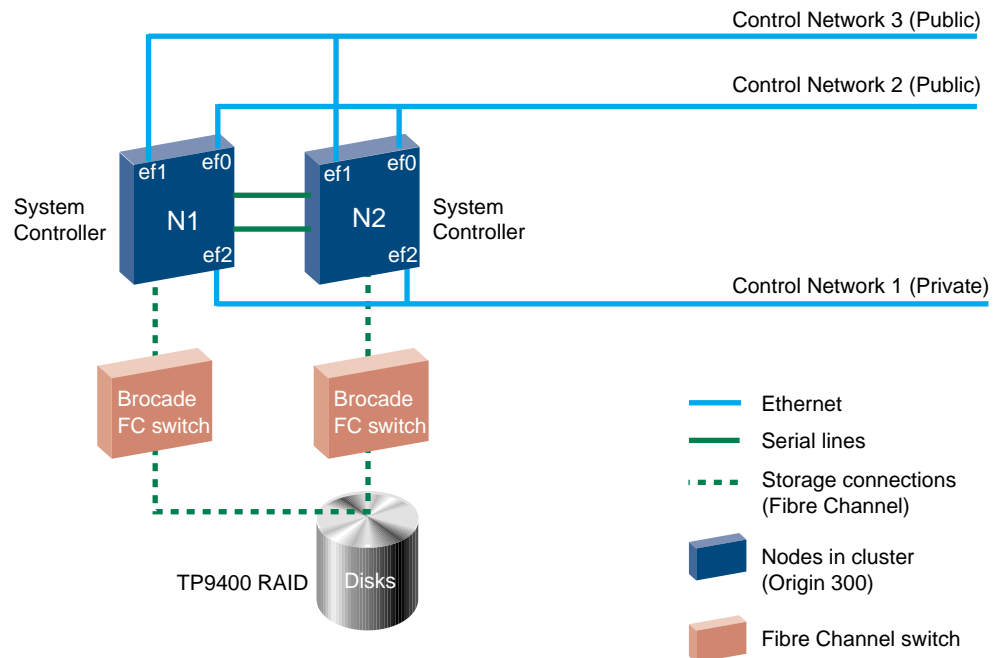

**Figure 7-3** SGI SAN Server Configuration

All HA services run on one node and the other node is the backup node. After failover, the services run on the backup node. In this case, the backup node is a hot standby for failover purposes only. The backup node can run other applications that are not HA services.

The resource groups contain a CXFS filesystem, NFS export point, and an IP address. The `/ha_cxfs1` and `/ha_cxfs2` CXFS filesystems use metadata servers named N1 and N2.

This configuration uses the following component names:

- Node names:
  - N1
  - N2
- Cluster name: sanserver1000cluster
- Resource groups:
  - RG1
  - RG2

**Table 7-2** SGI SAN Server Resources and Failover Policies for RG1 and RG2

Resources and Failover Policy	RG1	RG2
Resources		
IP_address	192.26.50.1	192.26.50.2
CXFS	/ha_cxfs1	/ha_cxfs2
NFS	/ha_cxfs1/export	/ha_cxfs2/export
Failover policy		
Name	fp1	fp2
Script	ordered	ordered
Attributes	Auto_Failback, Auto_Recovery	Auto_Failback, Auto_Recovery
Failover domain	N1, N2	N1, N2

Figure 7-4 describes the resource dependencies.

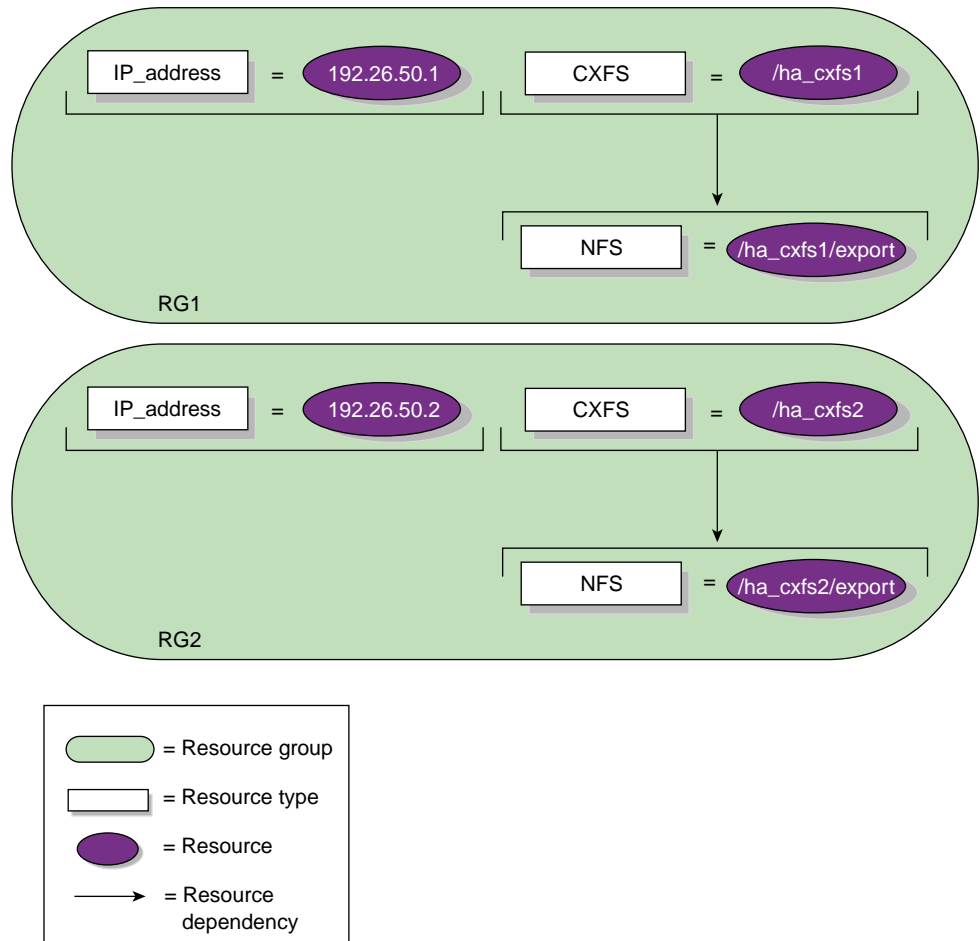

**Figure 7-4** Resource Dependencies for SGI SAN Server

The cmgr script used to define this configuration is as follows:

```
#!/usr/cluster/bin/cmgr -f

define node N1
    set hostname to N1
    set is_failsafe to true
    set is_cxfs to true
```

```
        set sysctrl_type to l1
        set sysctrl_status to enabled
        set sysctrl_password to none
        set sysctrl_owner to N2
        set sysctrl_device to /dev/ttyd2
        set sysctrl_owner_type to tty
        set operating_system to IRIX
        set weight to 1
        set hierarchy to Reset

    add nic ef0-N1
        set heartbeat to true
        set ctrl_msgs to true
        set priority to 1

done
add nic ef1-N1
    set heartbeat to true
    set ctrl_msgs to true
    set priority to 2

done
done

define node N2
    set hostname to N2
    set is_failsafe to true
    set is_cxfs to true
    set sysctrl_type to l1
    set sysctrl_status to enabled
    set sysctrl_password to none
    set sysctrl_owner to N1
    set sysctrl_device to /dev/ttyd2
    set sysctrl_owner_type to tty
    set operating_system to IRIX
    set weight to 1
    set hierarchy to Reset

    add nic ef0-N2
        set heartbeat to true
        set ctrl_msgs to true
        set priority to 1
```

```
done
add nic efl-N2
    set heartbeat to true
    set ctrl_msgs to true
    set priority to 2
done
done

define cluster sanserver1000cluster
    set is_failsafe to true
    set is_cxfs to true
    set clusterid to 1
    set notify_cmd to /usr/bin/mail
    set notify_addr to sanserver1000_sysadm@company.com
    add node N1
    add node N2
done

define failover_policy fp1
    set attribute to Auto_Failback
    set attribute to Auto_Recovery
    set script to ordered
    set domain to N1 N2
done

define failover_policy fp2
    set attribute to Auto_Failback
    set attribute to Auto_Recovery
    set script to ordered
    set domain to N2 N1
done

set cluster sanserver1000cluster

define resource 192.26.50.1 of resource_type IP_address
    set NetworkMask to 0xffffffff
    set interfaces to ef0,ef1
    set BroadcastAddress to 192.26.50.255
done
```

```
define resource /ha_cxfs1 of resource_type CXFS
    set relocate-mds to true
done

define resource /ha_cxfs1/export of resource_type NFS
    set export-info to rw,wsync
    set filesystem to /ha_cxfs1
done

modify resource /ha_cxfs1/export of resource_type NFS
    add dependency /ha_cxfs1 of type CXFS
done

define resource_group RG1
    set failover_policy to fp1
    add resource 192.26.50.1 of resource_type IP_address
    add resource /ha_cxfs1 of resource_type CXFS
    add resource /ha_cxfs1/export of resource_type NFS
done

define resource 192.26.50.2 of resource_type IP_address
    set NetworkMask to 0xffffffff
    set interfaces to ef0
    set BroadcastAddress to 192.26.50.255
done

define resource /ha_cxfs2 of resource_type CXFS
    set relocate-mds to true
done

define resource /ha_cxfs2/export of resource_type NFS
    set export-info to rw,wsync
    set filesystem to /ha_cxfs2
done

modify resource /ha_cxfs2/export of resource_type NFS
    add dependency /ha_cxfs2 of type CXFS
done
```



```
define resource_group RG2
    set failover_policy to fp2
    add resource 192.26.50.2 of resource_type IP_address
    add resource /ha_cxfs2 of resource_type CXFS
    add resource /ha_cxfs2/export of resource_type NFS

done

quit
```

### **Example: Script to Define a Three-Node Cluster**

This section provides an example `cmgr` script that defines a FailSafe three-node cluster as shown in Figure 7-5. This configuration consists of a pool containing nodes N1, N2, N3, and N4. Nodes N1, N2, and N3 make up the FailSafe cluster. The nodes in this cluster share disks, and are connected to an Etherlite network-based serial port multiplexer, which is also connected to the private control network.

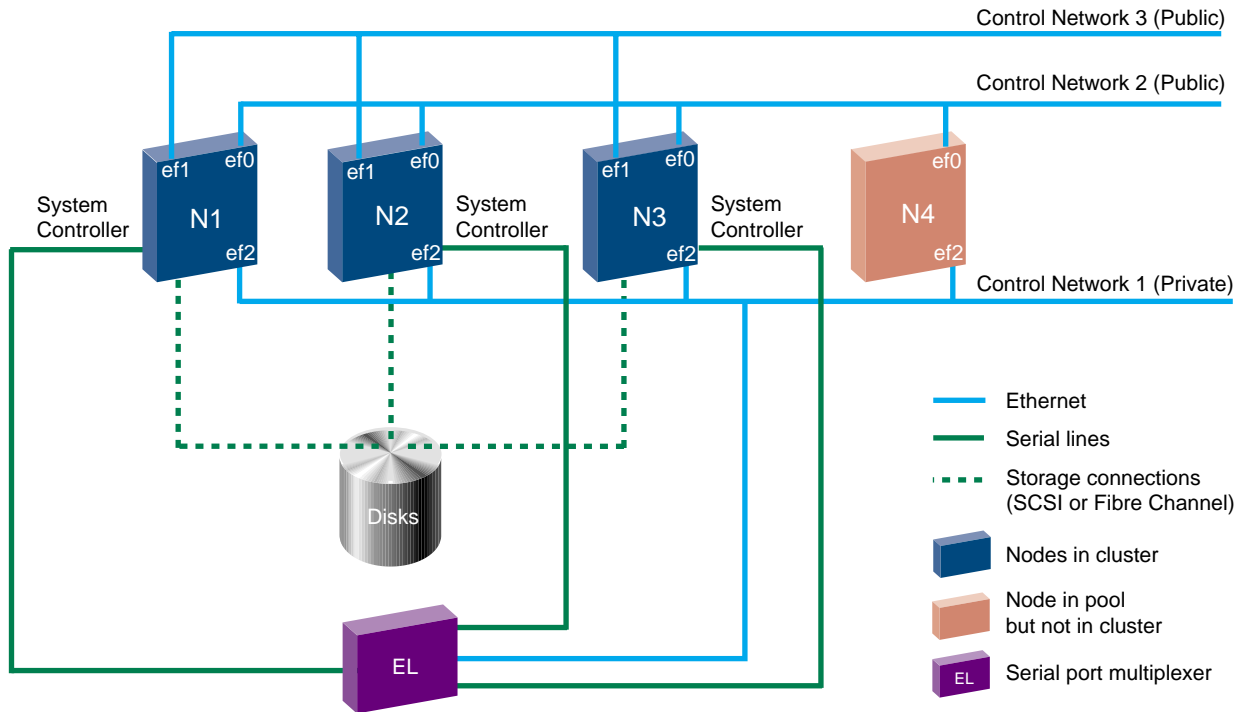

**Figure 7-5** FailSafe Configuration Example

For general information on `cmgr` scripts see "Using Script Files" on page 133. For information on the template files that you can use to create your own configuration script, see "Template Scripts" on page 138.

This cluster has two resource groups, RG1 and RG2, as shown in Table 7-3.

**Table 7-3** Resources and Failover Policies for RG1 and RG2

Resources and Failover Policy	RG1	RG2
Resources		
IP_address	192.26.50.1	192.26.50.2
filesystem	/ha1	/ha2

Resources and Failover Policy	RG1	RG2
volume	ha1_vol	ha2_vol
NFS	/ha1/export	/ha2/export
Failover policy		
Name	fp1	fp2
Script	ordered	round-robin
Attributes	Auto_Failback, Auto_Recovery	Controlled_Failback, InPlace_Recovery
Failover domain	N1, N2, N3	N2, N3

The cmgr script used to define this configuration is as follows:

```
#!/usr/cluster/bin/cmgr -f
define node N1
    set hostname to N1
    set is_failsafe to true
    set sysctrl_type to msc
    set sysctrl_status to enabled
    set sysctrl_password to none
    set sysctrl_owner to N4
    set sysctrl_device to /dev/ttydn001
    set sysctrl_owner_type to tty
    add nic ef2-N1
        set heartbeat to true
        set ctrl_msgs to true
        set priority to 1
    done
    add nic ef0-N1
        set heartbeat to true
        set ctrl_msgs to true
        set priority to 2
    done
    add nic ef1-N1
        set heartbeat to true
        set ctrl_msgs to true
        set priority to 3
    done
done
```

```
define node N2
    set hostname to N2
    set is_failsafe to true
    set sysctrl_type to msc
    set sysctrl_status to enabled
    set sysctrl_password to none
    set sysctrl_owner to N4
    set sysctrl_device to /dev/ttydn002
    set sysctrl_owner_type to tty
    add nic ef2-N2
        set heartbeat to true
        set ctrl_msgs to true
        set priority to 1
    done
    add nic ef0-N2
        set heartbeat to true
        set ctrl_msgs to true
        set priority to 2
    done
    add nic ef1-N2
        set heartbeat to true
        set ctrl_msgs to true
        set priority to 3
    done
done

define node N3
    set hostname to N3
    set is_failsafe to true
    set sysctrl_type to msc
    set sysctrl_status to enabled
    set sysctrl_password to none
    set sysctrl_owner to N4
    set sysctrl_device to /dev/ttydn003
    set sysctrl_owner_type to tty
    add nic ef2-N3
        set heartbeat to true
        set ctrl_msgs to true
        set priority to 1
```

```
done
add nic ef0-N3
    set heartbeat to true
    set ctrl_msgs to true
    set priority to 2
done
add nic ef1-N3
    set heartbeat to true
    set ctrl_msgs to true
    set priority to 3
done
done

define node N4
    set hostname to N4
    set is_failsafe to true
    add nic ef2-N4
        set heartbeat to true
        set ctrl_msgs to true
        set priority to 1
    done
    add nic ef0-N4
        set heartbeat to true
        set ctrl_msgs to true
        set priority to 2
    done
done

define cluster TEST
    set is_failsafe to true
    set notify_cmd to /usr/bin/mail
    set notify_addr to failsafe_sysadm@company.com
    add node N1
    add node N2
    add node N3
done

define failover_policy fp1
    set attribute to Auto_Failback
    set attribute to Auto_Recovery
    set script to ordered
```

```
        set domain to N1 N2 N3
done

define failover_policy fp2
    set attribute to Controlled_Failback
    set attribute to InPlace_Recovery
    set script to round-robin
    set domain to N2 N3
done

define resource 192.26.50.1 of resource_type IP_address in cluster TEST
    set NetworkMask to 0xffffffff
    set interfaces to ef0,ef1
    set BroadcastAddress to 192.26.50.255
done

define resource hal_vol of resource_type volume in cluster TEST
    set devname-owner to root
    set devname-group to sys
    set devname-mode to 666
done

define resource /hal of resource_type filesystem in cluster TEST
    set volume-name to hal_vol
    set mount-options to rw,noauto
    set monitor-level to 2
done

modify resource /hal of resource_type filesystem in cluster TEST
    add dependency hal_vol of type volume
done

define resource /hal/export of resource_type NFS in cluster TEST
    set export-info to rw,wsync
    set filesystem to /hal
done

modify resource /hal/export of resource_type NFS in cluster TEST
    add dependency /hal of type filesystem
done
```

```
define resource_group RG1 in cluster TEST
    set failover_policy to fp1
    add resource 192.26.50.1 of resource_type IP_address
    add resource ha1_vol of resource_type volume
    add resource /ha1 of resource_type filesystem
    add resource /ha1/export of resource_type NFS
done

define resource 192.26.50.2 of resource_type IP_address in cluster TEST
    set NetworkMask to 0xffffffff00
    set interfaces to ef0
    set BroadcastAddress to 192.26.50.255
done

define resource ha2_vol of resource_type volume in cluster TEST
    set devname-owner to root
    set devname-group to sys
    set devname-mode to 666
done

define resource /ha2 of resource_type filesystem in cluster TEST
    set volume-name to ha2_vol
    set mount-options to rw,noauto
    set monitor-level to 2
done

modify resource /ha2 of resource_type filesystem in cluster TEST
    add dependency ha2_vol of type volume
done

define resource /ha2/export of resource_type NFS in cluster TEST
    set export-info to rw,wsync
    set filesystem to /ha2
done

modify resource /ha2/export of resource_type NFS in cluster TEST
    add dependency /ha2 of type filesystem
done
```

```
define resource_group RG2 in cluster TEST
    set failover_policy to fp2
    add resource 192.26.50.2 of resource_type IP_address
    add resource ha2_vol of resource_type volume
    add resource /ha2 of resource_type filesystem
    add resource /ha2/export of resource_type NFS
done

quit
```

## Example: Modify a Cluster to Include a CXFS Filesystem

The following procedural example modifies the sample FailSafe configuration illustrated in Figure 7-5 on page 270, so that it includes HA NFS services on a CXFS filesystem. However, the CXFS resource type does not mount a CXFS filesystem. You should mount CXFS filesystem using the CXFS GUI as described in the *CXFS Administration Guide for SGI InfiniteStorage*. The CXFS resource type monitors the CXFS filesystem for mount failures.

---

**Note:** Local XVM volumes use the XVM resource type.

---

To modify the FailSafe configuration to include a CXFS filesystem, perform the following steps:

1. Convert the cluster TEST for CXFS use. For information on converting FailSafe clusters to CXFS, see the *CXFS Administration Guide for SGI InfiniteStorage*.
2. Convert the nodes N1 and N2 for CXFS use. For information on converting FailSafe nodes to CXFS, see the *CXFS Administration Guide for SGI InfiniteStorage*. Start CXFS services on the nodes.
3. Create a new resource type NFS1. This is the same as resource type NFS but without a filesystem dependency. To create this resource type you can perform the following steps:
  - a. Using `cmgr`, execute the following:

```
cmgr> show resource_type NFS in cluster TEST
```

The parameters of resource type NFS will be displayed.



- b. Define resource type `NFS1` using the same configuration information that was displayed for resource type `NFS`, but do not copy the filesystem dependency.
4. Define a new failover policy, `FP3`, with the following attributes:
  - Failover domain: `N1, N2`
  - Script: `ordered`
  - Attribute: `InPlace_Recovery`
5. Create a resource named `/cxfs` of resource type `CXFS`. `/cxfs` is the mount point of the CXFS filesystem. You can decide to relocate the metadata server of the CXFS filesystem `/cxfs` when the resource group moves to another node.
6. Create a resource group named `rg3` with failover policy `fp3`, resource `ip3` of resource type `IP_address`, and resource `/cxfs` of resource type `CXFS`.
7. Mount `/cxfs` on nodes `N1` and `N2`. For information on defining and mounting a CXFS filesystem with an XVM volume, see the *CXFS Administration Guide for SGI InfiniteStorage*.
8. Bring resource group `RG3` online in cluster `TEST`.

## Example: Export CXFS Filesystems

Perform the following steps to export CXFS filesystems in a FailSafe configuration:

1. Ensure that the latest patches (if any) of the FailSafe NFS 2.2 release are installed on all FailSafe nodes in the cluster.
2. Perform all of the steps mentioned in "Example: Modify a Cluster to Include a CXFS Filesystem" on page 276.
3. If you are planning to export the `/cxfs/share` directory, create an NFS resource named `/cxfs/share`.
4. Add the NFS resource to the resource group `rg3` in addition to the HA IP address resource and the CXFS resource, using the following commands:

```
define resource_group rg3 in cluster TEST
set failover_policy to fp3
add resource 99.92.99.99 of resource_type IP_address
add resource /cxfs of resource_type CXFS
```

```
add resource /cxfs/share of resource_type NFS
done
```

---

**Note:** You cannot use this procedure to export the same CXFS filesystem or subdirectory from multiple nodes in the cluster.

---

## Example: Create a Resource Group

Use the following procedure to create a resource group using `cmgr`:

1. Determine the list of resources that belong to the resource group you are defining. The list of resources that belong to a resource group are the resources that move from one node to another as one unit.

A resource group that provides NFS services would contain a resource of each of the following types:

- IP\_address
- volume
- filesystem
- NFS

All resource and resource-type dependencies must be satisfied. For example, the NFS resource type depends on the `filesystem` resource type, so a resource group containing a resource of NFS resource type must also contain a resource of `filesystem` resource type.

2. Determine the failover policy to be used by the resource group.
3. Use the template `cluster_mgr` script available in the `/var/cluster/cmgr-templates/cmgr-create-resource_group` file.

This example shows a script that creates a resource group with the following characteristics:

- The resource group is named `nfs-group`.
- The resource group is in cluster `HA-cluster`.
- The resource group uses the failover policy.

- The resource group contains IP\_Address, volume, filesystem, and NFS resources.

The following example script can be used to create this resource group:

```
define resource_group nfs-group in cluster HA-cluster
    set failover_policy to n1_n2_ordered
    add resource 192.0.2.34 of resource_type IP_address
    add resource havoll of resource_type volume
    add resource /hafs1 of resource_type filesystem
    add resource /hafs1 of resource_type NFS
done
```

4. Run this script using the `-f` option of the `cmgr` command.

## Example: Local Failover of HA IP Address

FailSafe allows multiple network interfaces in a machine to be assigned to an HA IP address. FailSafe will attempt to failover the IP address to a backup network interface before attempting to failover the resource group containing the IP address to another node in the cluster. This local failover of IP address requires modification to the `IP_address` resource type `start` and `restart` scripts. Modifications involve changes to network routing table. This section provides a local IP failover procedure with modified `start` and `restart` scripts, allowing a correct local IP failover.

IRIX allows only one interface to be configured up in a subnet. One or more backup interfaces should be configured in dummy subnets that are not used at the site during machine boot up process. All the interfaces should be physically connected to the same subnet.

---

**Note:** This configuration will send several routed messages into the `SYSLOG`. An option is to turn off warnings about messages received on unexpected interfaces.

---

This local failover procedure will swap the base address of the failed interface with the base address of the backup interface and configure the HA IP address on the new network interface. The `IP_address` resource type scripts will update the network routing table.

---

**Note:** The following modifications have been tested for configurations with one IP alias per HBA only. For configurations that use two or more IP aliases in the same network, the `restart` script should have a locking mechanism so that for one interface only one instance of restart can run at a time.

---

The examples in this section show how to configure two interfaces for local IP failover. They use the configuration illustrated in Figure 7-5 on page 270.

1. Define an HA `IP_address` resource with two interfaces:

```
define resource 192.26.50.1 of resource_type IP_address in cluster TEST
    set NetworkMask to 0xffffffff
    set BroadcastAddress to 192.26.50.255
    set interfaces to ef0,ef1
done
```

HA IP address 192.26.50.1 will be locally failed over from interface `ef0` to interface `ef1` when there is an `ef0` interface failure. The base address of `ef0` will be assigned to `ef1` and the failed interface `ef0` will get the dummy base address of `ef1`.

In nodes `N1`, `N2`, and `N3`, both `ef0` and `ef1` should configure up automatically, when the node boots up. Both `ef0` and `ef1` are physically connected to the same subnet 192.26.50. Only one network interface connected to the same network should be configured in the 192.26.50 subnet.

2. Modify the `/etc/conf/netif.options` file to configure the `ef0` and `ef1` interfaces:

```
if1name=ef0
if1addr=192.26.50.10

if2name=ef1
if2addr=10.1.1.1
```

The network used for `ef1` is a dummy network and should not physically exist and should not be a reachable network from the cluster nodes.

In order to use this workaround, the `start` and `restart` scripts of the resource type `IP_address` must be modified. In the following example scripts, the modified sections are highlighted by comments and bold text.

## Example start Script Modified for Local IP Failover

The following shows a portion of the start script modified to support local HA IP failover.

```
#
# Configure IP address. The list of ipaddresses are in $HA_INFILE.
#
start_ipaddresses()
{
    # Obtain an interface, netmask and broadcast address for
    # all the ip addresses from the interface daemon.
    HA_CMD="{LOCAL_IFDADMIN} -g $HA_INFILE $LOCAL_TMPFILE"
    ha_execute_cmd "obtaining an interface for the ip addresses"

    if [ $? -ne 0 ]; then
        # Initialize $HA_RES_NAMES
        ha_read_infile;
        ha_write_status_for_all_resources $HA_CMD_FAILED;
        ${HA_LOG} "Check if ha_ifd process is running"
        ${HA_LOG} "ha_ifadmin command failed to obtain interface for ip address"
        exit_script $HA_CMD_FAILED;
    fi

    IPADDR_FAILED=false;

    # Read the information returned by ha_ifdadmin command and configure
    # the ip addresses
    while read IPADDR_ENTRY
    do
        set $IPADDR_ENTRY
        # $1 has IP address, $2 has interface name or "error"
        # $3 has netmask and $4 has broadcast address

        if [ $2 = "error" ]; then
            ${HA_LOG} "ip address $1 cannot be configured";
            ${HA_LOG} "Check ha_ifd logs on this node for more information"
            ha_write_status_for_resource $1 $HA_CMD_FAILED;
            continue;
        fi

        IP_ADDR=$1
    done
}
```

## 7: Configuration Examples

---

```
IF_NAME=$2
IP_MASK=$3
IP_BRDA=$4

#### Local IP Failover modification Start

# Checking if the IF_NAME is configured with the correct base address
# If not it will be set to the one with the right base address

IF_NAME=`/usr/etc/route get ${IP_ADDR}|/sbin/grep interface|/usr/bin/awk '{print $2}'`

#### Local IP Failover modification End

# Configure the interface up before adding the IP_ADDR. The interface
# might be configured down
echo $IF_NAME | /usr/bin/egrep "rns[0-9]+|xpi[0-9]+" > /dev/null
if [ $? -eq 0 ]; then
    HA_CMD="/usr/etc/smtconfig $IF_NAME up"
else
    HA_CMD="/usr/etc/ifconfig $IF_NAME up"
fi
ha_execute_cmd "configuring interface ${IF_NAME} up"

if [ $? -ne 0 ]; then
    IPADDR_FAILED=true;
    ${HA_LOG} "ip address $1 cannot be configured";
    ha_write_status_for_resource $IP_ADDR $HA_CMD_FAILED;
    continue;
fi

HA_CMD="/usr/etc/ifconfig $IF_NAME alias $IP_ADDR netmask $IP_MASK"
ha_execute_cmd "configuring ip address ${IP_ADDR}"

if [ $? -ne 0 ]; then
    IPADDR_FAILED=true;
    ${HA_LOG} "${HA_CMD} failed"
    ha_write_status_for_resource $IP_ADDR $HA_CMD_FAILED;
    continue;
fi

#
```

```

# Do not send arp packet for GSN interfaces
#
echo ${IF_NAME} | /usr/bin/egrep "gsn[0-9]+|hip[0-9]+|lb[0-9]+" > /dev/null
if [ $? -ne 0 ]; then
    echo ${IF_NAME} | /usr/bin/egrep "el[0-9]+" > /dev/null
    if [ $? -eq 0 ]; then
        sleep 5;
    fi
    HA_CMD="${HA_CMDSPATH}/ha_macconfig2 arp ${IF_NAME} ${IP_ADDR}"
    ha_execute_cmd "sending arp packet for ${IP_ADDR}"

    if [ $? -ne 0 ]; then
        IPADDR_FAILED=true;
        ${HA_LOG} "${HA_CMD} failed"
        ha_write_status_for_resource $IP_ADDR $HA_CMD_FAILED;
        continue;
    fi
fi

ha_write_status_for_resource $IP_ADDR $HA_SUCCESS;

done < $LOCAL_TMPFILE
#
# If there is no failure, remove local tmp file.
#
if [ X${IPADDR_FAILED} = "Xfalse" ]; then
    /sbin/rm -f ${LOCAL_TMPFILE};
fi

#
# Restart autofsd so that it can read new IP aliases configuration
#
/sbin/killall -HUP autofsd;
/sbin/killall -USR1 ha_ifd;
}

```

### Example restart Script Modified for Local IP Failover

The following shows a portion of the restart script modified to support local HA IP failover.

## 7: Configuration Examples

---

```
#
# Local restart IP addresses. The list of ipaddresses are in $HA_INFILE.
#
restart_ipaddresses()
{
    IPADDR_FAILED=false;

    # Obtain the current interface, netmask and broadcast address for
    # all the ip addresses from the interface daemon.
    HA_CMD="${LOCAL_IFDADMIN} -i ${HA_INFILE} ${LOCAL_TMPFILE1_CURRENT}"
    ha_execute_cmd "obtaining current interface for the ip addresses"

    if [ $? -ne 0 ]; then
        # Initialize $HA_RES_NAMES
        ha_read_infile;
        ha_write_status_for_all_resources $HA_CMD_FAILED;
        ${HA_LOG} "Check if ha_ifd process is running"
        ${HA_LOG} "ha_ifadmin command failed to obtain current interface"
        exit_script $HA_CMD_FAILED;
    fi

    # Obtain new interface, netmask and broadcast address for ip
    # address from interface daemon.

    HA_CMD="${LOCAL_IFDADMIN} -g ${HA_INFILE} ${LOCAL_TMPFILE2_NEW}"
    ha_execute_cmd "obtaining a interface for the ip addresses"

    if [ $? -ne 0 ]; then
        # Initialize $HA_RES_NAMES. REVISIT: this is not correct. causes
        # duplicate entries in the files.
        ha_read_infile;
        ha_write_status_for_all_resources $HA_CMD_FAILED;
        ${HA_LOG} "Check if ha_ifd process is running"
        exit_script $HA_CMD_FAILED;
    fi

    # Read the new information returned by ha_ifdadmin command for the
    # ip addresses
    while read IPADDR_ENTRY
```



```

do
    set $IPADDR_ENTRY
    # $1 has IP address, $2 has interface name or "error"
    # $3 has netmask and $4 has broadcast address

    if [ "X$2" = "Xerror" ]; then
        ${HA_LOG} "no interface found for ip address $1";
        ${HA_LOG} "Check ha_ifd logs on this node for more information"
        IPADDR_FAILED=true;
        ha_write_status_for_resource $1 $HA_CMD_FAILED;
        continue;
    fi

    IP_ADDR=$1
    NEW_IF_NAME=$2
    NEW_IP_MASK=$3
    NEW_IP_BRDA=$4

    # Determine the old interface name for the ip address
    OLD_IF_NAME=`/usr/bin/awk -v ip_addr=$IP_ADDR '{ if ($1 == ip_addr) print $2 }' ${LOCAL_TMPFILE1_CURRENT}`

    # If the old interface is not found, continue. Otherwise delete
    # ip address from the old interface.

    if [ "X${OLD_IF_NAME}" = "Xerror" ]; then
        ${HA_LOG} "ip address ${IP_ADDR} not configured";
    elif [ "X${OLD_IF_NAME}" = "X" ]; then
        ${HA_LOG} "Could not figure out ip address ${IP_ADDR} configuration";
    else
        # Remove the IP address from the old interface
        HA_CMD="/usr/etc/ifconfig ${OLD_IF_NAME} delete ${IP_ADDR}"
        ha_execute_cmd "deleting ip address ${IP_ADDR}"

        if [ $? -ne 0 ]; then
            ${HA_LOG} "${HA_CMD} failed"
            ha_write_status_for_resource $IP_ADDR $HA_CMD_FAILED;
            continue;
        fi

        # Configuring the interface down so that we can start the
        # IP address on another interface in the node.

```

```
##### First Local IP Failover Modification Start

# Defining some variables

IFCONFIG=/usr/etc/ifconfig
ROUTE=/usr/etc/route
NSTAT="/usr/etc/netstat -nr"
GREP=/sbin/grep
AWK=/usr/bin/awk
QUIET=-q
CAP_NET="/sbin/suattr -C CAP_NETWORK_MGT+ip -c"
ROUTEOPT=/etc/config/static-route.options
ROUTEADD=/tmp/static_route_failsafe_add
ROUTEDEL=/tmp/static_route_failsafe_delete

# Saving gateways list for OLD_IF_NAME
# Need to be done before the interface is configured down

GWLIST="`$NSTAT|$GREP ${OLD_IF_NAME}|$AWK '{print $2}'|$GREP -v link`"

##### First Local IP Failover Modification End

echo $OLD_IF_NAME | /usr/bin/egrep "rns[0-9]+|xpi[0-9]+" > /dev/null
if [ $? -eq 0 ]; then
    HA_CMD="/usr/etc/smtconfig ${OLD_IF_NAME} down"
else
    HA_CMD="/usr/etc/ifconfig ${OLD_IF_NAME} down"
fi
ha_execute_cmd "Configuring interface ${OLD_IF_NAME} down"

if [ $? -ne 0 ]; then
    IPADDR_FAILED=true;
    ${HA_LOG} "${HA_CMD} failed"
    ha_write_status_for_resource $IP_ADDR $HA_CMD_FAILED;
    continue;
fi

##### Second Local IP Failover Modification Start

if [ "X${OLD_IF_NAME}" != "X${NEW_IF_NAME}" ]; then
```

```

# Saving interfaces settings

IFCONFIG_OPT_OLD=`$IFCONFIG ${OLD_IF_NAME}|$GREP inet| \
    /usr/bsd/head -1|/sbin/sed -e "s/inet/"`
IFCONFIG_OPT_NEW=`$IFCONFIG ${NEW_IF_NAME}|$GREP inet| \
    /usr/bsd/head -1|/sbin/sed -e "s/inet/"`

# Setting some variables:
# PRIM_BCAST and MCAST are used only if the interface
# OLD_IF_NAME is the primary interface

PRIM_BCAST=`$NSTAT|$GREP 255.255.255.255| $AWK '{print $2}'`
MCAST=`$NSTAT|$GREP 224|$GREP ${OLD_IF_NAME}|$AWK '{print $1}'`

# Creating static add/delete tables

for gateway in $GWLIST
do
    $GREP $gateway $ROUTEOPT >> $ROUTEADD
done
$GREP add $ROUTEADD |/sbin/sed -e "s/add/delete/" >> $ROUTEDEL

# Setting NEW_IF_NAME down

$IFCONFIG ${NEW_IF_NAME} down

# Deleting static routes set in static-route.options

. $ROUTEDEL

# Deleting multicast route if defined over OLD_IF_NAME

if [ X${MCAST} = "X224" ]; then
    $ROUTE delete -net 224 -netmask 240.0.0.0
fi

# Starting the interfaces with the new configuration
$IFCONFIG ${OLD_IF_NAME} ${IFCONFIG_OPT_NEW}
$IFCONFIG ${NEW_IF_NAME} ${IFCONFIG_OPT_OLD}

```

```
# Adding the static routes defined in static-route.options and
# flushing the arp table

. $ROUTEADD
/usr/etc/arp -c
/sbin/rm -f $ROUTEADD $ROUTEDEL

# Setting multicast route if previously deleted

if [ X${MCAST} = "X224" ]; then
    $ROUTE add -net 224 -interface $IP_ADDR -netmask 240.0.0.0
    $ROUTE change -ifa $IP_ADDR 255.255.255.255 $PRIM_BCAST
fi
fi

#### Second Local IP Failover Modification End

fi # Removed IP address from the old interface.

# Configure the interface up before adding the IP_ADDR. The interface
# might be configured down
echo $NEW_IF_NAME | /usr/bin/egrep "rns[0-9]+|xpi[0-9]+" > /dev/null
if [ $? -eq 0 ]; then
    HA_CMD="/usr/etc/smtconfig $NEW_IF_NAME up"
else
    echo $NEW_IF_NAME | /usr/bin/egrep "eg[0-9]+" > /dev/null
    if [ $? -eq 0 ]; then
        HA_CMD="/usr/etc/egconfig ${NEW_IF_NAME} && /usr/etc/ifconfig ${NEW_IF_NAME} up"
    else
        HA_CMD="/usr/etc/ifconfig ${NEW_IF_NAME} up"
    fi
fi
ha_execute_cmd "configuring interface ${NEW_IF_NAME} up"

if [ $? -ne 0 ]; then
    ha_write_status_for_resource $IP_ADDR $HA_CMD_FAILED;
    continue;
fi

HA_CMD="/usr/etc/ifconfig $NEW_IF_NAME alias $IP_ADDR netmask $NEW_IP_MASK"
ha_execute_cmd "configuring ip address ${IP_ADDR}"
```

```
if [ $? -ne 0 ]; then
    IPADDR_FAILED=true;
    ha_write_status_for_resource $IP_ADDR $HA_CMD_FAILED;
    continue;
fi

#
# Do not send arp packet for GSN interfaces
#
echo ${IF_NAME} | /usr/bin/egrep "gsn[0-9]+|hip[0-9]+|lb[0-9]+" > /dev/null
if [ $? -ne 0 ]; then
    echo ${IF_NAME} | /usr/bin/egrep "el[0-9]+" > /dev/null
    if [ $? -eq 0 ]; then
        sleep 5;
    fi
    HA_CMD="${HA_CMDSPATH}/ha_macconfig2 arp ${NEW_IF_NAME} ${IP_ADDR}"
    ha_execute_cmd "sending arp packet for ${IP_ADDR}"

    if [ $? -ne 0 ]; then
        IPADDR_FAILED=true;
        ha_write_status_for_resource $IP_ADDR $HA_CMD_FAILED;
        continue;
    fi
fi

ha_write_status_for_resource $IP_ADDR $HA_SUCCESS;

done < ${LOCAL_TMPFILE2_NEW}

#
# If there is no failure, remove local tmp files.
#
if [ X${IPADDR_FAILED} = "Xfalse" ]; then
    /sbin/rm -f ${LOCAL_TMPFILE1_CURRENT} ${LOCAL_TMPFILE2_NEW};
fi

#
# Restart autofsd so that it can read new IP aliases configuration
#
```

## 7: Configuration Examples

---

```
/sbin/killall -HUP autofs;  
}
```

## FailSafe System Operation

This chapter describes administrative tasks you perform to operate and monitor an FailSafe system. It describes how to perform tasks using the FailSafe Manager GUI and the `cmgr` command. The major sections in this chapter are as follows:

- "Redirecting the Console for Origin 300, Origin 3200C, Onyx 300, and Onyx 3200C"
- "Two-Node Clusters: Single-Node Use" on page 292
- "System Status" on page 297
- "Embedded Support Partner (ESP) Logging of FailSafe Events" on page 314
- "Resource Group Failover" on page 315
- "Stopping FailSafe" on page 322
- "Resetting Nodes" on page 322
- "Cluster Database Backup and Restore" on page 325
- "Rotating Log Files" on page 329
- "Granting Task Execution Privileges to Users" on page 330

---

**Note:** SGI recommends that you perform all FailSafe administration from one node in the pool so that the latest copy of the database will be available, even when there are network partitions.

---

### Redirecting the Console for Origin 300, Origin 3200C, Onyx 300, and Onyx 3200C

Use the following procedure to redirect the console, which is required to get access to the console input and output on systems with only one serial/USB port that provides both L1 system controller and console support:

1. Edit the `/etc/inittab` file to use an alternate serial port.
2. Either issue an `init q` command or reboot.

For example, suppose you had the following in the `/etc/inittab` file (line breaks added for readability):

```
# on-board ports or on Challenge/Onyx MP machines, first IO4 board ports
t1:23:respawn:/sbin/suattr -C CAP_FOWNER,CAP_DEVICE_MGT,CAP_DAC_WRITE+ip
-c "exec /sbin/getty ttyd1 console" # alt console
t2:23:off:/sbin/suattr -C CAP_FOWNER,CAP_DEVICE_MGT,CAP_DAC_WRITE+ip
-c "exec /sbin/getty -N ttyd2 co_9600" # port 2
```

You could change it to the following:

```
# on-board ports or on Challenge/Onyx MP machines, first IO4 board ports
t1:23:off:/sbin/suattr -C CAP_FOWNER,CAP_DEVICE_MGT,CAP_DAC_WRITE+ip
-c "exec /sbin/getty ttyd1 co_9600" # port 1
t2:23:respawn:/sbin/suattr -C CAP_FOWNER,CAP_DEVICE_MGT,CAP_DAC_WRITE+ip
-c "exec /sbin/getty -N ttyd2 console" # alt console
```



**Caution:** Redirecting the console by using the above method works only when IRIX is running. To access the console when IRIX is not running (miniroot), you must physically reconnect the machine: unplug the serial hardware reset cable from the console/L1 port and then connect the console cable.

---

For more information, see "Origin 300, Origin 3200C, Onyx 300, and Onyx 3200C Console Support" on page 78.

## Two-Node Clusters: Single-Node Use

This section discusses the procedure for using a single node in a two-node cluster in the following cases:

- Only one node in a cluster is powered up after a power failure
- One node in the cluster is down for an extended period for maintenance



## Using a Single Node

The following procedure describes the steps required to use just one node in the cluster:

1. Create an emergency failover policy for each node. Each policy should look like the following example when the `cmgr` command is issued, where *ActiveNode* is the name of the node using the policy (in the examples, `nodeA`) and *DownNode* is the name of the nonfunctioning node (in the examples, `nodeB`):

```
cmgr> show failover_policy emergency-ActiveNode

Failover Policy: emergency-ActiveNode
Version: 1
Script: ordered
Attributes: Controlled_Failback InPlace_Recovery
Initial AFD: ActiveNode
```

For example, suppose you have two nodes, `nodeA` and `nodeB`. You would have two emergency failover policies:

```
cmgr> show failover_policy emergency-nodeA

Failover Policy: emergency-nodeA
Version: 1
Script: ordered
Attributes: Controlled_Failback InPlace_Recovery
Initial AFD: nodeA
```

```
cmgr> show failover_policy emergency-nodeB

Failover Policy: emergency-nodeB
Version: 1
Script: ordered
Attributes: Controlled_Failback InPlace_Recovery
Initial AFD: nodeB
```

For more information, see "Define a Failover Policy" on page 223.

If a single node in a two-node cluster has just booted from a power failure and the other node is still powered off, the surviving node will form an active cluster. The resources will be in `ONLINE READY` state. They cannot move to `ONLINE` state because only half of the failover domain is active. The powered-off node

will be in UNKNOWN state. At this point, you would want to apply the emergency policy, which contains only one node in the failover domain.

---

**Note:** If the nonfunctional node is in DOWN state (because it was reset by another node), then the resource groups will be in the ONLINE state rather than ONLINE READY state.

---

2. Change the state of all resource groups to `offline`. The last known state of these groups was `online` before the machines went down. This step tells the database to label the state of the resource groups appropriately in preparation for later steps. FailSafe will execute the new failover policy when the groups are made `online`.

---

**Note:** If the groups are already `online` on the surviving node (such as they would be in a maintenance procedure), you should use the `admin offline_detach` command rather than the `admin offline_force` command because the desire is to leave all resources running on that surviving node.

---

Use the following command:

```
admin offline_force resource_group RGname in cluster Clustername
```

For example:

```
cmgr> set cluster test-cluster
cmgr> show resource_groups in test-cluster
```

```
Resource Groups:
    group1
    group2
```

```
cmgr> admin offline_force resource_group group1
cmgr> admin offline_force resource_group group2
```

3. Modify each resource group to use the appropriate single-node emergency failover policy (the policy that contains the one node that is up). Use the following `cmgr` commands or the GUI:

```
modify resource_group RGname in cluster Clustername
set failover_policy to emergency-ActiveNode
```

For example, on nodeA:

```
cmgr> set cluster test-cluster
cmgr> modify resource_group group1
Enter commands, when finished enter either "done" or "cancel"

resource_group group1 ? set failover_policy to emergency-nodeA
resource_group group1 ? done
Successfully modified resource group group1
```

4. Mark the resource groups as online in the database. When HA services are started in future steps, the services will come online using the emergency failover policies.

```
admin online resource_group RGname in cluster Clustername
```

For example:

```
cmgr> set cluster test-cluster
cmgr> admin online resource_group group1
FailSafe daemon (ha_fsd) is not running on this local node or it is not ready to accept admin commands.
Resource Group (group1) is online-ready.
```

```
Failed to admin:
    online
```

```
admin command failed
```

```
cmgr> show status of resource_group group1 in cluster test-cluster
```

```
State: Online Ready
Error: No error
Check resource group group1 status in an active node if HA services are active in cluster
```

## Resuming Two-Node Use

To resume using the down node, do the following:

1. Boot the down node. It will join the cluster and copy the cluster database from the other node.
2. Perform an `offline_detach` command on the resource groups in the cluster. This causes FailSafe to stop monitoring the resource group, but does not physically

stop the processes on that group. FailSafe will report the status as offline and will not have any control over the group. The resources will remain in service.

---

**Note:** There are issues when performing an `offline_detach` operation with `Auto_Recovery`; see "Offline Detach Issues" on page 75.

---

Use the following command:

```
admin offline_detach resource_group RGname [in cluster Clustername]
```

For example:

```
cmgr> admin offline_detach resource_group group1 in cluster test-cluster
```

Show the status of the resource groups to be sure that they now show as offline.

---

**Note:** The resources are still in service even though this command output shows them as offline.

---

```
show status of resource_group RGname in cluster Clustername
```

For example:

```
cmgr> show status of resource_group group1 in cluster test-cluster
```

3. Modify the resource groups to restore the original two-node failover policies they were using before the failure:

```
modify resource_group RGname in cluster Clustername  
set failover_policy to OriginalFailoverPolicy
```

---

**Note:** This only restores the configuration for the static environment. The runtime environment will still be using the single-node policy at this time.

---

For example, if the normal failover policy was `normal-fp`:

```
cmgr> set cluster test-cluster  
cmgr> modify resource_group group1  
Enter commands, when finished enter either "done" or "cancel"
```

```
resource_group group1 ? set failover_policy to normal-fp  
resource_group group1 ? done  
Successfully modified resource group group1
```

```
cmgr modify resource_group group2  
Enter commands, when finished enter either "done" or "cancel"
```

```
resource_group group2 ? set failover_policy to normal-fp  
resource_group group2 ? done  
Successfully modified resource group group2
```

4. Make the resource groups online in the cluster:

```
admin online resource_group RGname in cluster Clustername
```

For example:

```
cmgr> admin online resource_group group1 in cluster test-cluster  
cmgr> admin online resource_group group2 in cluster test-cluster
```

5. It may be desirable to move the resources back to their original nodes if it is believed that the cluster is now healthy. (Because our original policies included the `InPlace_Recovery` attribute, all of the resources have remained on the node that has been active throughout this process.)

```
admin move resource_group RGname in cluster Clustername to node PrimaryOwner
```

For example:

```
cmgr> admin move resource_group group1 in cluster test-cluster to node nodeB
```

If you run into errors after entering the `admin move` command, see "Ensuring that Resource Groups are Deallocated" on page 351.

## System Status

This section describes the following:

- "Monitoring System Status with `cluster_status`" on page 298
- "Monitoring System Status with the GUI" on page 299

- "Key to Icons and States" on page 300
- "Querying Cluster Status with cmgr" on page 302
- "Monitoring Resource and Reset Serial Line with cmgr" on page 302
- "Resource Group Status" on page 303
- "Node Status" on page 307
- "Viewing System Status with the haStatus Script" on page 308

### Monitoring System Status with cluster\_status

You can use the `cluster_status` command to monitor the cluster using a curses interface. For example, the following shows a two-node cluster configured for FailSafe only and `cluster_status` help text displayed:

```
# /var/cluster/cmgr-scripts/cluster_status
* Cluster=nfs-cluster FailSafe=ACTIVE CXFS=Not Configured 08:45:12
  Nodes =      hans2      hans1
  FailSafe =    UP        UP
FailSafe HB =192.26.50.15 127.0.0.1
  CXFS =
  ResourceGroup      Owner      State      Error
  bartest-group      Offline  No error
  footest-group      Offline  No error
    bar_rg2          hans2    Online    No error
    nfs-group1       hans2    Online    No error
    foo_rg           hans2    Online    No error
```

```
+-----+ cluster_status Help +-----+
| on s - Toggle Sound on event |
| on r - Toggle Resource Group View |
| on c - Toggle CXFS View |
| j - Scroll up the selection |
| k - Scroll down the selection |
| TAB - Toggle RG or CXFS selection |
| ENTER - View detail on selection |
| h - Toggle help screen |
```

```
|      q - Quit cluster_status      |  
+--- Press 'h' to remove help window ---+
```

The above shows that a sound will be activated when a node or the cluster changes status. You can override the `s` setting by invoking `cluster_status` with the `-m` (mute) option. You can also use the arrow keys to scroll the selection.

---

**Note:** The `cluster_status` command can display no more than 128 CXFS filesystems.

---

## Monitoring System Status with the GUI

The easiest way to keep a continuous watch on the state of a cluster is to use the GUI view area.

System components that are experiencing problems appear as blinking red icons. Components in transitional states also appear as blinking icons. If there is a problem in a resource group or node, the icon for the cluster turns red and blinks, as well as the resource group or node icon.

The cluster status can be one of the following:

- **ACTIVE**, which means the cluster is up and running and there is a valid FailSafe membership.
- **INACTIVE**, which means the start FailSafe HA services task has not been run and there is no FailSafe membership.
- **ERROR**, which means that some nodes are in a **DOWN** state; that is, the cluster **should** be running, but it is not.
- **UNKNOWN**, which means that the state cannot be determined because FailSafe HA services are not running on the node performing the query.







If you minimize the GUI window, the minimized-icon shows the current state of the cluster. Green indicates FailSafe HA services active without an error, gray indicates FailSafe HA services are inactive, and red indicates an error state.

### Key to Icons and States





The following tables show keys to the icons and states used in the FailSafe Manager GUI.

The full legend for component states is as follows:



**Table 8-1** Key to Icons





Icon	Entity
	IRIX node
	Cluster
	Resource
	Resource group
	Resource type
	Failover policy



Icon	Entity
	Expanded tree
	Collapsed tree
	User name
	GUI task for which execution privilege may be granted or revoked
	Privileged command executed by a given GUI task

**Table 8-2** Key to States

Icon	State
	Inactive or unknown (HA services may not be active)
	Online-ready state for a resource group

Icon	State
	Healthy and active or online
	(blinking) Transitioning to healthy and active/online or transitioning to offline
	Maintenance mode, in which the resource is not monitored by FailSafe
	(blinking red) Problems with the component

### Querying Cluster Status with `cmgr`

To query node and cluster status, use the following command:

```
show status of cluster Clustername
```

### Monitoring Resource and Reset Serial Line with `cmgr`

You can use `cmgr` to query the status of a resource or to contact the system controller on a node, as described in the following subsections.

#### Querying Resource Status with `cmgr`

To query a resource status, use the following command:

```
show status of resource Resourcename of resource_type RTname [in cluster Clustername]
```

If you have specified a default cluster, you do not need to specify a cluster when you use this command and it will show the status of the indicated resource in the default cluster.

This command displays the number of local monitoring failures, the monitor execution time parameters, and the maximum and minimum time taken to complete the monitoring script for the resource. For example, the following output shows that there have been no local monitoring failures:

```
cmgr> show status of resource 163.154.18.119 of resource_type IP_address in cluster nfs-cluster
```

```
State: Online
Error: None
Owner: hans2
Flags: Resource is monitored locally
Resource statistics
  Number of local monitoring failures: 0
  Time of last local monitoring failure: Not applicable
  Total number of monitors 885
  Maximum monitor execution time 998
  Minimum monitor execution time 155
  Last monitor execution time 222
  Monitor timeout 40000
  All times are in milliseconds
```

### Performing a ping of a System Controller with `cmgr`

To perform a ping operation on a system controller by providing the device name, use the following command:

```
admin ping dev_name devicename of dev_type tty with sysctrl_type SystemControllerType
```

## Resource Group Status

To query the status of a resource group, you provide the name of the resource group and the cluster which includes the resource group. Resource group status includes the following components:

- Resource group state
- Resource group error state
- Resource owner

These components are described in the following subsections.

If a node that contains a resource group online has a status of UNKNOWN, the status of the resource group will not be available or ONLINE-READY.

### Resource Group State

A resource group state can be one of the following:

ONLINE	FailSafe is running on the local nodes. The resource group is allocated on a node in the cluster and is being monitored by FailSafe. It is fully allocated if there is no error; otherwise, some resources may not be allocated or some resources may be in an error state.
ONLINE-PENDING	FailSafe is running on the local nodes and the resource group is in the process of being allocated. This is a transient state.
OFFLINE	The resource group is not running or the resource group has been detached, regardless of whether FailSafe is running. When FailSafe starts up, it will not allocate this resource group.
OFFLINE-PENDING	FailSafe is running on the local nodes and the resource group is in the process of being released (becoming offline). This is a transient state.
ONLINE-READY	FailSafe is not running on the local node. When FailSafe starts up, it will attempt to bring this resource group online. No FailSafe process is running on the current node if this state is returned.
ONLINE-MAINTENANCE	The resource group is allocated in a node in the cluster but it is not being monitored by FailSafe. If a node failure occurs while a resource group in ONLINE-MAINTENANCE state resides on that node, the resource group will be moved to another node and monitoring will resume. An administrator may move a resource group to an ONLINE-MAINTENANCE state for upgrade or testing purposes, or if there is any reason that FailSafe should not act on that resource for a period of time.
INTERNAL ERROR	An internal FailSafe error has occurred and FailSafe does not know the state of the resource group. Error

	recovery is required. This could result from a memory error, bugs in a program, or communication problems.
DISCOVERY ( EXCLUSIVITY )	The resource group is in the process of going online if FailSafe can correctly determine whether any resource in the resource group is already allocated on all nodes in the resource group's failover domain. This is a transient state.
INITIALIZING	FailSafe on the local node has yet to get any information about this resource group. This is a transient state.

### Resource Group Error State

When a resource group is ONLINE, its error status is continually being monitored. A resource group error status can be one of the following:

NO ERROR	Resource group has no error.
INTERNAL ERROR - NOT RECOVERABLE	An internal error occurred; notify SGI if this condition arises.
NODE UNKNOWN	Node that had the resource group online is in an unknown state. This occurs when the node is not part of the cluster. The last known state of the resource group is ONLINE, but the system cannot communicate with the node.
SRMD EXECUTABLE ERROR	The start or stop action has failed for a resource in the resource group.
SPLIT RESOURCE GROUP ( EXCLUSIVITY )	FailSafe has determined that part of the resource group was running on at least two different nodes in the cluster.
NODE NOT AVAILABLE ( EXCLUSIVITY )	FailSafe has determined that one of the nodes in the resource group's failover domain was not in the FailSafe membership. FailSafe cannot bring the resource group online until that node is removed from the failover domain or HA services are started on that node.
MONITOR ACTIVITY UNKNOWN	In the process of turning maintenance mode on or off, an error occurred. FailSafe can no longer determine if monitoring is enabled or disabled. Retry the operation. If the error continues, report the error to SGI.

NO AVAILABLE NODES

A monitoring error has occurred on the last valid node in the FailSafe membership.

### Resource Owner

The resource owner is the logical node name of the node that currently owns the resource.

### Monitoring Resource Group Status with GUI

You can use the view area to monitor the status of the resources in a FailSafe configuration:

- Select **View: Resources in Groups** to see the resources organized by the groups to which they belong.
- Select **View: Groups owned by Nodes** to see where the online groups are running. This view lets you observe failovers as they occur.

### Querying Resource Group Status with `cmgr`

To query a resource group status, use the following `cmgr` command:

```
show status of resource_group RGname [in cluster Clustername]
```

If you have specified a default cluster, you do not need to specify a cluster when you use this command and it will show the status of the indicated resource group in the default cluster.

## Node Status

To query the status of a node, you provide the logical node name of the node. The node status can be one of the following:

UP	This node is part of the FailSafe membership.
DOWN	This node is not part of the FailSafe membership (no heartbeats) and this node has been reset. This is a transient state.
UNKNOWN	This node is not part of the FailSafe membership (no heartbeats) and this node has not been reset (reset attempt has failed).
INACTIVE	HA services have not been started on this node.

When you start HA services, node states transition from `INACTIVE` to `UP`. It may happen that a node state may transition from `INACTIVE` to `UNKNOWN` to `UP`.

### Monitoring Node Status with `cluster_status`

You can use the `cluster_status` command to monitor the status of the nodes in the cluster.

### Monitoring Cluster Status with the GUI

You can use the GUI view area to monitor the status of the clusters in a FailSafe configuration. Select **View: Groups owned by Nodes** to monitor the health of the default cluster, its resource groups, and the group's resources.

### Querying Node Status with `cmgr`

To query node status, use the following command:

```
show status of node nodename
```

### Performing a ping of the System Controller with `cmgr`

When FailSafe is running, you can determine whether the system controller on a node is responding with the following command:

```
admin ping node nodename
```

This command uses the FailSafe daemons to test whether the system controller is responding.

You can verify reset connectivity on a node in a cluster even when the FailSafe daemons are not running by using the standalone option of the `admin ping` command:

```
admin ping standalone node nodename
```

This command does not go through the FailSafe daemons, but calls the `ping` command directly to test whether the system controller on the indicated node is responding.

## Viewing System Status with the `haStatus` Script

The `haStatus` script provides status and configuration information about clusters, nodes, resources, and resource groups in the configuration. This script is installed in the `/var/cluster/cmgr-scripts` directory. You can modify this script to suit your needs. See the `haStatus` man page for further information about this script.

The following examples show the output of the different options of the `haStatus` script.

```
# haStatus -help
Usage: haStatus [-a|-i] [-c clustername]
where,
  -a prints detailed cluster configuration information and cluster
  status.
  -i prints detailed cluster configuration information only.
  -c can be used to specify a cluster for which status is to be printed.
  ``clustername`` is the name of the cluster for which status is to be
  printed.

# haStatus
Tue Nov 30 14:12:09 PST 1999
Cluster test-cluster:
    Cluster state is ACTIVE.
Node hans2:
    State of machine is UP.
Node hans1:
    State of machine is UP.
Resource_group nfs-group1:
```



```
State: Online
Error: No error
Owner: hans1
Failover Policy: fp_h1_h2_ord_auto_auto
Resources:
    /hafs1 (type: NFS)
    /hafs1/nfs/statmon (type: statd_unlimited)
    150.166.41.95 (type: IP_address)
    /hafs1 (type: filesystem)
    havoll (type: volume)

# haStatus -i
Tue Nov 30 14:13:52 PST 1999
Cluster test-cluster:
Node hans2:
    Logical Machine Name: hans2
    Hostname: hans2.dept.company.com
    Is FailSafe: true
    Is CXFS: false
    Nodeid: 32418
    Reset type: powerCycle
    System Controller: msc
    System Controller status: enabled
    System Controller owner: hans1
    System Controller owner device: /dev/ttyd2
    System Controller owner type: tty
    ControlNet Ipaddr: 192.26.50.15
    ControlNet HB: true
    ControlNet Control: true
    ControlNet Priority: 1
    ControlNet Ipaddr: 150.166.41.61
    ControlNet HB: true
    ControlNet Control: false
    ControlNet Priority: 2
Node hans1:
    Logical Machine Name: hans1
    Hostname: hans1.dept.company.com
    Is FailSafe: true
    Is CXFS: false
    Nodeid: 32645
    Reset type: powerCycle
    System Controller: msc
```

```
System Controller status: enabled
System Controller owner: hans2
System Controller owner device: /dev/ttyd2
System Controller owner type: tty
ControlNet Ipaddr: 192.26.50.14
ControlNet HB: true
ControlNet Control: true
ControlNet Priority: 1
ControlNet Ipaddr: 150.166.41.60
ControlNet HB: true
ControlNet Control: false
ControlNet Priority: 2
Resource_group nfs-group1:
  Failover Policy: fp_h1_h2_ord_auto_auto
  Version: 1
  Script: ordered
  Attributes: Auto_Failback Auto_Recovery
  Initial AFD: hans1 hans2
Resources:
  /hafsl (type: NFS)
  /hafsl/nfs/statmon (type: statd_unlimited)
  150.166.41.95 (type: IP_address)
  /hafsl (type: filesystem)
  havoll (type: volume)
Resource /hafsl (type NFS):
  export-info: rw,wsync
  filesystem: /hafsl
  Resource dependencies
  statd_unlimited /hafsl/nfs/statmon
  filesystem /hafsl
Resource /hafsl/nfs/statmon (type statd_unlimited):
  InterfaceAddress: 150.166.41.95
  Resource dependencies
  IP_address 150.166.41.95
  filesystem /hafsl
Resource 150.166.41.95 (type IP_address):
  NetworkMask: 0xffffffff00
  interfaces: ef1
  BroadcastAddress: 150.166.41.255
  No resource dependencies
Resource /hafsl (type filesystem):
```

```
        volume-name: havoll
        mount-options: rw,noauto
        monitor-level: 2
        Resource dependencies
        volume havoll
Resource havoll (type volume):
    devname-group: sys
    devname-owner: root
    devname-mode: 666
    No resource dependencies
Failover_policy fp_h1_h2_ord_auto_auto:
    Version: 1
    Script: ordered
    Attributes: Auto_Failback Auto_Recovery
    Initial AFD: hans1 hans2
# haStatus -a
Tue Nov 30 14:45:30 PST 1999
Cluster test-cluster:
    Cluster state is ACTIVE.
Node hans2:
    State of machine is UP.
    Logical Machine Name: hans2
    Hostname: hans2.dept.company.com
    Is FailSafe: true
    Is CXFS: false
    Nodeid: 32418
    Reset type: powerCycle
    System Controller: msc
    System Controller status: enabled
    System Controller owner: hans1
    System Controller owner device: /dev/ttyd2
    System Controller owner type: tty
    ControlNet Ipaddr: 192.26.50.15
    ControlNet HB: true
    ControlNet Control: true
    ControlNet Priority: 1
    ControlNet Ipaddr: 150.166.41.61
    ControlNet HB: true
    ControlNet Control: false
    ControlNet Priority: 2
Node hans1:
```

```
State of machine is UP.
Logical Machine Name: hans1
Hostname: hans1.dept.company.com
Is FailSafe: true
Is CXFS: false
Nodeid: 32645
Reset type: powerCycle
System Controller: msc
System Controller status: enabled
System Controller owner: hans2
System Controller owner device: /dev/ttyd2
System Controller owner type: tty
ControlNet Ipaddr: 192.26.50.14
ControlNet HB: true
ControlNet Control: true
ControlNet Priority: 1
ControlNet Ipaddr: 150.166.41.60
ControlNet HB: true
ControlNet Control: false
ControlNet Priority: 2
Resource_group nfs-group1:
  State: Online
  Error: No error
  Owner: hans1
  Failover Policy: fp_h1_h2_ord_auto_auto
  Version: 1
  Script: ordered
  Attributes: Auto_Failback Auto_Recovery
  Initial AFD: hans1 hans2
Resources:
  /hafs1 (type: NFS)
  /hafs1/nfs/statmon (type: statd_unlimited)
  150.166.41.95 (type: IP_address)
  /hafs1 (type: filesystem)
  havoll (type: volume)
Resource /hafs1 (type NFS):
  State: Online
  Error: None
  Owner: hans1
  Flags: Resource is monitored locally
  export-info: rw,wsync
```

```
filesystem: /hafs1
Resource dependencies
statd_unlimited /hafs1/nfs/statmon
filesystem /hafs1
Resource /hafs1/nfs/statmon (type statd_unlimited):
State: Online
Error: None
Owner: hans1
Flags: Resource is monitored locally
InterfaceAddress: 150.166.41.95
Resource dependencies
IP_address 150.166.41.95
filesystem /hafs1
Resource 150.166.41.95 (type IP_address):
State: Online
Error: None
Owner: hans1
Flags: Resource is monitored locally
NetworkMask: 0xffffffff00
interfaces: ef1
BroadcastAddress: 150.166.41.255
No resource dependencies
Resource /hafs1 (type filesystem):
State: Online
Error: None
Owner: hans1
Flags: Resource is monitored locally
volume-name: havoll
mount-options: rw,noauto
monitor-level: 2
Resource dependencies
volume havoll
Resource havoll (type volume):
State: Online
Error: None
Owner: hans1
Flags: Resource is monitored locally
devname-group: sys
devname-owner: root
devname-mode: 666
No resource dependencies
```

```
# haStatus -c test-cluster
Tue Nov 30 14:42:04 PST 1999
Cluster test-cluster:
    Cluster state is ACTIVE.
Node hans2:
    State of machine is UP.
Node hans1:
    State of machine is UP.
Resource_group nfs-group1:
    State: Online
    Error: No error
    Owner: hans1
    Failover Policy: fp_h1_h2_ord_auto_auto
    Resources:
        /hafs1 (type: NFS)
        /hafs1/nfs/statmon (type: statd_unlimited)
        150.166.41.95 (type: IP_address)
        /hafs1 (type: filesystem)
        havoll (type: volume)
```

## Embedded Support Partner (ESP) Logging of FailSafe Events

The Embedded Support Partner (ESP) consists of a set of daemons that perform various monitoring activities. You can choose to configure ESP so that it will log FailSafe events (the FailSafe ESP event profile is not configured in ESP by default).

FailSafe uses an event class ID of 77 and a description of IRIS FailSafe2.

If you want to use ESP for FailSafe, enter the following command to add the `failsafe2` event profile to ESP:

```
# espconfig -add eventprofile failsafe2
```

FailSafe will then log ESP events for the following:

- Daemon configuration error
- Failover policy configuration error
- Resource group allocation (`start`) failure

- Resource group failures:
  - Allocation (`start`) failure
  - Release (`stop`) failure
  - Monitoring failure
  - Exclusivity failure
  - Failover policy failure
- Resource group status:
  - `online`
  - `offline`
  - `maintenance_on`
  - `maintenance_off`
- FailSafe shutdown (HA services stopped)
- FailSafe started (HA services started)

You can use the `espreport` or `launchESPartner` commands to see the logged ESP events. See the `esp` man page and the *Embedded Support Partner User Guide* for more information about ESP.

## Resource Group Failover

While a FailSafe system is running, you can move a resource group online to a particular node, or you can take a resource group offline. In addition, you can move a resource group from one node in a cluster to another node in a cluster. The following subsections describe these tasks.

### Bring a Resource Group Online

This section describes how to bring a resource group online.

### Bring a Resource Group Online with the GUI

Before you bring a resource group online for the first time, you should run the diagnostic tests on that resource group. Diagnostics check system configurations and perform some validations that are not performed when you bring a resource group online.

You cannot bring a resource group online in the following circumstances:

- If the resource group has no members
- If the resource group is currently running in the cluster

To bring a resource group fully online, HA services must be active. When HA services are active, an attempt is made to allocate the resource group in the cluster. However, you can also execute a command to bring the resource group online when HA services are not active. When HA services are not active, the resource group is marked to be brought online when HA services become active; the resource group is then in an `ONLINE-READY` state. Failsafe tries to bring a resource group in an `ONLINE-READY` state online when HA services are started.

You can disable resource groups from coming online when HA services are started by using the GUI or `cmgr` to take the resource group offline, as described in "Take a Resource Group Offline" on page 317.



**Caution:** Before bringing a resource group online in the cluster, you must be sure that the resource group is not running on a disabled node (where HA services are not running). Bringing a resource group online while it is running on a disabled node could cause data corruption. For information on detached resource groups, see "Take a Resource Group Offline" on page 317.

---

Do the following:

1. **Group to Bring Online:** select the name of the resource group you want to bring online. The menu displays only resource groups that are not currently online.
2. Click on **OK** to complete the task.

### Bring a Resource Group Online with `cmgr`

To bring a resource group online, use the following command:

```
admin online resource_group RGname [in cluster Clustername]
```



If you have specified a default cluster, you do not need to specify a cluster when you use this command.

For example:

```
cmgr> set cluster test-cluster
cmgr> admin online resource_group group1
FailSafe daemon (ha_fsd) is not running on this local node or it is not ready to accept admin commands.
Resource Group (group1) is online-ready.
```

```
Failed to admin:
    online
```

```
admin command failed
```

```
cmgr> show status of resource_group group1 in cluster test-cluster
```

```
State: Online Ready
```

```
Error: No error
```

```
Check resource group group1 status in an active node if HA services are active in cluster
```

## Take a Resource Group Offline

This section tells you how to take a resource group offline.

### Take a Resource Group Offline with the GUI

When you take a resource group offline, FailSafe takes each resource in the resource group offline in a predefined order. If any single resource gives an error during this process, the process stops, leaving all remaining resources allocated.

You can take a FailSafe resource group offline in any of the following ways:

- Take the resource group offline. This physically stops the processes for that resource group and does not reset any error conditions. If this operation fails, the resource group will be left online in an error state.
- Force the resource group offline. This physically stops the processes for that resource group but resets any error conditions. This operation cannot fail.
- Detach the resource group. This causes FailSafe to stop monitoring the resource group, but does not physically stop the processes on that group. FailSafe will

report the status as offline and will not have any control over the group. This operation should rarely fail.

- Detach the resource group and force the error state to be cleared. This causes FailSafe to stop monitoring the resource group, but does not physically stop the processes on that group. FailSafe will report the status as offline and will not have any control over the group. In addition, all error conditions of the resource group will be reset. This operation should rarely fail.

If you do not need to stop the resource group and do not want FailSafe to monitor the resource group while you make changes, but you would still like to have administrative control over the resource group (for instance, to move that resource group to another node), you can put the resource group in maintenance mode using the **Suspend Monitoring a Resource Group** task on the GUI or the `admin maintenance_on` command of `cmgr`, as described in "Suspend and Resume Monitoring of a Resource Group" on page 320.

If the `fsd` daemon is not running or is not ready to accept client requests, executing this task disables the resource group in the cluster database only. The resource group remains online and the command fails.

Enter the following:

1. **Detach Only:** check this box to stop monitoring the resource group. The resource group will not be stopped, but FailSafe will not have any control over the group.
2. **Detach Force:** check this box to stop monitoring the resource group. The resource group will not be stopped, but FailSafe will not have any control over the group. In addition, Failsafe will clear all errors.



**Caution:** The **Detach Only** and **Detach Force** settings leave the resource group's resources running on the node where the group was online. After stopping HA services on that node, do not bring the resource group online on another node in the cluster; doing so can cause data integrity problems. Instead, make sure that no resources are running on a node before stopping HA services on that node.

---

3. **Force Offline:** check this box to stop all resources in the group and clear all errors.
4. **Group to Take Offline:** select the name of the resource group you want to take offline. The menu displays only resource groups that are currently online.
5. Click on **OK** to complete the task.

### Take a Resource Group Offline with `cmgr`

To take a resource group offline, use the following command:

```
admin offline resource_group RGname [in cluster Clustername]
```

To take a resource group offline with the `force` option in effect, forcing FailSafe to complete the action even if there are errors, use the following command:

```
admin offline_force resource_group RGname [in cluster Clustername]
```

---

**Note:** Doing an `offline_force` operation on a resource group can leave resources in the resource group running on the cluster. The `offline_force` operation will succeed even though all resources in the resource group have not been stopped. FailSafe does not track these resources any longer. You should take care to prevent resources from running on multiple nodes in the cluster.

---

To detach a resource group, use the following command:

```
admin offline_detach resource_group RGname [in cluster Clustername]
```

To detach the resource group and force the error state to be cleared:

```
admin offline_detach_force resource_group RGname [in cluster Clustername]
```

This causes FailSafe to stop monitoring the resource group, but does not physically stop the processes on that group. FailSafe will report the status as offline and will not have any control over the group. In addition, all error conditions of the resource group will be reset. This operation should rarely fail.

### Move a Resource Group

This section tells you how to move a resource group.

#### Move a Resource Group with the GUI

While FailSafe is active, you can move a resource group to another node in the same cluster.

---

**Note:** When you move a resource group in an active system, you may find the unexpected behavior that the command appears to have succeeded, but the resource group remains online on the same node in the cluster. This can occur if the resource group fails to start on the node to which you are moving it. In this case, FailSafe will fail over the resource group to the next node in the application failover domain, which may be the node on which the resource group was originally running. Since FailSafe kept the resource group online, the command succeeds.

---

Enter the following:

1. **Group to Move:** select the name of the resource group to be moved. Only resource groups that are currently online are displayed in the menu.
2. **Failover Domain Node:** (*optional*) select the name of the node to which you want to move the resource group. If you do not specify a node, FailSafe will move the resource group to the next available node in the failover domain.
3. Click on **OK** to complete the task.

### Move a Resource Group with `cmgr`

To move a resource group to another node, use the following command:

```
admin move resource_group RGname [in cluster Clustername] [to node Nodename]
```

For example, to move resource group `nfs-group1` running on node `primary` to node `backup` in the cluster `nfs-cluster`, do the following:

```
cmgr> admin move resource_group nfs-group1 in cluster nfs-cluster to node backup
```

If the user does not specify the node, the resource group's failover policy is used to determine the destination node for the resource group.

If you run into errors after entering the `admin move` command, see "Ensuring that Resource Groups are Deallocated" on page 351.

### Suspend and Resume Monitoring of a Resource Group

This section describes how to stop monitoring of a resource group in order to put it into maintenance mode.

## Suspend Monitoring a Resource Group with the GUI

You can temporarily stop FailSafe from monitoring a specific resource group, which puts the resource group in maintenance mode. The resource group remains on the same node in the cluster but is no longer monitored by FailSafe for resource failures.

You can put a resource group into maintenance mode if you do not want FailSafe to monitor the group for a period of time. You may want to do this for upgrade or testing purposes, or if there is any reason that FailSafe should not act on that resource group. When a resource group is in maintenance mode, it is not being monitored and it is not highly available. If the resource group's owner node fails, FailSafe will move the resource group to another node and resume monitoring.

When you put a resource group into maintenance mode, resources in the resource group are in `ONLINE-MAINTENANCE` state. The `ONLINE-MAINTENANCE` state for the resource is seen only on the node that has the resource online. All other nodes will show the resource as `ONLINE`. The resource group, however, should appear as being in `ONLINE-MAINTENANCE` state in all nodes.

Do the following:

1. **Group to Stop Monitoring:** select the name of the group you want to stop monitoring. Only those resource groups that are currently online and monitored are displayed in the menu.
2. Click **OK** to complete the task.

## Resume Monitoring of a Resource Group with the GUI

This task lets you resume monitoring a resource group.

Once monitoring is resumed and assuming that the restart action is enabled, if the resource group or one of its resources fails, FailSafe will restart each failed component based on the failover policy.

Perform the following steps:

1. **Group to Start Monitoring:** select the name of the group you want to start monitoring. Only those resource groups that are currently online and not monitored are displayed in the menu.
2. Click **OK** to complete the task.

### Putting a Resource Group into Maintenance Mode with `cmgr`

To put a resource group into maintenance mode, use the following command:

```
admin maintenance_on resource_group RGname [in cluster Clustername]
```

If you have specified a default cluster, you do not need to specify a cluster when you use this command.

### Resume Monitoring of a Resource Group with `cmgr`

To move a resource group back online from maintenance mode, use the following command:

```
admin maintenance_off resource_group RGname [in cluster Clustername]
```

## Stopping FailSafe

You can stop the execution of FailSafe on all the nodes in a cluster or on a specified node only. See "Stop FailSafe HA Services" on page 241.

## Resetting Nodes

You can use FailSafe to reset nodes in a cluster. This sends a reset command to the system controller port on the specified node. When the node is reset, other nodes in the cluster will detect this and remove the node from the active cluster, reallocating any resource groups that were allocated on that node onto a backup node. The backup node that is used depends on how you have configured your system.

After the node reboots, it will rejoin the cluster. Some resource groups might move back to the node, depending on how you have configured your system.

### Reset a Node with the GUI

You can use the GUI to reset nodes in a cluster. This sends a reset command to the system controller port on the specified node. When the node is reset, other nodes in the cluster will detect the change and remove the node from the active cluster. When the node reboots, it will rejoin the FailSafe membership.

To reset a node, do the following:

1. **Node to Reset:** select the node to be reset.
2. Click on **OK** to complete the task.

### Reset a Node with `cmgr`

When FailSafe is running, you can reset a node with the following command:

```
admin reset node nodename
```

This command uses the FailSafe daemons to reset the specified node.

You can reset a node in a cluster even when the FailSafe daemons are not running by using the `standalone` option:

```
admin reset standalone node nodename
```

The command above does not use the `crsd` daemon.

If you have defined the node but have not defined system controller information for it, you can use the following command line:

```
admin reset dev_name nodename of dev_type tty with sysctrl_type mssc|mmsc|l2|l1
```

### Power Cycle a Node with `cmgr`

When FailSafe is running, you can perform a power cycle on a node with the following command:

```
admin powerCycle node nodename
```

This command uses the FailSafe daemons to powercycle the specified node.

You can powercycle a node in a cluster even when the FailSafe daemons are not running by using the `standalone` option:

```
admin powerCycle standalone node nodename
```

This command does not go through the `crsd` daemon.

If the node has not been defined in the cluster database, you can use the following command line:

```
admin powerCycle dev_name nodename of dev_type tty with sysctrl_type msc|mmsc|l2|l1
```

### Perform an NMI on a Node with cmgr

When FailSafe is running, you can perform a nonmaskable interrupt (NMI) on a node with the following command:

```
admin nmi node nodename
```

This command uses the FailSafe daemons to perform an NMI on the specified node.

You can perform an NMI on a node in a cluster even when the FailSafe daemons are not running by using the `standalone` option:

```
admin nmi standalone node nodename
```

The above command does not use the `crsd` daemon.

If the node has not been defined in the cluster database, you can use the following command line:

```
admin nmi dev_name nodename of dev_type tty with sysctrl_type msc|mmsc|l2|l1
```



## Cluster Database Backup and Restore

This section discusses the following:

- "Restoring the Database from Another Node"
- "Using `build_cmgr_script` for the Cluster Database"
- "Using `cdbBackup` and `cdbRestore` for the Cluster Database and Logging Information" on page 327

### Restoring the Database from Another Node

If the database has been accidentally deleted from an individual node, you can replace it with a copy from another node. Do not use this method if the cluster database has been corrupted.

Do the following:

1. Stop the HA services and (if running) CXFS services.
2. Stop the cluster daemons by running the following command on each node:  

```
# /etc/init.d/cluster stop
```
3. Run `cdbreinit` on nodes that are missing the cluster database. Verify that cluster daemons are running.
4. Restart HA services and (if needed) CXFS services.

### Using `build_cmgr_script` for the Cluster Database

You can use the `build_cmgr_script` command from one node in the cluster to create a `cmgr` script that will recreate the node, cluster, switch, and filesystem definitions for all nodes in the cluster database. You can then later run the resulting script to recreate a database with the same contents; this method can be used for missing or corrupted cluster databases.

---

**Note:** The `build_cmgr_script` does not recreate node-specific information for resources and resource types or local logging information because the cluster database does not replicate node-specific information. Therefore, if you reinitialize the cluster database, you will lose node specific information. The `build_cmgr_script` script does not contain local logging information, so it cannot be used as a complete backup/restore tool.

---

To perform a database backup, use the `build_cmgr_script` script from one node in the cluster, as described in "Creating a cmgr Script Automatically" on page 135.

---



**Caution:** Do not make configuration changes while you are using the `build_cmgr_script` command.

---

By default, this creates a `cmgr` script in the following location:

```
/var/cluster/ha/tmp/cmgr_create_cluster_clusername_processID
```

You can specify another filename by using the `-o` option.

To perform a restore on all nodes in the pool, do the following:

1. Stop HA services for all nodes in the cluster.
2. Stop the cluster database daemons on each node.
3. Remove all copies of the old database by using the `cdbreinit` command on each node.
4. Execute the `cmgr` script (which was generated by the `build_cmgr_script` script) on the node that is defined first in the script. This will recreate the backed-up database on each node.

---

**Note:** If you want to run the generated script on a different node, you must modify the generated script so that the node is the first one listed in the script.

---

5. Restart cluster database daemons on each node.

For example, to backup the current database, clear the database, and restore the database to all nodes, do the following:

*On one node in the cluster:*

```
# /var/cluster/cmgr-scripts/build_cmgr_script -o /tmp/newcdb
Building cmgr script for cluster clusterA ...
build_cmgr_script: Generated cmgr script is /tmp/newcdb
```

*On one node:*

```
# stop ha_services for cluster clusterA
```

*On each node:*

```
# /etc/init.d/cluster stop
```

*On each node:*

```
# /usr/cluster/bin/cdbreinit
On each node:
# /etc/init.d/cluster start
```

*On the \*first\* node listed in the /tmp/newcdb script:*

```
# /tmp/newcdb
```

## Using cdbBackup and cdbRestore for the Cluster Database and Logging Information

The `cdbBackup` and `cdbRestore` commands backup and restore the cluster database and node-specific information, such as local logging information. You must run these commands individually for each node.

To perform a backup of the cluster, use the `cdbBackup` command on each node.



---

**Caution:** Do not make configuration changes while you are using the `cdbBackup` command.

---

To perform a restore, run the `cdbRestore` command on each node. You can use this method for either a missing or corrupted cluster database. Do the following:

1. Stop HA services.
2. Stop cluster services on each node.
3. Remove the old database by using the `cdbreinit` command on each node.

4. Stop cluster services again (these were restarted automatically by `cdbreinit` in the previous step) on each node.
5. Use the `cdbRestore` command on each node.
6. Start cluster services on each node.

For example, to backup the current database, clear the database, and then restore the database to all nodes, do the following:

*On each node:*

```
# /usr/cluster/bin/cdbBackup
```

*On one node in the cluster:*

```
# stop ha_services for cluster clusterA
```

*On each node:*

```
# /etc/init.d/cluster stop
```

*On each node:*

```
# /usr/cluster/bin/cdbreinit
```

*On each node (again):*

```
# /etc/init.d/cluster stop
```

*On each node:*

```
# /usr/cluster/bin/cdbRestore
```

*On each node:*

```
# /etc/init.d/cluster start
```

For more information, see the `cdbBackup` and `cdbRestore` man page.

---

**Note:** Do not perform a `cdbDump` while information is changing in the cluster database. Check the `SYSLOG` file for information to help determine when cluster database activity is occurring. As a rule of thumb, you should be able to perform a `cdbDump` if at least 15 minutes have passed since the last node joined the cluster or the last administration command was run.

---

## Filesystem Dump and Restore

To perform an XFS filesystem dump and restore, you must do the following:

1. Perform a backup of the cluster database using `cdbBackup`.
2. Perform the XFS filesystem dump with `xfsdump`.
3. Perform the XFS filesystem restore with `xfrestore`.
4. Remove the existing cluster database:  

```
# rm /var/cluster/cdb
```
5. Restore the backed-up database by using `cdbRestore`.

## Rotating Log Files

This section discusses the following:

- "Rotating All Log Files "
- "Rotating Large Log Files" on page 330

For information about log levels, see "Set Log Configuration" on page 246.

### Rotating All Log Files

You can run the `/var/cluster/cmgr-scripts/rotatelog` script to copy all files to a new location. This script saves log files with the day and the month name as a suffix. If you run the script twice in one day, it will append the current log file to the previous saved copy. The `root crontab` file has an entry to run this script weekly.

The script syntax is as follows:

```
/var/cluster/cmgr-scripts/rotatelog [-h] [-d|-u]
```

If no option is specified, the log files will be rotated. Options are as follows:

- h Prints the help message. The log files are not rotated and other options are ignored.
- d Deletes saved log files that are older than one week before rotating the current log files. You cannot specify this option and -u.
- u Unconditionally deletes all saved log files before rotating the current log files. You cannot specify this option and -d.

By default, the `rotatelogs` script will be run by `crontab` once a week, which is sufficient if you use the default log levels. If you plan to run with a high debug level for several weeks, you should reset the `crontab` entry so that the `rotatelogs` script is run more often.

On heavily loaded machines, or for very large log files, you may want to move resource groups and stop HA services before running `rotatelogs`.

## Rotating Large Log Files

You can use a script such as the following to copy large files to a new location. The files in the new location will be overwritten each time this script is run.

```
#!/bin/sh
# Argument is maximum size of a log file (in characters) - default: 500000

size=${1:-500000}
find /var/cluster/ha/log -type f ! -name '*.OLD' -size +${size}c -print | while read log_file; do
    cp ${log_file} ${log_file}.OLD
    echo '*** LOG FILE ROTATION ' `date` '***' > ${log_file}
done
```

## Granting Task Execution Privileges to Users

The GUI lets you grant or revoke access to a specific GUI task for one or more specific users. By default, only `root` may execute tasks in the GUI. You cannot grant or revoke tasks for users with a user ID of 0.

---

**Note:** To maintain security, the `root` user must have a password. If `root` does not have a password, then all users can get access to any task.

---

Access to the task is allowed only on the node to which the GUI is connected; if you want to allow access on another node in the pool, you must connect the GUI to that node and grant access again.

GUI tasks and the `cmgr` command operate by executing underlying privileged commands which are normally accessible only to `root`. When granting access to a task, you are in effect granting access to all of its required underlying commands, which results in also granting access to the other GUI tasks that use the same underlying commands.

To see which tasks a specific user can currently access, select **View: Users**. Select a specific user to see details about the tasks available to that user.

To see which users can currently access a specific task, select **View: Task Privileges**. Select a specific task to see details about the users who can access it and the privileged commands it requires.

## Grant Task Access to a User or Users

You can grant access to a specific task to one or more users at a time.

---

**Note:** Access to the task is only allowed on the node to which the GUI is connected; if you want to allow access on another node in the pool, you must connect the GUI to that node and grant access again.

---

Do the following:

1. Select the user or users for whom you want to grant access. You can use the following methods to select users:
  - Click to select one user at a time
  - `Shift+click` to select a block of users
  - `Ctrl+click` to toggle the selection of any one user, which allows you to select multiple users that are not contiguous
  - Click **Select All** to select all users

Click **Next** to move to the next page.

2. Select the task or tasks to grant access to, using the above selection methods. Click **Next** to move to the next page.

3. Confirm your choices by clicking **OK**.

---

**Note:** If more tasks than you selected are shown, then the selected tasks run the same underlying privileged commands as other tasks, such that access to the tasks you specified cannot be granted without also granting access to these additional tasks.

---

To see which tasks a specific user can access, select **View: Users**. Select a specific user to see details about the tasks available to that user.

To see which users can access a specific task, select **View: Task Privileges**. Select a specific task to see details about the users who can access it and the privileged commands it requires.

### Granting Access to a Few Tasks

Suppose you wanted to grant user `guest` permission to define clusterwide and node-specific resources. You would do the following:

1. Select `guest` and click **Next** to move to the next page.
2. Select the tasks you want `sys` to be able to execute:
  - a. Click **Define a Resource**
  - b. **Ctrl+click Redefine a Resource for a Specific Node**
  - c. **Ctrl+click Add or Remove Resources in Resource Group**

Click **Next** to move to the next page.

3. Confirm your choices by clicking **OK**.

Figure 8-1 shows the privileged commands that were granted to user `guest`.

---

**Note:** **Modify a Resource Definition** is also displayed, even though the administrator did not explicitly select it; the privilege commands for the tasks selected also require this command.

---



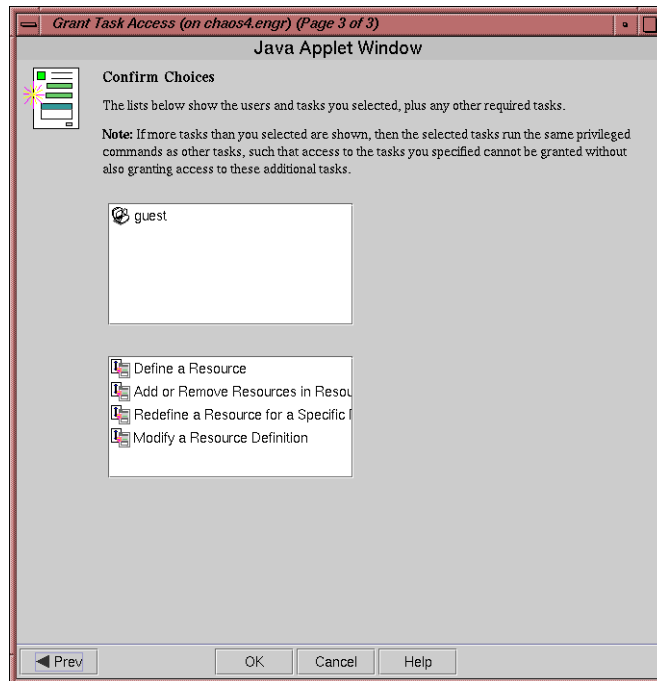

**Figure 8-1** Results of Granting a User Privilege

Figure 8-2 shows the screen that is displayed when you select **View: Users** and click **guest** to display information in the details area of the GUI window. The privileged commands listed are the underlying commands executed by the GUI tasks.

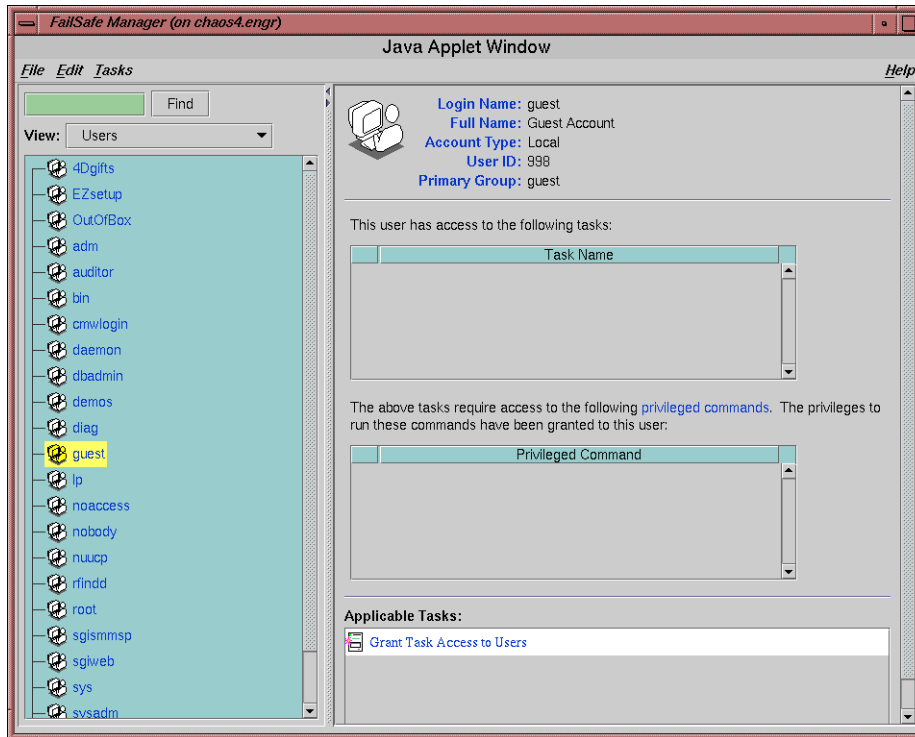

Figure 8-2 Displaying the Privileged Commands a User May Execute

### Granting Access to Most Tasks

Suppose you wanted to give user *sys* access to all tasks **except** adding or removing nodes from a cluster. The easiest way to do this is to select all of the tasks and then deselect the one you want to restrict. You would do the following:

1. Select *sys* and click **Next** to move to the next page.
2. Select the tasks you want *sys* to be able to execute:
  - a. Click **Select All** to highlight all tasks.
  - b. Deselect the task to which you want to restrict access. **Ctrl+click Add/Remove Nodes in Cluster.**

Click **Next** to move to the next page.

3. Confirm your choices by clicking **OK**.

## Revoke Task Access from a User or Users

You can revoke task access from one or more users at a time.

---

**Note:** Access to the task is only revoked on the node to which the GUI is connected; if a user has access to the task on multiple nodes in the pool, you must connect the GUI to those other nodes and revoke access again.

---

Do the following:

1. Select the user or users from whom you want to revoke task access. You can use the following methods to select users:
  - Click to select one user at a time
  - Shift+click to select a block of users
  - Ctrl+click to toggle the selection of any one user, which allows you to select multiple users that are not contiguous
  - Click **Select All** to select all users

Click **Next** to move to the next page.

2. Select the task or tasks to revoke access to, using the above selection methods. Click **Next** to move to the next page.
3. Confirm your choices by clicking **OK**.

---

**Note:** If more tasks than you selected are shown, then the selected tasks run the same underlying privileged commands as other tasks, such that access to the tasks you specified cannot be revoked without also revoking access to these additional tasks.

---

To see which tasks a specific user can access, select **View: Users**. Select a specific user to see details about the tasks available to that user.

To see which users can access a specific task, select **View: Task Privileges**. Select a specific task to see details about the users who can access it.

## Updating the Checksum Version for 6.5.21 and Earlier Clusters

The `ChecksumVersion` variable is required for clusters running IRIX 6.5.22 or later. Any cluster without this variable will use the old checksum behavior and the variable will not be present in the cluster database. All clusters created prior to IRIX 6.5.22 must set the variable manually.

If your cluster was created before IRIX 6.5.22, you must run the following command to add the `ChecksumVersion` variable to the cluster database and set it to the correct value. You must do this **after** all nodes in the cluster have been upgraded to IRIX 6.5.22 and are running normally.

For example, if the name of the cluster is `gps`, run the following `cbutil` command on one node in the cluster:

---

**Note:** Command arguments are case-sensitive.

---

```
# /usr/cluster/bin/cbutil -i
cbutil> node #cluster#gps#ClusterAdmin
cbutil> create ChecksumVersion
cbutil> setvalue ChecksumVersion 1
cbutil> quit
```

Cluster databases running IRIX 6.5.22 or later must have all nodes at 6.5.22 or later. Do not downgrade or add nodes to the cluster without setting `ChecksumVersion` to 0 (otherwise, the nodes will fail to form a membership). After you have upgraded all nodes to IRIX 6.5.22 or later set `ChecksumVersion` to 1 by running the following commands on one node in the cluster:

```
# /usr/cluster/bin/cbutil -i
cbutil> node #cluster#gps#ClusterAdmin
cbutil> setvalue ChecksumVersion 1
cbutil> quit
```

---

**Note:** The `create` step is missing here because the variable should already be in the cluster database at this point.

---

## Testing the Configuration

This chapter explains how to test the FailSafe system configuration using the FailSafe Manager GUI and the `cmgr` command. For general information on using these tools, see Chapter 5, "Administration Tools" on page 117.

The sections in this chapter are as follows:

- "Performing Diagnostic Tasks with the GUI"
- "Performing Diagnostic Tasks with `cmgr`" on page 338

### Performing Diagnostic Tasks with the GUI

This section describes how to perform diagnostic tasks with the GUI.

#### Test Connectivity with the GUI

This task requires `root rsh` access between nodes. To test connectivity, do the following from the **FailSafe Manager**:

---

**Note:** The **Test Node Connectivity** screen requires `rsh` access between hosts. The `/.rhosts` file must contain the hosts and local host between which you want to test connectivity.

---

- Choose whether to test by network or serial connectivity by clicking on the appropriate button.
- Choose a node to be tested from the pull-down list and add it to the test list by clicking on **Add**.  
To delete a node from the list of nodes to be tested, click on the logical name to select it and then click **Delete**.
- To start the tests, click on **Start Tests**. To stop the tests, click **Stop Tests**.
- To run another test, click **Clear Output** to clear the status screen.
- To exit from the window, click **Close**.

## Test Resources with the GUI

The **Test Resources** task lets you test the resources on the nodes in your cluster by entering the requested inputs. You can test resources by type and by group. You can test the resources of a resource type or in a resource group on all of the nodes in the cluster at one time, or you can specify an individual node to test. Resource tests are performed only on nodes in the resource group's application failover domain.

## Test Failover Policies with the GUI

The **Test Failover Policy** task lets you test whether a failover policy is defined correctly. This test checks the failover policy by validating the policy script and failover attributes, and whether the application failover domain consists of valid nodes from the cluster.

## Performing Diagnostic Tasks with `cmgr`

The following subsections described how to perform diagnostic tasks on your system using the `cmgr` command.

### Test the Serial Connections with `cmgr`

You can use the `cmgr` command to test the serial connections between the FailSafe nodes. This test performs a `ping` on each specified node through the serial line and produces an error message if the `ping` is not successful.

---

**Note:** Do not execute this command while FailSafe is running.

---

Use the following command to test the serial connections for the machines in a cluster:

```
test serial in cluster Clustername [on node node1 node node2 ...]
```

For example, to test multiple nodes:

```
cmgr> test serial in cluster test-cluster on node blue node green
```

The serial test yields an error message when it encounters its first error, indicating the node that did not respond. If you receive an error message after executing this test, verify the cable connections of the serial cable from the indicated node's serial port to

the remote power control unit or the system controller port of the other nodes and run the test again.

For example:

```
cmgr> test serial in cluster eagan on node cml
Success: testing serial...
Success: Ensuring Node Can Get IP Addresses For All Specified Hosts
Success: Number of IP addresses obtained for <cml> = 1
Success:      The first IP address for <cml> = 128.162.19.34
Success: Checking serial lines via crsd (crsd is running)
Success: Successfully checked serial line
Success: Serial Line OK
Success: overall exit status:success, tests failed:0, total tests executed:1
```

The following shows an example of an attempt to run the `test serial` command while FailSafe is running (causing the command to fail to execute):

```
cmgr> test serial in cluster eagan on node cml
Error: Cannot run the serial tests, diagnostics has detected FailSafe (ha_cmds) is running

Failed to execute FailSafe tests/diagnostics ha

test command failed
cmgr>
```

## Test Network Connectivity with `cmgr`

You can use the `cmgr` command to test the network connectivity in a cluster. This test checks if the specified nodes can communicate with each other through each configured interface in the nodes. This test will not run if FailSafe is running.

Use the following command to test the network connectivity for the machines in a cluster:

```
test connectivity in cluster Clustername [on node node1 node node2 ...]
```

The following shows an example of the `test connectivity` command:

```
cmgr> test connectivity in cluster eagan on node cml
Success: testing connectivity...
Success: checking that the control IP_addresses are on the same networks
Success: pinging address cml-priv interface ef0 from host cml
```

```
Success: pinging address cm1 interface ef1 from host cm1
Success: overall exit status:success, tests failed:0, total tests
executed:1
```

This test yields an error message when it encounters its first error, indicating the node that did not respond. If you receive an error message after executing this test, verify that the network interface has been configured up, using the `ifconfig` command, for example:

```
# /usr/etc/ifconfig ec3
ec3: flags=c63<UP,BROADCAST,NOTRAILERS,RUNNING,FILTMULTI,MULTICAST>
      inet 190.0.3.1 netmask 0xffffffff broadcast 190.0.3.255
```

The UP in the first line of output indicates that the interface is configured up.

If the network interface is configured up, verify that the network cables are connected properly and run the test again.

### Test Resources with `cmgr`

You can use the `cmgr` command to test any configured resource by resource name or by resource type.

Use the following to test a resource by name:

```
test resource Resourcename of resource_type RTname in cluster Clustername [on node Node1 node Node2 ...]
```

For example:

```
cmgr> test resource /disk1 of resource_type filesystem in cluster eagan on machine cm1
Success: *** testing node resources on node cm1 ***
Success: *** testing all filesystem resources on node cm1 ***
Success: testing resource /disk1 of resource type filesystem on node cm1
Success: overall exit status:success, tests failed:0, total tests executed:1
```



Use the following to test a resource by resource type:

```
test resource_type RTname in cluster Clustername [on node Node1 node Node2 ...]
```

For example:

```
cmgr> test resource_type filesystem in cluster eagan on machine cm1
Success: *** testing node resources on node cm1 ***
Success: *** testing all filesystem resources on node cm1 ***
Success: testing resource /disk4 of resource type filesystem on node cm1
Success: testing resource /disk5 of resource type filesystem on node cm1
Success: testing resource /disk2 of resource type filesystem on node cm1
Success: testing resource /disk3 of resource type filesystem on node cm1
Success: testing resource /disk1 of resource type filesystem on node cm1
Success: overall exit status:success, tests failed:0, total tests executed:5
```

You can use `cmgr` to test volume and filesystem resources in destructive mode. This provides a more thorough test of filesystems and volumes. `cmgr` tests will not run in destructive mode if FailSafe is running.

Use the following to test resources in destructive mode:

```
test resource Resourcename of resource_type RTname in cluster Clustername [on node Node1 node Node2 ...] destructive
```

The following sections describe the diagnostic tests available for resources.

### Test Logical Volumes with `cmgr`

You can use the `cmgr` command to test the logical volumes in a cluster. This test checks if the specified volume is configured correctly.

Use the following command to test a logical volume:

```
test resource Resourcename of resource_type volume on cluster Clustername [on node Node1 node Node2 ...]
```

For example:

```
cmgr> test resource alternate of resource_type volume on cluster eagan
Success: *** testing node resources on node cm1 ***
Success: *** testing all volume resources on node cm1 ***
Success: running resource type volume tests on node cm1
Success: *** testing node resources on node cm2 ***
Success: *** testing all volume resources on node cm2 ***
Success: running resource type volume tests on node cm2
Success: overall exit status:success, tests failed:0, total tests executed:2
```

The following example tests a logical volume in destructive mode:

```
cmgr> test resource alternate of resource_type volume on cluster eagan destructive
Warning: executing the tests in destructive mode
Success: *** testing node resources on node cm1 ***
Success: *** testing all volume resources on node cm1 ***
Success: running resource type volume tests on node cm1
Success: successfully assembled volume: alternate
Success: *** testing node resources on node cm2 ***
Success: *** testing all volume resources on node cm2 ***
Success: running resource type volume tests on node cm2
Success: successfully assembled volume: alternate
Success: overall exit status:success, tests failed:0, total tests executed:2
```

### Test Filesystems with cmgr

You can use cmgr to test the filesystems configured in a cluster. This test checks if the specified filesystem is configured correctly and if the volume the filesystem will reside on is configured correctly.

Use the following command to test a filesystem:

```
test resource Resourcename of resource_type filesystems on cluster Clustername [on node Node1 node Node2 ...]
```

The following example displays the filesystems that have been defined in a cluster and tests one of them:

```
cmgr> show resources of resource_type filesystem in cluster eagan
/disk4 type filesystem
/disk5 type filesystem
/disk2 type filesystem
/disk3 type filesystem
/disk1 type filesystem
cmgr> test resource /disk4 of resource_type filesystem in cluster eagan on node cm1
Success: *** testing node resources on node cm1 ***
Success: *** testing all filesystem resources on node cm1 ***
Success: successfully mounted filesystem: /disk4
Success: overall exit status:success, tests failed:0, total tests executed:1
```

The following example tests a filesystem in destructive mode:

```
cmgr> test resource /disk4 of resource_type filesystem in cluster eagan on node cml destructive
Warning: executing the tests in destructive mode
Success: *** testing node resources on node cml ***
Success: *** testing all filesystem resources on node cml ***
Success: successfully mounted filesystem: /disk4
Success: overall exit status:success, tests failed:0, total tests executed:1
```

### Test Resource Groups with cmgr

You can use cmgr to test a resource group. This test cycles through the resource tests for all of the resources defined for a resource group. Resource tests are performed only on nodes in the resource group's application failover domain.

Use the following to test resource groups:

```
test resource_group RGname in cluster Clustername [on node Node1 node Node2 ...]
```

The following displays the resource groups that have been defined in a cluster and test one of them:

```
cmgr> show resource_groups in cluster eagan
Resource Groups:
    nfs2
    informix
cmgr> test resource_group nfs2 in cluster eagan on machine cml
Success: *** testing node resources on node cml ***
Success: testing resource /disk4 of resource type NFS on node cml
Success: testing resource /disk3 of resource type NFS on node cml
Success: testing resource /disk3/statmon of resource type statd_unlimited on node cml
Success: testing resource 128.162.19.45 of resource type IP_address on node cml
Success: testing resource /disk4 of resource type filesystem on node cml
Success: testing resource /disk3 of resource type filesystem on node cml
Success: testing resource dmfl of resource type volume on node cml
Success: testing resource dmfjournals of resource type volume on node cml
Success: overall exit status:success, tests failed:0, total tests executed:16
```

## Test Failover Policies with `cmgr`

You can use `cmgr` to test whether a failover policy is defined correctly. This test checks the failover policy by validating the policy script, failover attributes, and whether the application failover domain consists of valid nodes from the cluster.

Use the following to test a failover policy:

```
test failover_policy FPname in cluster Clustername [on node Node1 node Node2 ...]
```

The following example uses a `show` command to display the failover policies that have been defined in a cluster and tests one of them:

```
cmgr> show failover_policies
Failover Policies:
    reverse
    ordered-in-order
cmgr> test failover_policy reverse in cluster eagan
Success: *** testing node resources on node cm1 ***
Success: testing policy reverse on node cm1
Success: *** testing node resources on node cm2 ***
Success: testing policy reverse on node cm2
Success: overall exit status:success, tests failed:0, total tests executed:2
```

## System Recovery and Troubleshooting

This chapter provides information on FailSafe system recovery, and includes sections on the following topics:

- "Overview of System Recovery"
- "Disabling Resource Groups for Maintenance" on page 350
- "FailSafe Log Files" on page 351
- "FailSafe Membership and Resets" on page 352
- "Status Monitoring" on page 354
- "XVM Alternate Path Failover" on page 355
- "Dynamic Control of FailSafe HA Services" on page 356
- "Recovery Procedures" on page 357
- "CXFS Metadata Server Relocation" on page 369
- "Other Problems with CXFS Coexecution" on page 369

### Overview of System Recovery

When a FailSafe system experiences problems, you can use some of the FailSafe features and commands to determine where the problem is located.

FailSafe provides the following tools to evaluate and recover from system failure:

- Log files
- Commands to monitor status of system components
- Commands to start, stop, and fail over highly available services

Keep in mind that the FailSafe logs may not detect system problems that do not translate into FailSafe problems. For example, if a CPU goes bad, or hardware maintenance is required, FailSafe may not be able to detect and log these failures.

In general, when evaluating system problems of any nature on a FailSafe configuration, you should determine whether you need to shut down a node to address those problems.

When you shut down a node, perform the following steps:

1. Stop FailSafe HA services on that node
2. Shut down the node to perform needed maintenance and repair
3. Start up the node
4. Start FailSafe HA services on that node

It is important that you explicitly stop FailSafe HA services before shutting down a node, where possible, so that FailSafe does not interpret the node shutdown as node failure. If FailSafe interprets the service interruption as node failure, there could be unexpected ramifications, depending on how you have configured your resource groups and your application failover domain.

When you shut down a node to perform maintenance, you may need to change your FailSafe configuration to keep your system running.

## Identifying the Cluster Status

When you encounter a problem, identify the cluster status by answering the following questions:

- Are the cluster processes (`cmond`, `crsd`, `fs2d`, and `cad`) and HA processes (`ha_cmsd`, `ha_gcd`, `ha_srmd`, `ha_fsd`, and `ha_ifd`) are running?
- Are the cluster, node, and resource group states consistent on each node? Run the `cluster_status` command on each node and compare, or run the GUI connecting to each node in the cluster.
- Which nodes are in the FailSafe membership? Check the status with the `cluster_status` and `cmgr` commands, and see the `/var/adm/SYSLOG` file.
- Which nodes are in the cluster database (`fs2d`) membership? See the `/var/cluster/ha/log/fs2d_log` files on each node.
- Is the database consistent on all nodes? Determine this logging in to each node and examining the `/var/cluster/ha/log/fs2d_log` file and database checksum.

## Locating Problems

To locate the problem, do the following:

- Examine the following log files:

```
/var/cluster/ha/log/cad_log  
/var/cluster/ha/log/cli_Hostname  
/var/cluster/ha/log/crsd_Hostname  
/var/cluster/ha/log/fs2d_Hostname
```

- Search for errors in all log files. Examine all messages within the timeframe in question.
- Trace errors to the source. Try to find an event that triggered the error.
- Gather process accounting data.
- Use the `icrash` commands.
- Use detailed information from the view area in the GUI to drill down to specific configuration information.
- Run the **Test Connectivity** task in the GUI.
- Get a dump of the cluster database. You can extract such a dump with the following command:  

```
# /usr/cluster/bin/cdbutil -c 'gettree #' > dumpfile
```
- Determine which nodes are in the FailSafe membership with the `cluster_status` command.

## Common Problems

The following are common problems and solutions:

- "Timed-out Resource Monitor Script" on page 348
- "GUI Will Not Run" on page 348
- "Log Files Consume Too Much Disk Space" on page 349
- "Unable to Define a Node" on page 349

- "System is Hung" on page 349
- "You Cannot Log In" on page 349
- "Power Failure" on page 350
- "Error Messages During Remote Installation" on page 350

### Timed-out Resource Monitor Script

You may be able to diagnose why a `monitor` action script has timed out by examining the process accounting data. This assumes that you have previously enabled either extended accounting or Comprehensive System Accounting on all production servers, as recommended in "Enabling System Accounting" on page 78.

Do the following:

- Determine the timeframe of the problem as a start-time and end-time. You may need to convert this time to GMT depending on how you have your system configured.
- Determine the process ID (PID) of the monitor task that timed out. This can be done by looking at the `srmd` log or by finding the monitor task with a long elapsed time from accounting data.
- Select the accounting records of interest and create a PID tree from the output.

### GUI Will Not Run

If the GUI will not run, check the following:

- Is the license properly installed?
- Are the cluster daemons running?
- Are the `tcpmux` and `tcpmux/sgi_sysadm` services enabled in the `/etc/inetd.conf` file?
- Are the `inetd` or `tcp` wrappers interfering? This may be indicated by `connection refused` or `login failed` messages.



## Log Files Consume Too Much Disk Space

If the log files are consuming too much disk space, you should rotate them according to the directions in the *FailSafe Administrator's Guide for SGI InfiniteStorage*. You may also want to consider choosing a less-verbose log level.

## Unable to Define a Node

If you are unable to define a node, it may be that there are hostname resolution problems. See the information about hostname resolution rules in the *FailSafe Administrator's Guide for SGI InfiniteStorage*.

## System is Hung

The following may cause the system to hang:

- Overrun disk drives.
- Heartbeat was lost. In this case, you will see a message that mentions `withdrawal of node`.
- As a last resort, do a nonmaskable interrupt (NMI) of the system and contact SGI. (The NMI tells the kernel to panic the node so that an image of memory is saved and can be analyzed later.) For more information, see the owner's guide for the node.

Make `vmcore.#.comp`, `unix.#`, `/var/adm/SYSLOG`, and cluster log files available.

## You Cannot Log In

If you cannot log in to a FailSafe node, you can use one of the following commands, assuming the node you are on is listed in the other nodes' `.rhosts` files:

```
# rsh hostname ksh -i
# rsh hostname csh -i
```

## Power Failure

In the case of a power failure, the first node to join the cluster will wait for the number of seconds specified by the `_CMS_WAIT_FOR_ALL_TIMEOUT` parameter before attempting to start resource groups. This delay allows the other nodes time to join the cluster.

To modify this value, use the `modify ha_parameters` command to `cmgr` command to set a value for `node_wait` or the **Set FailSafe HA Parameters** GUI task. For more information, see "Set FailSafe HA Parameters" on page 244.

If the value is not set for the cluster, FailSafe calculates this value by multiplying the `node-timeout` value by the number of nodes.

## Error Messages During Remote Installation

If you are performing a remote installation, you may see messages such as the following:

```
cdb-exitop: can't run remotely - scheduling to run later
```

When you perform a remote or miniroot install, the `exitop` commands are deferred until cluster services are started, at which time the `exitop` commands will be run. For more information, see "Differences When Performing a Remote or Miniroot Install" on page 91.

## Disabling Resource Groups for Maintenance

If you must disable resources, such as when you want to perform maintenance on a node, use the following procedure:

1. Offline the resource groups by using the `offline_detach` option or `offline_detach_force` option (if the resource group is in error). For more information, see "Resource Group Recovery" on page 359 , and "Resource Group Maintenance and Error Recovery" on page 360.
2. Perform the needed maintenance.
3. Reboot the node.
4. Online the resource group.

## Ensuring that Resource Groups are Deallocated

Performing an `admin offline_force` does not guarantee that all resource groups are offline. If you run into errors, such as with an `admin move` command, you should verify that the resource groups have been deallocated.

### Checking for Exclusivity

After performing an `admin offline_force`, you should run the `exclusive` script with the appropriate arguments to verify that the resource in question is not running, or perform a check similar to that done by the script.

### Stopping Resources Manually

You must stop resources according to their execution order, from highest to lowest. Use the `exclusive` scripts to verify whether or not a resource needs to be stopped.

## FailSafe Log Files

FailSafe maintains system logs for each of the FailSafe daemons. You can customize the system logs according to the level of logging you wish to maintain. Table 10-1 shows the levels of messages.

For information on setting logging for `cad`, `cmond`, and `fs2d`, see "Configure System Files" on page 92. For information on setting up log configurations, see "Set Log Configuration" on page 246 in Chapter 6, "Configuration" on page 141.

**Table 10-1** Message Levels

---

Message Level	Description
Normal	Normal messages report on the successful completion of a task. An example of a normal message is as follows (<N notation indicates a normal message):  Wed Sep 2 11:57:25.284 <N ha_gcd cms 10185:0> Delivering TOTAL membership (S# 1, GS# 1)

---

Message Level	Description
Error/Warning	<p>Error or warning messages indicate that an error has occurred or may occur soon. These messages may result from using the wrong command or improper syntax. An example of a warning message is as follows (&lt;W notation indicates a warning. &lt;E indicates an error.):</p> <pre>Wed Sep 2 13:45:47.199 &lt;W crsd crs 9908:0 crs_config.c:634&gt; CI_ERR_NOTFOUND, safer - no such node</pre>
SYSLOG	<p>All normal and error messages are also logged to syslog. SYSLOG messages include the symbol &lt;CI&gt; in the header to indicate they are cluster-related messages. An example of a SYSLOG message is as follows:</p> <pre>Wed Sep 2 12:22:57 6X:safe syslog: &lt;&lt;CI&gt; ha_cmds misc 10435:0&gt; CI_FAILURE, I am not part of the enabled cluster anymore</pre>
Debug	<p>Debug messages appear in the log group file when the logging level is set to debug0 or higher (using the GUI) or 10 or higher (using cmgr). The following message is logged at debug0 (see D0 in the message) or log level 10:</p> <pre>Thu Sep 27 14:43:24.233 &lt;D0 ha_fsd fsd 57540:0 fs_failsafe.c:1471&gt; Determine oldest state: coordinator: perf22/0x10001</pre>

---

Examining the log files should enable you to see the nature of the system error. Noting the time of the error and looking at the log files to observe the activity of the various daemons immediately before error occurred, you may be able to determine what situation existed that caused the failure.

---

**Note:** Many megabytes of disk space can be consumed on the server when debug levels are used in a log configuration.

---

See Appendix C, "System Messages" on page 403.

## FailSafe Membership and Resets

In looking over the actions of a FailSafe system on failure to determine what has gone wrong and how processes have transferred, it is important to consider the concept of FailSafe membership. When failover occurs, the runtime failover domain can include only those nodes that are in the FailSafe membership.

## FailSafe Membership and Tie-Breaker Node

Nodes can enter into the FailSafe membership only when they are not disabled and they are in a known state. This ensures that data integrity is maintained because only nodes within the FailSafe membership can access the shared storage. If nodes that are outside the membership and are not controlled by FailSafe were able to access the shared storage, two nodes might try to access the same data at the same time; this situation would result in data corruption. For this reason, disabled nodes do not participate in the membership computation.

---

**Note:** No attempt is made to reset nodes that are configured disabled before confirming the FailSafe membership.

---

FailSafe membership in a cluster is based on a quorum majority. For a cluster to be enabled, more than 50% of the nodes in the cluster must be in a known state, able to talk to each other, using heartbeat control networks. This quorum determines which nodes are part of the FailSafe membership that is formed.

If there are an even number of nodes in the cluster, it is possible that there will be no majority quorum; there could be two sets of nodes, each consisting of 50% of the total number of node, unable to communicate with the other set of nodes. In this case, FailSafe uses the node that has been configured as the tiebreaker node when you configured your FailSafe parameters. If no tiebreaker node was configured, FailSafe uses the node with the lowest ID number where HA services have been started.

The nodes in a quorum attempt to reset the nodes that are not in the quorum. Nodes that can be reset are declared `DOWN` in the membership, nodes that could not be reset are declared `UNKNOWN`. Nodes in the quorum are `UP`.

If a new majority quorum is computed, a new membership is declared whether any node could be reset or not.

If at least one node in the current quorum has a current membership, the nodes will proceed to declare a new membership if they can reset at least one node.

If all nodes in the new tied quorum are coming up for the first time, they will try to reset and proceed with a new membership only if the quorum includes the tiebreaker node.

If a tied subset of nodes in the cluster had no previous membership, then the subset of nodes in the cluster with the tiebreaker node attempts to reset nodes in the other subset of nodes in the cluster. If at least one node reset succeeds, a new membership is confirmed.

If a tied subset of nodes in the cluster had previous membership, the nodes in one subset of nodes in the cluster attempt to reset nodes in the other subset of nodes in the cluster. If at least one node reset succeeds, a new membership is confirmed. The subset of nodes in the cluster with the tiebreaker node resets immediately; the other subset of nodes in the cluster attempts to reset after some time.

Resets are done through system controllers connected to tty ports through serial lines. Periodic serial line monitoring never stops. If the estimated serial line monitoring failure interval and the estimated heartbeat loss interval overlap, the cause is likely a power failure at the node being reset.

## No Membership Formed

When no FailSafe membership is formed, you should check the following areas for possible problems:

- Is the `ha_cmds` FailSafe membership daemon running? Is the `fs2d` database daemon running?
- Can the nodes communicate with each other? Are the control networks configured as heartbeat networks?
- Can the control network addresses be reached by a `ping` command issued from peer nodes?
- Are the quorum majority or tie rules satisfied? Look at the `cmds` log to determine membership status.
- If a reset is required, are the following conditions met?
  - Is the `crsd` node control daemon up and running?
  - Is the reset serial line in good health?

You can look at the `crsd` log for the node you are concerned with, or execute an `admin ping` and `admin reset` command on the node to check this.

## Status Monitoring

FailSafe allows you to monitor and check the status of specified clusters, nodes, resources, and resource groups. You can use this feature to isolate the location of system problems.

You can monitor the status of the FailSafe components continuously through their visual representation in the GUI view area. Using the `cmgr` command, you can display the status of the individual components by using the `show` command.

For information on status monitoring and on the meaning of the states of the FailSafe components, see "System Status" on page 297 of Chapter 8, "FailSafe System Operation".

## XVM Alternate Path Failover

Messages in the `/var/adm/SYSLOG` file indicate that XVM has detected a failure in the disk path and has successfully used alternate path failover for `lun0`; that is, the cluster is in a degraded state and requires attention from the system administrator. For example (line breaks added for readability):

```
Jun 26 13:21:55 5A:gold2 unix: NOTICE: xvm_serverpal_iodone: done with retry ior 0xa800000041afe100
for physvol 0xa8000000008eae00
Jun 26 13:21:55 6A:gold2 unix: dksc 50050cc002004b23/lun0vol/c4p3: <6>SCSI driver error: device
does not respond to selection
Jun 26 13:21:55 6A:gold2 unix: dksc 50050cc002004b23/lun0vol/c4p3: <6>SCSI driver error: device
does not respond to selection
Jun 26 13:21:55 4A:gold2 unix: WARNING: XVM: WRITE I/O error - errno 5, dev 0x134, bp 0xa800000059bcd80,
b_flags 0x100400c, b_addr 0x0, b_pages 0xa800000202127600, io_resid -4611686018427387904, io_error
0xa800000000000000
Jun 26 13:21:55 6A:gold2 unix: dksc 50050cc002004b23/lun0vol/c4p3: <6>SCSI driver error: device does
not respond to selection
Jun 26 13:21:55 4A:gold2 unix: WARNING: XVM: WRITE I/O error - errno 5, dev 0x134, bp 0xa80000024bef9980,
b_flags 0x100400c, b_addr 0x0, b_pages 0xa8000000025aa040, io_resid -4611686018427387904, io_error
0xa800000200000000
Jun 26 13:21:55 4A:gold2 unix: WARNING: XVM: WRITE I/O error - errno 5, dev 0x134, bp 0xa800000011037600,
b_flags 0x100400c, b_addr 0x0, b_pages 0xa8000000024fc3c0, io_resid -6341068275337592832, io_error
0xa800000000000000
Jun 26 13:21:55 4A:gold2 unix: WARNING: XVM: WRITE I/O error - errno 5, dev 0x134, bp 0xa800000259171680,
b_flags 0x100400c, b_addr 0x0, b_pages 0xa8000000024e5a80, io_resid 0, io_error 0x0
Jun 26 13:21:55 4A:gold2 unix: WARNING: XVM: failover successful. Failover from dev 0x134 to dev 0x156
(/hw/module/001c01/Ibrick/xtalk/14/pci/1/scsi_ctlr/0/node/50050cc002004b23/port/2/lun/0/disk/volume/block)
physvol 0x1b7
Jun 26 13:21:55 5A:gold2 unix: NOTICE: xvm_serverpal_iodone: done with retry ior 0xa800000041afe100 for
physvol 0xa8000000008eae00
```

These messages in the SYSLOG file would be produced by the following /etc/failover.conf file:

```
#ident $Revision: 1.31 $
#
#   This is the configuration file for table configured failover support.
#
#   Please see the failover (7m) manual page for details on failover and
#   on how to use this file.
#
#disable_target_lun_check
lun2    50050cc002004b23/lun2/c4p3 \
        50050cc002004b23/lun2/c3p2 \
        50050cc002004b23/lun2/c3p3 \
        50050cc002004b23/lun2/c4p2
lun1    50050cc002004b23/lun1/c4p3 \
        50050cc002004b23/lun1/c3p2 \
        50050cc002004b23/lun1/c3p3 \
        50050cc002004b23/lun1/c4p2
lun0    50050cc002004b23/lun0/c4p3 \
        50050cc002004b23/lun0/c3p2 \
        50050cc002004b23/lun0/c3p3 \
        50050cc002004b23/lun0/c4p2
```

## Dynamic Control of FailSafe HA Services

FailSafe allows you to perform a variety of administrative tasks that can help you troubleshoot a system with problems without bringing down the entire system. These tasks include the following:

- You can add or delete nodes from a cluster without affecting the FailSafe HA services and the applications running in the cluster.
- You can add or delete a resource group without affecting other online resource groups.
- You can add or delete resources from a resource group while it is still online.
- You can change FailSafe parameters such as the heartbeat interval and the node timeout and have those values take immediate affect while the services are up and running.



- You can start and stop FailSafe HA services on specified nodes.
- You can move a resource group online, or take it offline.
- You can stop the monitoring of a resource group by putting the resource group into maintenance mode. This is not an expensive operation, as it does not stop and start the resource group, it just puts the resource group in a state where it is not available to FailSafe.
- You can reset individual nodes.

For information on how to perform these tasks, see Chapter 6, "Configuration" on page 141, and Chapter 8, "FailSafe System Operation".

## Recovery Procedures

The following sections describe various recovery procedures you can perform when different failsafe components fail. Procedures for the following situations are provided:

- "Single-Node Recovery" on page 358
- "Cluster Error Recovery" on page 358
- "Resource Group Recovery" on page 359
- "Node Error Recovery" on page 359
- "Resource Group Maintenance and Error Recovery" on page 360
- "Clear Resource Error State" on page 363
- "Control Network Failure Recovery" on page 364
- "Serial Cable Failure Recovery" on page 364
- "Cluster Database Sync Failure" on page 365
- "Cluster Database Maintenance and Recovery" on page 365
- "GUI Will Not Run" on page 366
- "GUI and cmgr Inconsistencies" on page 367
- "GUI Does Not Report Information" on page 367

- "Using the `cdbreinit` Command" on page 368
- "Action Script Configuration Errors" on page 368

## Single-Node Recovery

When one of the nodes in a two-node cluster is intended to stay down for maintenance or cannot be brought up, a set of procedures must be followed so that the database on the surviving node knows that that node is down and therefore should not to be considered in the failover domain. Without these procedures, the resources cannot come online because half or more of the failover domain is down.

See the procedure in "Two-Node Clusters: Single-Node Use" on page 292.

## Cluster Error Recovery

Use the following procedure if status of the cluster is UNKNOWN in all nodes in the cluster:

1. Check to see if there are control networks that have failed (see "Control Network Failure Recovery" on page 364).
2. Determine if there are sufficient nodes in the cluster that can communicate with each other using control networks in order to form a quorum. (At least 50% of the nodes in the cluster must be able to communicate with each other.) If there is an insufficient number of nodes, stop HA services on the nodes that cannot communicate (using the `force` option); this will change the number of nodes used in the quorum calculation.
3. If there are no hardware configuration problems, do the following:
  - Detach all resource groups that are online in the cluster (if any)
  - Stop HA services in the cluster
  - Restart HA services in the cluster

See "Resource Group Recovery" on page 359

For example, the following `cmgr` command detaches the resource group `web-rg` in cluster `web-cluster`:

```
cmgr> admin detach resource_group web-rg in cluster web-cluster
```

To stop HA services in the cluster `web-cluster` and ignore errors (`force` option), use the following command:

```
cmgr> stop ha_services for cluster web-cluster force
```

To start HA services in the cluster `web-cluster`, use the following command:

```
cmgr> start ha_services for cluster web-cluster
```

## Resource Group Recovery

The fact that a resource group is in an error state does not mean that all resources in the resource group have failed. However, to get the resources back into an `online` state, you must first set them to the `offline` state. You can do without actually taking the resources offline by using the following `cmgr` command:

```
admin offline_detach_force RGname [in cluster Clustername]
```

For example:

```
cmgr> admin offline_detach_force RG1 in cluster test-cluster
```



**Caution:** You should use the `InPlace_Recovery` failover policy attribute when using this command. This attribute specifies that the resources will stay on the same node where they were running at the time when the `offline_detach_force` command was run.

---

## Node Error Recovery

When a node is not able to talk to the majority of nodes in the cluster, the `SYSLOG` will display a message that the `CMSD` is in a lonely state. Another problem you may see is that a node is getting reset or going to an unknown state.

Use the following procedure to resolve node errors:

1. Verify that the control networks in the node are working (see "Control Network Failure Recovery" on page 364).
2. Verify that the serial reset cables to reset the node are working (see "Serial Cable Failure Recovery" on page 364).
3. Verify that the `sgi-cmsd` port is the same in all nodes in the cluster.

4. Check the node configuration; it should be consistent and correct.
5. Check `SYSLOG` and `cmsd` logs for errors. If a node is not joining the cluster, check the logs of the nodes that are part of the cluster.
6. If there are no hardware configuration problems, stop HA services in the node and restart HA services.

For example, to stop HA services in the node `web-node3` in the cluster `web-cluster`, ignoring errors (`force` option), use the following command:

```
cmgr> stop ha_services in node web-node3 for cluster web-cluster force
```

For example, to start HA services in the node `web-node3` in the cluster `web-cluster`, use the following command:

```
cmgr> start ha_services in node web-node3 for cluster web-cluster
```

## Resource Group Maintenance and Error Recovery

To do simple maintenance on an application that is part of the resource group, use the following procedure. This procedure stops monitoring the resources in the resource group when maintenance mode is on. You must turn maintenance mode off when performing application maintenance.



---

**Caution:** If there is a node failure on the node where resource group maintenance is being performed, the resource group is moved to another node in the failover policy domain.

---

For example:

1. To put a resource group `web-rg` in maintenance mode, use the following `cmgr` command:

```
cmgr> admin maintenance_on resource_group web-rg in cluster web-cluster
```

2. The resource group state changes to `ONLINE_MAINTENANCE`. Do whatever application maintenance is required. (Rotating application logs is an example of simple application maintenance).

3. To remove a resource group `web-rg` from maintenance mode, use the following command:

```
cmgr> admin maintenance_off resource_group web-rg in cluster web-cluster
```

The resource group state changes back to ONLINE.

Perform the following procedure when a resource group is in an ONLINE state and has an SRMD EXECUTABLE ERROR:

1. Look at the SRM logs (default location: `/var/cluster/ha/logs/srmd_Nodename`) to determine the cause of failure and the resource that has failed. Search for the ERROR string in the SRMD log file:

```
Wed Nov 3 04:20:10.135
<E ha_srmd srm 12127:1 sa_process_tasks.c:627>
CI_FAILURE, ERROR: Action (start) for resource (192.0.2.45) of type
(IP_address) failed with status (failed)
```

2. Check the script logs on that same node for `IP_address` start script errors.
3. Fix the cause of failure. This might require changes to resource configuration or changes to resource type stop/start/failover action timeouts.
4. After fixing the problem, move the resource group offline with the `force` option and then move the resource group online in the cluster.

For example, the following command moves the resource group `web-rg` in the cluster `web-cluster` offline and ignores any errors:

```
cmgr> admin offline resource_group web-rg in cluster web-cluster force
```

The following command moves the resource group `web-rg` in the cluster `web-cluster` online:

```
cmgr> admin online resource_group web-rg in cluster web-cluster
```

The resource group `web-rg` should be in an ONLINE state with no error.

Use the following procedure when a resource group is not online but is in an error state. Most of these errors occur as a result of the exclusivity process. This process, run when a resource group is brought online, determines if any resources are already allocated somewhere in the failure domain of a resource group. Note that exclusivity scripts return that a resource is allocated on a node if the script fails in any way. In other words, unless the script can determine that a resource is not present, it returns a value indicating that the resource is allocated.

Some possible error states include: `SPLIT RESOURCE GROUP (EXCLUSIVITY)`, `NODE NOT AVAILABLE (EXCLUSIVITY)`, `NO AVAILABLE NODES` in failure domain. See "Resource Group Status" on page 303, for explanations of resource group error codes.

1. Look at the `failsafe` and `SRMD` logs (default directory: `/var/cluster/ha/logs`, files: `failsafe_Nodename`, `srmd_Nodename`) to determine the cause of the failure and the resource that failed.

For example, suppose that the task of moving a resource group online results in a resource group with error state `SPLIT RESOURCE GROUP (EXCLUSIVITY)`. This means that parts of a resource group are allocated on at least two different nodes. One of the `failsafe` logs will have the description of which nodes are believed to have the resource group partially allocated:

```
[Resource Group:RGname]:Exclusivity failed -- RUNNING on Node1 and Node2
```

```
[Resource Group:RGname]:Exclusivity failed -- PARTIALLY RUNNING on Node1 and PARTIALLY RUNNING on Node2
```

At this point, look at the `srmd` logs on each of these nodes for exclusive script errors to see what resources are believed to be allocated. In some cases, a misconfigured resource will show up as a resource that is allocated. This is especially true for `Netscape_web` resources.

2. Fix the cause of the failure. This might require changes to resource configuration or changes to resource type start/stop/exclusivity timeouts.
3. After fixing the problem, move the resource group offline with the `force` option and then move the resource group online.

Perform the following checks when a resource group shows a `no more nodes in AFD` error:

1. All nodes in the failover domain are not in the membership. Check `CMSD` logs for errors.
2. Check the `SRMC/script` logs on all nodes in the failover domain for start/monitor script errors.

There are a few double failures that can occur in the cluster that will cause resource groups to remain in a non-highly-available state. At times a resource group might be stuck in an offline state. A resource group might also stay in an error state on a node even when a new node joins the cluster and the resource group can migrate to that node to clear the error. When these circumstances arise, do the following:

1. If the resource group is offline, try to move it online.
2. If the resource group is stuck on a node, detach the resource group and then bring it back online again. This should clear many errors.
3. If detaching the resource group does not work, force the resource group offline, then bring it back online.
4. If commands appear to be hanging or not working properly, detach all resource groups, then shut down the cluster and bring all resource groups back online.

See "Take a Resource Group Offline" on page 317, for information on detaching resource groups and forcing resource groups offline.

## Clear Resource Error State

Use this procedure when a resource that is not part of a resource group is in an ONLINE state with an error. This can happen when the addition or removal of resources from a resource group fails.

Do the following:

1. Look at the SRM logs to determine the cause of failure and the resource that has failed. The default location is:

```
/var/cluster/ha/logs/srmd_Nodename
```

2. Fix the problem that caused the failure. This might require changes to resource configuration or changes to resource type stop/start/failover action timeouts.
3. Clear the error state with the GUI or the `cmgr` command:
  - Use the **Clear Resource Error State** GUI task. Provide the following information:
    - **Resource Type:** select the type of the resource

- **Resource in Error State:** select the name of the resource that should be cleared from the error state

Click **OK** to complete the task.

- Use the `cmgr admin offline_force` command to move the resource offline. For example, to remove the error state of resource `web-srvr` of type `Netscape_Web`, making it available to be added to a resource group, enter the following:

```
cmgr> admin offline_force resource web-srvr of resource_type Netscape_Web in cluster web-cluster
```

## Control Network Failure Recovery

Control network failures are reported in `cmsd` logs. The default location of `cmsd` log is `/var/cluster/ha/logs/cmsd_Nodename`. Follow this procedure when the control network fails:

1. Use the `ping` command to check whether the control network IP address is configured in the node.
2. Check node configuration to see whether the control network IP addresses are correctly specified.

The following `cluster_mgr` command displays node configuration for `web-node3`:

```
cmgr> show node web-node3
```

3. If IP names are specified for control networks instead of IP addresses in `XX.XX.XX.XX` notation, check to see whether IP names can be resolved using DNS. You should use IP addresses instead of IP names.
4. Check whether the heartbeat interval and node timeouts are correctly set for the cluster. These HA parameters can be seen using `cluster_mgr show ha_parameters` command.

## Serial Cable Failure Recovery

Serial cables are used for resetting a node when there is a node failure. Serial cable failures are reported in `crsd` logs. The default location for the `crsd` log is `/var/cluster/ha/log/crsd_Nodename`.



Check the node configuration to see whether serial cable connection is correctly configured.

The following `cmgr` command displays node configuration for `web-node3`

```
cmgr> show node web-node3
```

Use the `admin ping` command to verify the serial cables. The following command reports serial cables problems in node `web-node3`:

```
cmgr> admin ping node web-node3
```

## Cluster Database Sync Failure

If the cluster database synchronization fails, use the following procedure:

1. Check for the following message in the `SYSLOG` file on the target node:

```
Starting to receive CDB sync series from machine <node1_node_ID>
...
Finished receiving CDB sync series from machine <node1_node_ID>
```

2. Check for control network or `portmapper/rpcbind` problems.
3. Check the node definition in the cluster database.
4. Check the `SYSLOG` and `fs2d` logs on the source node.

## Cluster Database Maintenance and Recovery

When the entire cluster database must be reinitialized, stop HA services on all nodes in the cluster, and then execute the following command on all nodes in the cluster:

```
# /usr/cluster/bin/cdbreinit /var/cluster/cdb/cdb.db
```

This command stops cluster processes, reinitializes the database and restarts all cluster processes. The contents of the cluster database will be automatically synchronized with other nodes if other nodes in the pool are available.

Otherwise, the cluster database must be restored from backup at this point. For instructions on backing up and restoring the cluster database, see "Cluster Database Backup and Restore" on page 325.

## GUI Will Not Run

If the GUI will not run, check the following:

- Are the cluster daemons running?

When you first install the software, the following daemons should be running:

- fs2d
- cmond
- cad
- crsd

To determine which daemons are running, enter the following:

```
# ps -ef | grep cluster
```

The following shows an example of the output when just the initial daemons are running; for readability, whitespace has been removed and the daemon names are highlighted:

```
fs6 # ps -ef | grep cluster
root 31431      1 0 12:51:36 ?      0:14 /usr/lib32/cluster/cbe/fs2d /var/cluster/cdb/cdb.db #
root 31456 31478 0 12:53:01 ?      0:03 /usr/cluster/bin/crsd -l
root 31475 31478 0 12:53:00 ?      0:08 /usr/cluster/bin/cad -l -lf /var/cluster/ha/log/cad_log --append_log
root 31478      1 0 12:53:00 ?      0:00 /usr/cluster/bin/cmond -L info -f /var/cluster/ha/log/cmond_log
root 31570 31408 0 14:01:52 pts/0 0:00 grep cluster
```

If you do not see these processes, go to the logs to see what the problem might be. If you must restart the daemons, enter the following:

```
# /etc/init.d/cluster start
```

- Are the tcpmux and tcpmux/sgi\_sysadm services enabled in the /etc/inetd.conf file?

The following line is added to the /etc/inetd.conf file when sysamd\_base is installed:

```
tcpmux/sgi_sysadm stream tcp nowait root    ?/usr/sysadm/bin/sysadmd sysadmd
```

If the `tcpmux` line is commented out, you must uncomment it and then run the following:

```
# kill -HUP inetd
```

- Are the `inetd` or `tcp` wrappers interfering? This may be indicated by `connection refused` or `login failed` messages.
- Are you connecting to an IRIX node? The `fsmgr` command can only be executed on an IRIX node. The GUI may be run from a node running an operating system other than IRIX via the Web if you connect the GUI to an IRIX node.

## GUI and `cmgr` Inconsistencies

If the GUI is displaying information that is inconsistent with the FailSafe `cmgr` command, restart `cad` process on the node to which GUI is connected to by executing the following command:

```
# killall cad
```

The cluster administration daemon is restarted automatically by the `cmnd` process.

## GUI Does Not Report Information

If the GUI is not reporting configuration information and status, perform the following steps:

1. Check the information using the `cmgr` command. If `cmgr` is reporting correct information, there is a GUI update problem.
2. If there is a GUI update problem, kill the `cad` daemon on that node. Wait for a few minutes to see whether `cad` gets correct information. Check the `cad` logs on that node for errors.
3. Check the CLI logs on that node for errors.
4. If the status information is incorrect, check the `cmsd` or `fsd` logs on that node.

## Using the `cdbreinit` Command

When the cluster databases are not in synchronization on all the nodes in the cluster, you can run the `cdbreinit` command to recover. The `cdbreinit` command should be run on the node which is not in sync.

Perform the following steps.

---

**Note:** Perform each step on all the nodes before proceeding to the next step in the recovery procedure.

---

1. Stop FailSafe HA services in the cluster using the GUI or `cmgr`.
2. Stop cluster processes on all nodes in the pool:

```
# /etc/init.d/cluster stop
# killall fs2d
```
3. Run `cdbreinit` on the node where the cluster database is not in sync.
4. Start cluster processes on all nodes in the pool:

```
# /etc/init.d/cluster start
```
5. Wait a few minutes for the cluster database to synchronize. There will be cluster database sync long messages in the `SYSLOG` on the node.
6. Start FailSafe HA services in the cluster.

## Action Script Configuration Errors

If you try to execute an action script that is missing or does not have the correct permissions, you will get an error message (see "ha\_srmd Error Message" on page 409.) After fixing the problem, you must send a `SIGHUP` signal to the `ha_srmd` process on each node so that it rereads the configuration. Use the following command line on each node:

```
# killall -HUP ha_srmd
```

When `ha_srmd` receives the `SIGHUP` signal, it will reread the resource type configuration. If `ha_srmd` finds errors in the resource type configuration, the errors will be logged in the `SYSLOG` or `ha_srmd` logs.

## CXFS Metadata Server Relocation

FailSafe uses a `umount` command with the `-k` option to move a resource in the case of a CXFS metadata server relocation if the `relocate-mds` attribute in the CXFS resource definition is set to `true`. The `umount -k` command will kill all server process using the CXFS filesystem.

## Other Problems with CXFS Coexecution

For information solving problems involving coexecution with CXFS, see the troubleshooting chapter of the *CXFS Administration Guide for SGI InfiniteStorage*.

## Reporting Problems to SGI

When reporting a problem about a FailSafe node to SGI, you should retain the following information:

- System core files in `/var/adm/crash`, including:

```
analysis.number  
unix.number  
vmcore.number.comp
```

- Output about the cluster obtained from the `cxfsdump` utility, which is shipped in the `cluster_services.sw.base` software product. (Although it was written primarily for CXFS, it also provides cluster information applicable to FailSafe.) You can run this utility immediately after noticing a problem. It collects the following:

- Information from the following files:

```
/var/adm/SYSLOG  
/var/cluster/ha/log/*  
/etc/failover.conf  
/var/sysgen/stune  
/etc/hosts
```

- Output from the following commands:

```
/usr/cluster/bin/cdbutil gettree '#'  
/usr/sbin/versions -n  
/usr/sbin/systune
```

```
/sbin/hinv -vm  
/sbin/xvm show -v phys  
/sbin/xvm show -top -v vol  
/usr/sbin/scsifo -d  
/usr/etc/netstat -ia
```

## Upgrading and Maintaining Active Clusters

When a FailSafe system is running, you may need to perform various administration procedures without shutting down the entire cluster. This chapter provides instructions for performing upgrade and maintenance procedures on active clusters. It includes the following:

- "Adding a Node to an Active Cluster"
- "Deleting a Node from an Active Cluster" on page 373
- "Changing Control Networks in a Cluster" on page 375
- "Upgrading OS Software in an Active Cluster" on page 377
- "Upgrading FailSafe Software in an Active Cluster" on page 378
- "Adding New Resource Groups or Resources in an Active Cluster" on page 379
- "Adding a New Hardware Device in an Active Cluster" on page 380

### Adding a Node to an Active Cluster

Use the following procedure to add a node to an active cluster. This procedure assumes that `cluster_admin`, `cluster_control`, `cluster_ha`, and `failsafe2` products are already installed in this node.

1. Check control network connections from the node to the rest of the cluster using `ping` command. Note the list of control network IP addresses.
2. Check the serial connections to reset this node. Note the name of the node that can reset this node.
3. Run node diagnostics. For information on FailSafe diagnostic commands, see Chapter 9, "Testing the Configuration" on page 337.
4. Make sure that the `sgi-cad`, `sgi-crsd`, `sgi-cmsd`, and `sgi-gcd` entries are present in the `/etc/services` file. The port numbers for these processes should match the port numbers in other nodes in the cluster.

## Example entries:

```
sgi-cad          7200/tcp      # Cluster admin daemon
sgi-crsd         7500/udp      # Cluster reset services daemon
sgi-cmsd         7000/udp      # FailSafe membership Daemon
sgi-gcd          8000/udp      # Group communication Daemon
```

5. Check if the HA services and cluster processes (cad, cmond, crsd) are running.

```
# ps -ef | grep cad
```

If HA services and cluster processes are not running, run the `cdbreinit` command. For example:

```
# /usr/cluster/bin/cdbreinit /var/cluster/cdb/cdb.db
Killing fs2d...
Removing database header file /var/cluster/cdb/cdb.db...
Preparing to delete database directory /var/cluster/cdb/cdb.db# !!
Continue[y/n]y
Removing database directory /var/cluster/cdb/cdb.db#...
Deleted CDB database at /var/cluster/cdb/cdb.db
Recreating new CDB database at /var/cluster/cdb/cdb.db with cdb-exitop...
  fs2d
Created standard CDB database in /var/cluster/cdb/cdb.db

Please make sure that "sgi-cad" service is added to /etc/services file
If not, add the entry and restart cluster processes.
Please refer to SGI FailSafe administration manual for more
information.

Modifying CDB database at /var/cluster/cdb/cdb.db with cluster_ha-exitop...
Modified standard CDB database in /var/cluster/cdb/cdb.db

Please make sure that "sgi-cmsd" and "sgi-gcd" services are added
to /etc/services file before starting HA services.
Please refer to SGI FailSafe administration manual for more
information.

Starting cluster control processes with cluster_control-exitop...

Please make sure that "sgi-crsd" service is added to /etc/services file
If not, add the entry and restart cluster processes.
Please refer to SGI FailSafe administration manual for more
```



information.

Started cluster control processes

Restarting cluster admin processes with failsafe-exitop...

6. Use the GUI, the `cmgr` command, or the template script (`/var/cluster/cmgr-templates/cmgr-create-node`) to define the node.

---

**Note:** This node must be defined from one of nodes that is already in the cluster.

---

7. Use the `cmgr` command or the GUI to add the node to the cluster.

For example: the following `cmgr` command adds the node `web-node3` to the cluster `web-cluster`:

```
cmgr> modify cluster web-cluster
Enter commands, when finished enter either "done" or "cancel"

web-cluster ? add node web-node3
web-cluster ? done
```

8. Start highly available (HA) services on this node using the `cmgr` command or the GUI.

For example, the following `cmgr` command starts HA services on node `web-node3` in cluster `web-cluster`:

```
cmgr> start ha_services on node web-node3 in cluster web-cluster
```

9. Add this node to the failure domain of the relevant failover policy. In order to do this, you must redefine the entire failover policy to include the additional node in the failure domain.

## Deleting a Node from an Active Cluster

Use the following procedure to delete a node from an active cluster. This procedure assumes that the node status is UP.

1. If resource groups are online on the node, use the `cmgr` command or the GUI to move them to another node in the cluster.

To move the resource groups to another node in the cluster, there should be another node available in the failover policy domain of the resource group. If you want to leave the resource groups running in the same node, use the `cmgr` command or the GUI to detach the resource group.

For example, the following command would leave the resource group `web-rg` running in the same node in the cluster `web-cluster`.

```
cmgr> admin detach resource_group web-rg in cluster web-cluster
```

2. Delete the node from the failure domains of any failover policies that use the node. In order to do this, the entire failover policy must be redefined, deleting the affected node from the failure domain.
3. Stop HA services on the node.

For example, to stop HA services on the node `web-node3`, use the following `cmgr` command. This command will move all the resource groups online on this node to other nodes in the cluster if possible:

```
cmgr> stop ha_services on node web-node3 for cluster web-cluster
```

If it is not possible to move resource groups that are online on node `web-node3`, the above command will fail. The `force` option is available to stop HA services in a node even in the case of an error. If there are resources that cannot be moved offline or deallocated properly, a side-effect of the offline force command will be to leave these resources allocated on the node.

Perform Steps 4, 5, 6, and 7 if the node must be deleted from the cluster database.

4. Delete the node from the cluster.

For example, to delete node `web-node3` from `web-cluster` configuration, use the following `cmgr` command:

```
cmgr> modify cluster web-cluster
Enter commands, when finished enter either "done" or "cancel"

web-cluster ? remove node web-node3
web-cluster ? done
```

5. Remove node configuration from the cluster database.

The following `cmgr` command deletes the `web-node3` node definition from the cluster database:

```
cmgr> delete node web-node3
```

6. Stop all cluster processes and delete the cluster database:

```
# /etc/init.d/cluster stop
# killall fs2d
# cdbdelete /var/cluster/cdb/cdb.db
```

7. Disable cluster and HA processes from starting when the node boots:

```
# chkconfig cluster off
# chkconfig failsafe2 off
```

## Changing Control Networks in a Cluster

Use the following procedure to change the control networks in a currently active cluster. This procedure is valid for a two-node cluster consisting of nodes `node1` and `node2`. In this procedure, you must complete each step before proceeding to the next step.

---

**Note:** Do not perform any other administration operations during this procedure.

---

1. From either node, stop HA services on the cluster. Make sure all HA processes have exited on both nodes.
2. From `node2`, stop the cluster processes on `node2`:

```
# /etc/init.d/cluster stop
# killall fs2d
```

Make sure the `fs2d` process have been killed on `node2`.

3. From `node1`, modify the `node1` and `node2` definition. Use the GUI or the following `cmgr` commands:

```
cmgr> modify node node1
Enter commands, when finished enter either "done" or "cancel"
node1?> remove nic old_nic_address
```

```
node1> add nic new_nic_address  
NIC - new_nic_address set heartbeat to ...  
NIC - new_nic_address set ctrl_msgs to ...  
NIC - new_nic_address set priority to ...  
NIC - new_nic_address done  
node1? done
```

Repeat the same procedure to modify node2.

4. From node1, check if the node1 and node2 definitions are correct. Using cmgr on node1, execute the following commands to view the node definitions:

```
cmgr> show node node1  
cmgr> show node node2
```

5. On both node1 and node2, modify the network interface IP addresses in /etc/config/netif.options and execute ifconfig to configure the new IP addresses on node1 and node2. Verify that the IP addresses match the node definitions in the cluster database.
6. From node1, stop the cluster process on node1:

```
# /etc/init.d/cluster stop  
# killall fs2d
```

Make sure the fs2d process have been killed on node1.

7. From node2, execute the following command to start cluster process on node2:

```
# /usr/cluster/bin/cdbreinit /var/cluster/cdb/cdb.db
```

Answer **y** to the prompt.

8. From node1, start cluster processes on node1:

```
# /etc/init.d/cluster start
```

The following messages should appear in the SYSLOG on node2:

```
Starting to receive CDB sync series from machine <node1_nodeID>  
...  
Finished receiving CDB sync series from machine <node1_nodeID>
```

Wait for approximately 60 seconds for the synchronization to complete.

9. From any node, start HA services in the cluster.

## Upgrading OS Software in an Active Cluster

Use the following procedure on one node at a time if the OS software upgrade requires a reboot or will impact the FailSafe software. If you are uncertain, you should use this procedure

The following procedure upgrades the OS software on node `web-node3`:

1. If resource groups are online on the node, use a `cmgr` command or the GUI to move them another node in the cluster. To move the resource group to another node in the cluster, there should be another node available in the failover policy domain of the resource group.

The following `cmgr` command moves resource group `web-rg` to another node in the cluster `web-cluster`:

```
cmgr> admin move resource_group web-rg in cluster web-cluster
```

2. To stop HA services on the node `web-node3`, use the following `cmgr` command or the GUI. This command will move all the resource groups online on this node to other nodes in the cluster if possible.

```
cmgr> stop ha_services on node web-node3 for cluster web-cluster
```

If it is not possible to move resource groups that are online on node `web-node3`, the above command will fail. You can use the `force` option to stop HA services in a node even in the case of an error.

3. Perform the OS upgrade in the node `web-node3`.
4. After the OS upgrade, make sure cluster processes (`cmond`, `cad`, `crsd`) are running.
5. Restart HA services on the node. For example, the following `cmgr` command restarts HA services on the node:

```
cmgr> start ha_services on node web-node3 for cluster web-cluster
```

Make sure the resource groups are running on the most appropriate node after restarting HA services.

## Upgrading FailSafe Software in an Active Cluster

When you upgrade FailSafe software in an active cluster, you upgrade one node at a time in the cluster.

The following procedure upgrades FailSafe on node `web-node3`:

1. If resource groups are online on the node, use a `cmgr` command or the GUI to move them another node in the cluster. To move the resource group to another node in the cluster, there should be another node available in the failover policy domain of the resource group.

For example, the following `cmgr` command moves resource group `web-rg` to another node in the cluster `web-cluster`:

```
cmgr> admin move resource_group web-rg in cluster web-cluster
```

2. To stop HA services on the node `web-node3`, use the following `cmgr` command or the GUI. This command will move all the resource groups online on this node to other nodes in the cluster if possible:

```
cmgr> stop ha_services on node web-node3 for cluster web-cluster
```

If it is not possible to move resource groups that are online on node `web-node3`, the above command will fail. You can use the `force` option to stop HA services in a node even in the case of an error.

3. Stop all cluster processes running on the node:

```
# /etc/init.d/cluster stop
```

4. Perform the FailSafe upgrade in the node `web-node3`.

5. After the FailSafe upgrade, check whether cluster processes (`cmond`, `cad`, `crsd`) are running. If not, restart cluster processes:

```
# chkconfig cluster on; /etc/init.d/cluster start
```

6. Restart HA services on the node. For example, the following `cmgr` command restarts HA services on the node:

```
cmgr> start ha_services on node web-node3 for cluster web-cluster
```

Make sure the resource groups are running on the most appropriate node after restarting HA services.

## Adding New Resource Groups or Resources in an Active Cluster

The following procedure adds a resource group and resources to an active cluster. To add resources to an existing resource group, perform resource configuration (Step 4), perform resource diagnostics (Step 5), and add resources to the resource group (Step 6).

1. Identify all the resources that have to be moved together. These resources running on a node should be able to provide a service to the client. These resources should be placed in a resource group. For example, Netscape webserver `mfg-web`, its highly available (HA) IP address `192.26.50.40`, and the filesystem `/shared/mfg-web` containing the Web configuration and document pages should be placed in the same resource group (for example, `mfg-web-rg`).
2. Configure the resources in all nodes in the cluster where the resource group is expected to be online. For example, this might involve configuring Netscape Web server `mfg-web` on nodes `web-node1` and `web-node2` in the cluster.
3. Create a failover policy. Determine the type of failover attribute required for the resource group. You can use the following `cmgr` template to create the failover policy:

```
/var/cluster/cmgr-templates/cmgr-create-failover_policy
```

4. Configure the resources in cluster database. There are `cmgr` templates to create resources of various resource types in `/var/cluster/cmgr-templates` directory. For example, the volume resource, the `/shared/mfg-web` filesystem, the `192.26.50.40` IP\_address resource, and the `mfg-web` Netscape\_web resource have to be created in the cluster database. Create the resource dependencies for these resources.
5. Run resource diagnostics. For information on the diagnostic commands, see Chapter 9, "Testing the Configuration" on page 337.
6. Create resource group and add resources to the resource group. You can use the following `cmgr` template to create resource group and add resources to resource group:

```
/var/cluster/cmgr-templates/cmgr-create-resource_group
```

All resources that are dependent on each other should be added to the resource group at the same time. If resources are added to an existing resource group that is online in a node in the cluster, the resources are also made online on the same node.

## Adding a New Hardware Device in an Active Cluster

You will add new hardware devices to an active cluster one node at a time.

To add hardware devices to a node in an active cluster, follow the same procedure as when you upgrade OS software in an active cluster, as described in "Upgrading OS Software in an Active Cluster" on page 377. In summary:

- You must move the resource groups offline and stop HA services in the node before adding the hardware device.
- After adding the hardware device, make sure cluster processes are running and start HA services on the node.

To include the new hardware device in the cluster database, you must modify your resource configuration and your node configuration, where appropriate.



## Performance Co-Pilot for FailSafe

This chapter tells you how to use Performance Co-Pilot for FailSafe to monitor the availability of a FailSafe cluster. For information about installing Performance Co-Pilot for FailSafe, see "Install Performance Co-Pilot Software" on page 109.

Performance Co-Pilot provides the following:

- An agent for exporting FailSafe heartbeat and resource monitoring statistics to the Performance Co-Pilot framework
- 3-D visualization tools for displaying these statistics in an intuitive presentation

The visualization of statistics provides valuable information about the availability of nodes and resources monitored by FailSafe. For example, it can highlight a reduction in monitoring response times that may indicate problems in availability of services provided by the cluster.

Because Performance Co-Pilot for FailSafe is an extension to the Performance Co-Pilot framework, you can use other Performance Co-Pilot tools to analyze or present FailSafe monitoring statistics, and record Performance Co-Pilot for FailSafe metrics as archives for deferred analysis. You can also use Performance Co-Pilot to gather statistics about CPU and memory utilization, network and disk activity, and other performance metrics for each node in the cluster.

### Using the Visualization Tools

To view statistics about the FailSafe cluster, use the `rmvis` and `hbvis` commands.

The `hbvis` command constructs a display showing the distribution of heartbeat response times for every node in the cluster. Figure 12-1 shows an example display.

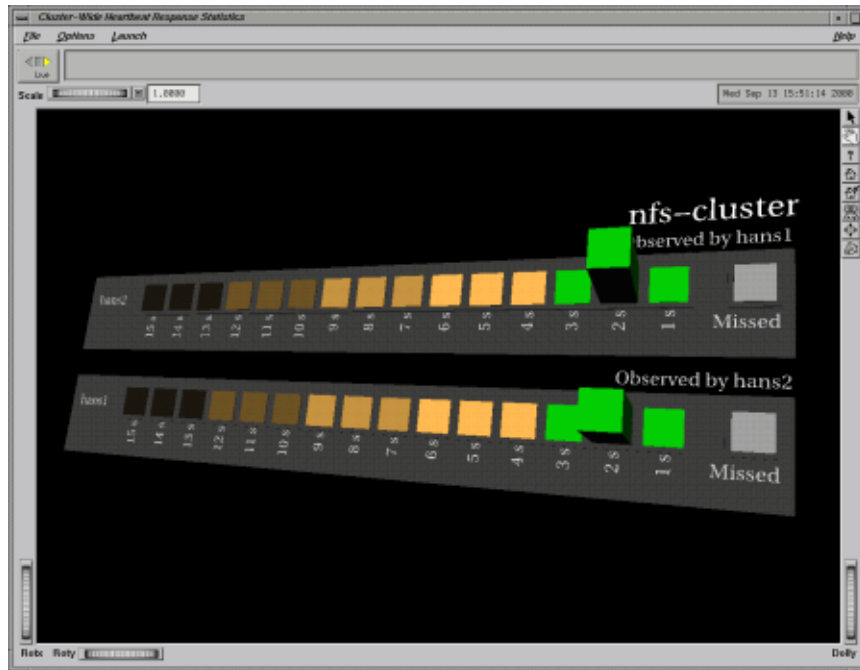

**Figure 12-1** Heartbeat Response Statistics

Key features of the display include the frequency of heartbeat responses that arrive at particular intervals within the timeout period and the frequency of heartbeat responses that have been missed (determined not to have arrived). The bar representing the frequency of missed heartbeat responses changes color to indicate the urgency of problems with availability of a node.

The `rmvis` command constructs a display of the resource monitoring response times for resources monitored on every node of the cluster. Figure 12-2 shows an example display.

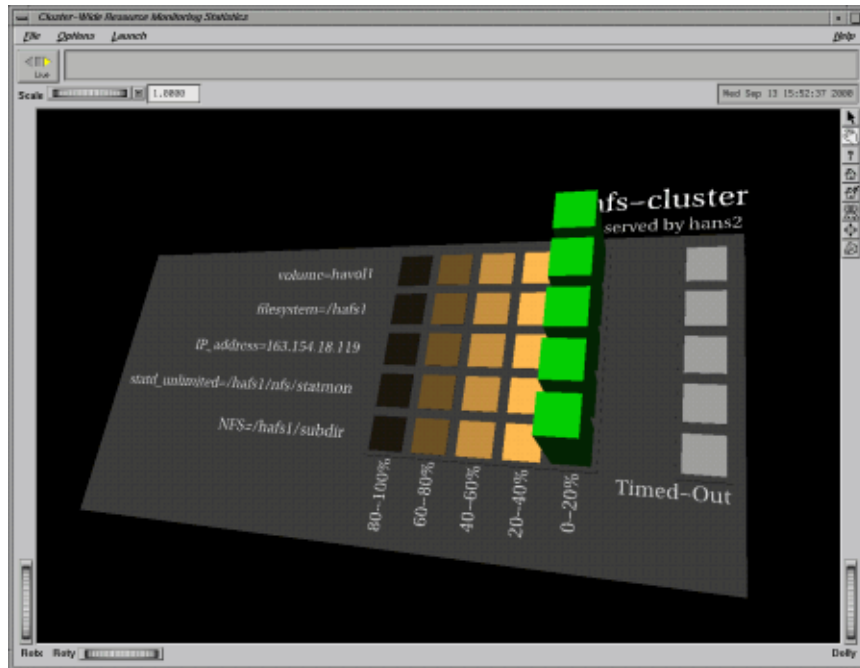

**Figure 12-2** Resource Monitoring Statistics

The display is similar in concept to that of `hbvis`, showing the frequency of resource monitoring responses that arrive within the timeout period, and the frequency of responses that have timed out. The bar representing the frequency of resource responses that have timed out also changes color to indicate the urgency of problems with the availability of particular resources.

If a node has failed or a resource has failed over, its statistics will disappear from the display.

To run a visualization tool on the monitor host, use the `-h` option to specify an available collector host in the cluster (*host*):

```
% hbvis -h host
```

or

```
% rmvis -h host
```

The collector host specified can be **any** collector host that is a member of the cluster for which you wish to view statistics.

You can also access these tools from the following FailSafe GUI menus:

**File**  
    > **Launch Resource Monitoring**

**File**  
    > **Launch Heartbeat Monitoring**

There are various options available to alter the display provided by `hbvis` and `rmvis` when launched from the command line:

- H *hostfile*                      Provides a file that lists the nodes that are to appear in the visualization. This is useful in limiting the number of nodes in the display, because it takes more time to construct the display for clusters with more nodes.
  
- t *interval*                      Assigns the sampling time of the visualization. There may be circumstances where extending the period of the sampling time may provide better application responsiveness, particularly for clusters with many nodes. Because FailSafe maintains the statistics, `hbvis` and `rmvis` will always show the latest statistics available for the sampling time selected. For details about the *interval* option, see the `pmview` and `PCPIntro` man pages.
  
- r                                      Selects the FailSafe metrics that present a sampling of statistics taken from the time of the last statistical reset. This enables `hbvis` and `rmvis` to improve the sensitivity of the visualization when abrupt changes appear in the FailSafe monitoring statistics.  
  
Without the `-r` option, the statistics presented are from a sampling of FailSafe metrics collected from the time `ha_cmsd` and/or `ha_srmd` was last restarted.
  
- R                                      Starts a new statistical sampling.
  
- v                                      (`hbvis` only) Provides a visualization of heartbeat statistics for each node in the cluster, from the point of view of the selected collector host only. (The collector host is selected using the `-h` option). There is a

graphical representation of heartbeat statistics for each node in the cluster as observed by the selected collector host.

- `-w` (hbvis only) Provides a visualization of the aggregate of heartbeat statistics for all nodes in the cluster, from the point of view of the selected collector host only. (The collector host is selected using the `-h` option). There is a only one graphical representation of heartbeat statistics for the entire cluster as observed by the selected collector host.

For a complete description of options, see the `hbvis` and `rmvis` man pages.

The `hbvis` and `rmvis` commands use the command `pmview` to display the 3-D visualization of FailSafe performance metrics. For a description of the various menu commands and controls in the visualization window, consult the man page for `pmview`.

## Performance Co-Pilot for FailSafe Performance Metrics

Performance Co-Pilot tools such as `pmlogger`, `pmchart`, and `pminfo` can use the metrics exported by Performance Co-Pilot for FailSafe.

Appendix B, "Metrics Exported by Performance Co-Pilot for FailSafe" on page 393, provides a description of Performance Co-Pilot for FailSafe metrics. You can also display a description of metrics by using the following command:

```
% pminfo -tT -h host
```

(If you are logged in to a collector host, you can leave out the `-h` option).

## Performance Co-Pilot Gray Display

A gray display (that is, no colored rectangle bars appear on the node's gray baseplane) when using `hbvis` or `rmvis` may indicate one of the following:

- The node is down.

If you wish to see only the nodes that are up, create a file containing a list of nodes that are to be displayed and pass it as an option to `hbvis`/`rmvis` using the

-H option (or the environment variable `PCP_FSAFE_NODES`) so that a new picture of the cluster can be generated. Please refer to the `hbvis/rmvis` man pages for more details on the -H option.

- The collector daemons have been killed on that node.

To solve this problem, restart `pmdafsafe` in one of the following ways:

- If `pmcd` is still running, send `pmcd` the `SIGHUP` signal by entering the following:

```
# killall -HUP pmcd
```

- If `pmcd` is not running, restart Performance Co-Pilot by entering the following:

```
# /etc/init.d/pcp start
```

- The timeout and sampling settings are too short.

To change the sampling time, use the time controls available in the `pmview` window. By default, this is two seconds; you may need to lengthen the sampling period if you are getting an unsatisfactory display.

Alternatively, there may be timeout issues between `pmdafsafe` and `pmcd`, or between `pmcd` and `pmview`. Refer to the man pages for `pmcd` and `PCPIntro` for information on how to change the timeout settings for the various Performance Co-Pilot tools.

- The resource has failed over (for `rmvis`).

In this case, restart `rmvis` so that a new picture of the cluster can be generated.

## FailSafe Software

This appendix summarizes software to be installed on systems used for FailSafe. It consists of the following sections:

- "Subsystems on the CD"
- "Subsystems for Servers and Workstations in the Pool" on page 389
- "Additional Subsystems for Nodes in the FailSafe Cluster" on page 390
- "Additional Subsystems for Workstations " on page 390

---

**Note:** "Install FailSafe" on page 87 contains step-by-step instructions for installing the software.

---

### Subsystems on the CD

The FailSafe base CD requires about 10 MB.

Table A-1 on page 388, lists FailSafe subsystems on the FailSafe CD.

**Table A-1** FailSafe CD

Purpose	System
IRIS FailSafe 2.1.x	failsafe2 failsafe2.idb failsafe2.man failsafe2.sw failsafe2.books (InSight versions of customer manuals)
FailSafe system administration	sysadm_failsafe2 sysadm_failsafe2.idb sysadm_failsafe2.man sysadm_failsafe2.sw

Users must install base system administration (`sysadm_base`), cluster administration (`sysadm_cluster.sw` and `cluster_admin`), cluster control (`cluster_control`), cluster services (`cluster_services`), java (`java_eoe`), and Java Plug-in (`java_plugin`) from the IRIX CD set.

The Etherlite network based serial multiplexer driver subsystems are `el_serial.man` and `el_serial.sw`, which are on a CD accompanying the multiplexer.



## Subsystems for Servers and Workstations in the Pool

The following table lists subsystems required for servers and workstations in the pool. The pool is the entire set of servers available for clustering (nodes). It includes servers and the workstation(s) used for administering the cluster

**Table A-2** Subsystems Required for Nodes in the Pool (Servers and GUI Client(s))

Product	Images and Subsystems	Prerequisites
Base system administration	sysadm_base.sw.dso	None
Base system administration server	sysadm_base.sw.server	sysadm_base.sw.dso
Cluster administration GUI	sysadm_cluster.sw.server	sysadm_base.sw.server
IRIS FailSafe 2.1.x administration server	sysadm_failsafe2.sw.server	sysadm_base.sw.server sysadm_cluster.sw.server cluster_admin.sw.base cluster_services.sw.cli cluster_control.sw.cli failsafe2.sw
Cluster administration	cluster_admin.sw cluster_control.sw	sysadm_base.sw.dso
Web-based administration	sysadm_failsafe2.sw.web	sysadm_failsafe2.sw.client sysadm_failsafe2.sw.server sysadmbase.sw.client java_eoe.sw, version 3.1.1 Web server
Etherlite network-based serial multiplexer driver (from CD included with multiplexer)	el_serial.man el_serial.sw	

## Additional Subsystems for Nodes in the FailSafe Cluster

The following table lists additional subsystems required for each server that is a node in the cluster. A cluster is one or more nodes coupled with each other by networks. A node is a single UNIX image, usually, an individual server. A node can be a member of only one cluster.

**Table A-3** Additional Subsystems Required for Nodes in the Cluster

Product	Images and Subsystems	Prerequisites
Highly available clustering software	cluster_services.sw	cluster_admin.sw cluster_control.sw
IRIS FailSafe 2.1.x software	failsafe2.sw	cluster_services.sw

## Additional Subsystems for Workstations

On a workstation used to run the GUI client, you must install subsystems depending on the type of workstation. The following sections provide a list of the subsystems to install on the following:

- IRIX workstations
- Other operating system workstations

## Subsystems for IRIX Workstations

On a workstation used to run the GUI client from an IRIX desktop, install subsystems listed in the following table.

**Table A-4** Subsystems Required for IRIX Workstations

Product	Subsystems	Prerequisites
Cluster administration GUI	sysadm_cluster.sw.client	sysadm_base.sw.client
FailSafe GUI	sysadm_failsafe2.sw.client sysadm_failsafe2.sw.desktop	sysadm_base.sw.client sysadm_cluster.sw.client java_eoe.sw, version 3.1.1
Java Plug-in (required only if the workstation is used to launch the GUI client from a Web browser that supports Java)	java_plugin.sw java_plugin.sw32	Web browser that supports Java

## Subsystems for Other Operating System Workstations

From a workstation running an operating system other than IRIX, the GUI can be launched from a web browser that supports Java.



## Metrics Exported by Performance Co-Pilot for FailSafe

This appendix lists the metrics implemented by `pmdafsafe`.

`fsafe.srm.all.*` metrics are the same as the `fsafe.srm.*` metrics, except that the latest values obtained for all resources will be available, even if `ha_srmd` or any of the resources themselves are not available.

**Table B-1** Performance Co-Pilot Metrics

Metric	Description
<code>fsafe.srm.status</code> <code>fsafe.srm.all.status</code>	Latest status of a monitoring event performed on a resource, for all resources configured to be monitored on this node.
<code>fsafe.srm.timeout</code> <code>fsafe.srm.all.timeout</code>	The prescribed timeout, in milliseconds, for monitoring a resource.
<code>fsafe.srm.probes</code> <code>fsafe.srm.all.probes</code>	Number of times a resource has been monitored, for all resources configured to be monitored on this node, since the time <code>ha_srmd</code> was started.
<code>fsafe.srm.recent.probes</code>	Number of times a resource has been monitored, for all resources configured to be monitored on this node, since a data collection reset (via <code>fsafe.control.reset_srm</code> ).
<code>fsafe.srm.timeouts</code> <code>fsafe.srm.all.timeouts</code>	Number of resource monitoring events that have timed out before declaring that resource as failed, for all resources configured to be monitored on this node, since the time the resources have last been available.
<code>fsafe.srm.recent.timeouts</code>	Number of resource monitoring events that have timed out before declaring that resource as failed, for all resources configured to be monitored on this node, since a data collection reset (via <code>fsafe.control.reset_srm</code> ).

## B: Metrics Exported by Performance Co-Pilot for FailSafe

---

Metric	Description
<code>fsafe.srm.min_resp</code> <code>fsafe.srm.all.min_resp</code>	Approximate minimum time, in milliseconds, taken to complete a monitoring event on a resource, for all resources configured to be monitored.
<code>fsafe.srm.max_resp</code> <code>fsafe.srm.all.max_resp</code>	Approximate maximum time, in milliseconds, taken to complete a monitoring event on a resource, for all resources configured to be monitored on this node.
<code>fsafe.srm.last_resp</code> <code>fsafe.srm.all.last_resp</code>	Approximate time, in milliseconds, taken in completing the most recent monitoring event on a resource, for all resources configured to be monitored on this node.
<code>fsafe.srm.cumm_timeouts</code> <code>fsafe.srm.all.cumm_timeouts</code>	Cumulative number of resource monitoring events that have timed out, for all resources configured to be monitored on this node, since the time <code>ha_srm</code> has started.
<code>fsafe.srm.recent.cumm_timeouts</code>	Cumulative number of resource monitoring events that have timed out, for all resources configured to be monitored on this node, since a data collection reset (via <code>fsafe.control.reset_srm</code> ).
<code>fsafe.srm.histo_20</code> <code>fsafe.srm.all.histo_20</code>	Fraction of monitoring events that have been received within 0-20% of the response time from 0 milliseconds to <code>fsafe.srm.timeout</code> , for all resources configured to be monitored on this node, since the time <code>ha_srm</code> has started.
<code>fsafe.srm.recent.histo_20</code>	Fraction of monitoring events that have been received within 0-20% of the response time from 0 milliseconds to <code>fsafe.srm.timeout</code> , for all resources configured to be monitored on this node, since a data collection reset (via <code>fsafe.control.reset_srm</code> ).
<code>fsafe.srm.histo_40</code> <code>fsafe.srm.all.histo_40</code>	Fraction of monitoring events that have been received within 20-40% of the response time from 0 milliseconds to <code>fsafe.srm.timeout</code> , for all resources configured to be monitored on this node, since the time <code>ha_srm</code> has started.

Metric	Description
<code>fsafe.srm.recent.histo_40</code>	Fraction of monitoring events that have been received within 20-40% of the response time from 0 milliseconds to <code>fsafe.srm.timeout</code> , for all resources configured to be monitored on this node, since a data collection reset (via <code>fsafe.control.reset_srm</code> ).
<code>fsafe.srm.histo_60</code> <code>fsafe.srm.all.histo_60</code>	Fraction of monitoring events that have been received within 40-60% of the response time from 0 milliseconds to <code>fsafe.srm.timeout</code> , for all resources configured to be monitored on this node, since the time <code>ha_srm</code> (1M) has started.
<code>fsafe.srm.recent.histo_60</code>	Fraction of monitoring events that have been received within 40-60% of the response time from 0 milliseconds to <code>fsafe.srm.timeout</code> , for all resources configured to be monitored on this node, since a data collection reset (via <code>fsafe.control.reset_srm</code> ).
<code>fsafe.srm.histo_80</code> <code>fsafe.srm.all.histo_80</code>	Fraction of monitoring events that have been received within 60-80% of the response time from 0 milliseconds to <code>fsafe.srm.timeout</code> , for all resources configured to be monitored on this node, since the time <code>ha_srm</code> has started.
<code>fsafe.srm.recent.histo_80</code>	Fraction of monitoring events that have been received within 60-80% of the response time from 0 milliseconds to <code>fsafe.srm.timeout</code> , for all resources configured to be monitored on this node, since a data collection reset (via <code>fsafe.control.reset_srm</code> ).
<code>fsafe.srm.histo_100</code> <code>fsafe.srm.all.histo_100</code>	Fraction of monitoring events that have been received within 80-100% of the response time from 0 milliseconds to <code>fsafe.srm.timeout</code> , for all resources configured to be monitored on this node, since the time <code>ha_srm</code> has started.
<code>fsafe.srm.recent.histo_100</code>	Fraction of monitoring events that have been received within 80-100% of the response time from 0 milliseconds to <code>fsafe.srm.timeout</code> , for all resources configured to be monitored on this node, since a data collection reset (via <code>fsafe.control.reset_srm</code> ).

## B: Metrics Exported by Performance Co-Pilot for FailSafe

---

Metric	Description
<code>fsafe.srm.frac_timeouts</code> <code>fsafe.srm.all.frac_timeouts</code>	Fraction of monitoring events that have timed out before declaring that resource as failed, for all resources configured to be monitored on this node, since the time the resources have last been available.
<code>fsafe.srm.recent.frac_timeouts</code>	Fraction of monitoring events that have timed out, before declaring that resource as failed, for all resources configured to be monitored on this node, since a data collection reset (via <code>fsafe.control.reset_srm</code> ).
<code>fsafe.srm.frac_cumm_timeouts</code> <code>fsafe.srm.all.frac_cumm_timeouts</code>	Fraction of cumulative number of monitoring events that have timed out, for all resources configured to be monitored on this node, since the time <code>ha_srm</code> has started.
<code>fsafe.srm.recent.frac_cumm_timeouts</code>	Fraction of cumulative number of monitoring events that have timed out, for all resources configured to be monitored on this node, since a data collection reset (via <code>fsafe.control.reset_srm</code> ).
<code>fsafe.srm.recent.timestamp</code>	The time when a new collection of statistics was started for the <code>fsafe.srm.recent.*</code> metrics, after issuing a store to the metric <code>fsafe.control.reset_srm</code> .
<code>fsafe.config.clustername</code>	The name of this cluster.
<code>fsafe.config.hostname</code>	The name of all hosts in the cluster specified by <code>fsafe.config.clustername</code> .
<code>fsafe.config.nnodes</code>	Number of nodes in the cluster specified by <code>fsafe.config.clustername</code> .
<code>fsafe.config.cms.interval</code>	The cluster heartbeat event interval, in milliseconds.
<code>fsafe.config.cms.timeout</code>	The heartbeat event timeout for all nodes in the cluster, in milliseconds.
<code>fsafe.config.cms.nbuckets</code>	The number of heartbeat event response intervals per node, where each interval covers a time equal to the heartbeat event interval ( <code>fsafe.config.cms.interval</code> ) for segments of time until the heartbeat event timeout ( <code>fsafe.config.cms.timeout</code> ).



Metric	Description
<code>fsafe.control.debug</code>	<p>Debugging flags for the <code>fsafe</code> PMDA when a decimal integer value is stored to this metric. It ultimately affects what information is put into the <code>fsafe</code> PMDA's log (normally at <code>/var/adm/pcplog/fsafe.log</code>).</p> <p>Reading this metric will return the currently assigned debugging flags as a decimal integer.</p>
<code>fsafe.control.reset_cms</code>	<p>Resets data collection statistics for all metrics gathered from <code>ha_cmsd</code>. When this metric is stored to, the data provided is ignored; it is the act of storing to this metric which causes the reset.</p> <p>Reading this metric will return zero (0).</p>
<code>fsafe.control.reset_srm</code>	<p>Resets data collection statistics for all metrics gathered from <code>ha_srmd</code>. When this metric is stored, the data provided is ignored; it is the act of storing to this metric which causes the reset.</p> <p>Reading this metric will return zero (0).</p>
<code>fsafe.control.retry</code>	<p>Sets the number of retries permitted when contacting <code>ha_cmsd</code> or <code>ha_srmd</code>, and when the daemons indicate that they are busy.</p> <p>Depending on which metrics are being read, and which daemon is required to obtain values for the required metrics, values for some metrics may not be available, possibly producing the message "Try again. Information not currently available." This metric can be adjusted in order to increase the number of retries permitted when collecting metrics, before giving up and displaying this message. A retry is performed once every 100 ms (approximately).</p> <p>Note that setting this metric does not alter how the <code>fsafe</code> PMDA handles more serious errors from <code>ha_cmsd</code> or <code>ha_srmd</code>.</p> <p>Reading this metric will return the current retry count.</p>

Metric	Description
<code>fsafe.cms.expected</code>	The number of heartbeat events expected to have been received for each node in the cluster (excluding the collector host), since the time <code>ha_cmsd</code> has started.
<code>fsafe.cms.recent.expected</code>	The number of heartbeat events expected to have been received for each node in the cluster (excluding the collector host), since a data collection reset (via <code>fsafe.control.reset_cms</code> ).
<code>fsafe.cms.received</code>	The number of heartbeat events actually received for each node in the cluster (excluding the collector host), since the time <code>ha_cmsd</code> has started.
<code>fsafe.cms.recent.received</code>	The number of heartbeat events actually received for each node in the cluster (excluding the collector host), since a data collection reset (via <code>fsafe.control.reset_cms</code> ).
<code>fsafe.cms.missed</code>	The number of heartbeat events determined not to have been received for each node in the cluster (excluding the collector host), since the time <code>ha_cmsd</code> has started.
<code>fsafe.cms.recent.missed</code>	The number of heartbeat events determined not to have been received for each node in the cluster (excluding the collector host), since a data collection reset (via <code>fsafe.control.reset_cms</code> ).
<code>fsafe.cms.histo</code>	<p>Histogram of heartbeat event response times for events that have occurred within discrete heartbeat response intervals for each node in the cluster (excluding the collector host), since the time <code>ha_cmsd</code> has started.</p> <p>The heartbeat response intervals are defined to be equal to the configured heartbeat event interval (<code>fsafe.config.cms.interval</code>), for a number of intervals up to the configured heartbeat event timeout (<code>fsafe.config.cms.timeout</code>).</p>
<code>fsafe.cms.recent.histo</code>	Histogram of heartbeat event response times for events that have occurred within discrete heartbeat response intervals for each node in the cluster (excluding the collector host), since a data collection reset (via <code>fsafe.control.reset_cms</code> ).

Metric	Description
	The heartbeat response intervals are defined to be equal to the configured heartbeat event interval ( <code>fsafe.config.cms.interval</code> ), for a number of intervals up to the configured heartbeat event timeout ( <code>fsafe.config.cms.timeout</code> ).
<code>fsafe.cms.frac_received</code>	Fraction of heartbeat events received over all expected events for each node in the cluster, since the time <code>ha_cmsd</code> has started.
<code>fsafe.cms.recent.frac_received</code>	Fraction of heartbeat events received over all expected events for each node in the cluster, since a data collection reset (via <code>fsafe.control.reset_cms</code> ).
<code>fsafe.cms.frac_missed</code>	Fraction of heartbeat events determined not to have been received over all expected events for each node in the cluster, since the time <code>ha_cmsd</code> has started.
<code>fsafe.cms.recent.frac_missed</code>	Fraction of heartbeat events determined not to have been received over all expected events for each node in the cluster, since a data collection reset (via <code>fsafe.control.reset_cms</code> ).
<code>fsafe.cms.recent.timestamp</code>	The time when a new collection of statistics was started for the <code>fsafe.cms.recent.*</code> metrics, after issuing a store to the metric <code>fsafe.control.reset_cms</code> .
<code>fsafe.cms.pernode.expected</code>	The number of heartbeat events expected to have been received for a particular node in the cluster, since the time <code>ha_cmsd</code> has started.
<code>fsafe.cms.recent.pernode.expected</code>	The number of heartbeat events expected to have been received for a particular node in the cluster, since a data collection reset (via <code>fsafe.control.reset_cms</code> ).
<code>fsafe.cms.pernode.received</code>	The number of heartbeat events actually received for a particular node in the cluster, since the time <code>ha_cmsd</code> has started.
<code>fsafe.cms.recent.pernode.received</code>	The number of heartbeat events actually received for a particular node in the cluster, since a data collection reset (via <code>fsafe.control.reset_cms</code> ).

B: Metrics Exported by Performance Co-Pilot for FailSafe

---

Metric	Description
<code>fsafe.cms.pernode.missed</code>	The number of heartbeat events determined not to have been received for a particular node in the cluster, since the time <code>ha_cmsd</code> has started.
<code>fsafe.cms.recent.pernode.missed</code>	The number of heartbeat events determined not to have been received for a particular node in the cluster, since a data collection reset (via <code>fsafe.control.reset_cms</code> ).
<code>fsafe.cms.pernode.histo</code>	<p>Histogram of heartbeat event response times for events that have occurred within discrete heartbeat response intervals for a particular node in the cluster, since the time <code>ha_cmsd</code> has started.</p> <p>The heartbeat response intervals are defined to be equal to the configured heartbeat event interval (<code>fsafe.config.cms.interval</code>), for a number of intervals up to the configured heartbeat event timeout (<code>fsafe.config.cms.timeout</code>).</p>
<code>fsafe.cms.recent.pernode.histo</code>	<p>Histogram of heartbeat event response times for events that have occurred within discrete heartbeat response intervals for a particular node in the cluster, since a data collection reset (via <code>fsafe.control.reset_cms</code>).</p> <p>The heartbeat response intervals are defined to be equal to the configured heartbeat event interval (<code>fsafe.config.cms.interval</code>), for a number of intervals up to the configured heartbeat event timeout (<code>fsafe.config.cms.timeout</code>).</p>
<code>fsafe.cms.pernode.frac_received</code>	Fraction of heartbeat events received over all expected events for a particular node in the cluster, since the time <code>ha_cmsd</code> has started.
<code>fsafe.cms.recent.pernode.frac_received</code>	Fraction of heartbeat events received over all expected events for a particular node in the cluster, since a data collection reset (via <code>fsafe.control.reset_cms</code> ).
<code>fsafe.cms.pernode.frac_missed</code>	Fraction of heartbeat events determined not to have been received over all expected events for a particular node in the cluster, since the time <code>ha_cmsd</code> has started.

Metric	Description
<code>fsafe.cms.recent.pernode.frac_missed</code>	Fraction of heartbeat events determined not to have been received over all expected events for a particular node in the cluster, since a data collection reset (via <code>fsafe.control.reset_cms</code> ).



## System Messages

This appendix discusses the following:

- "SYSLOG Messages"
- "Log File Error Messages" on page 409

### SYSLOG Messages

FailSafe logs both normal operations and critical errors to SYSLOG, as well as to individual log files for each log group.

In general, errors in the SYSLOG file take the following form:

*timestamp priority\_&\_facility : hostname process[ID]: <internal\_info> CODE message\_text*

For example:

```
Sep  7 11:12:59 6X:fs0 cli[5830]: < E clconf 0> CI_IPCERR_NOSERVER, clconf
ipc: ipccInt_connect() failed, file /var/cluster/ha/comm/clconfd-ipc_fs0
```

The following table shows the parts of the preceding SYSLOG message.

**Table C-1** SYSLOG Error Message Format

Content	Part	Meaning
Sep 7 11:12:59	Timestamp	September 7 at 11:12 AM.
6X	Facility and level	6X indicates an informational message. See the <code>syslogd</code> man page and the file <code>/usr/include/sys/syslog.h</code> .
fs0	Node name	The node whose logical name is <code>fs0</code> is the node on which the process is running.
cli[5830]	Process[ID]	The process sending the message is <code>cli</code> and its process ID number is 5830.
<CI>E clconf 0	Internal information: message source, logging subsystem, and thread ID	The message is from the cluster infrastructure (CI). <code>E</code> indicates that it is an error. The <code>clconf</code> command is the logging subsystem. <code>0</code> indicates that it is not multithreaded.
CI_IPCERR_NOSERVER, clconf ipc	Internal error code	Information about the type of message; in this case, a message indicating that the server is missing. No error code is printed if it is a normal message.
ipcclnt_connect() failed, file /var/cluster/ha/comm/clconfd-ipc_fs0	Message text	A connection failed for the <code>clconfd-ipc_fs0</code> file.

Some of the following sections present only the message identifiers and text.



## Normal Messages After Successfully Starting HA Services

When you start HA services successfully, you will see a series of message. The following shows messages you would see after successfully starting HA services for nodes named hans1 and hans2 (line breaks added for readability):

```
Aug 14 15:01:23 6X:hans1 ha_cmsd[6431]: < N cms 0> FailSafe: ha_cmsd process started.
Aug 14 15:01:24 6X:hans1 ha_ifd[6430]: < N ifd 0> FailSafe: ha_ifd monitoring network interfaces
Aug 14 15:02:00 6X:hans1 ha_cmsd[6431]: < N cms 0> FailSafe Node Confirmed Membership: sqn 1 G_sqn = 1,
    ack false change 5
Aug 14 15:02:00 5B:hans1 Configuration changes
Aug 14 15:02:00 5B:hans1 Membership changes
Aug 14 15:02:00 5B:hans1 node hans1 [1] : UP incarnation 69 age 1:0
Aug 14 15:02:00 5B:hans1 node hans2 [2] : UP incarnation 168 age 1:0
Aug 14 15:02:04 6X:hans1 ha_gcd[6435]: < N gcd 0> FailSafe: ha_gcd initialization complete
Aug 14 15:02:17 6X:hans1 ha_srmd[6424]: < N srm 2> FailSafe: SRM ready to accept clients
Aug 14 15:02:48 6X:hans1 ha_fsd[6408]: < N fsd 0> FailSafe initialization complete
```

## cli Error Messages

For all cli messages, only the last message from the command (which begins with CLI private command failed) is meaningful. You can ignore all other cli messages.

The following are example errors from the cli daemon.

```
CI_ERR_INVALID, CLI private command: failed (Machine (fs0)
exists.)
```

You tried to create a new node definition with logical name fs0; however, that node name already exists in the cluster database. Choose a different name.

```
CI_ERR_INVALID, CLI private command: failed (IP address
(128.162.89.33) specified for control network is fs0 is assigned
to control network of machine (fs0).)
```

You specified the same IP address for two different control networks of node fs0. Use a different IP address.

CI\_FAILURE, CLI private command: failed (Unable to validate hostname of machine (fs0) being modified.)

The DNS resolution of the fs0 name failed. To solve this problem, add an entry for fs0 in /etc/hosts on all nodes.

CI\_IPCERR\_NOPULSE, CLI private command: failed (Cluster state is UNKNOWN.)

The cluster state is UNKNOWN and the command could not complete. This is a transient error. However, if it persists, stop and restart the cluster daemons.

## crsd Error Messages

The following errors are sent by the crsd daemon.

CI\_ERR\_NOTFOUND, No logging entries found for group crsd, no logging will take place - Database entry #global#logging#crsd not found.

No crsd logging definition was found in the cluster database. This can happen if you start cluster processes without creating the database.

CI\_ERR\_RETRY, Could not find machine listing.

The crsd daemon could not find the local node in the cluster database. You can ignore this message if the local node definition has not yet been created.

CI\_ERR\_SYS:125, bind() failed.

The sgi-crsd port number in the /etc/services file is not unique, or there is no sgi-crsd entry in the file.

CI\_FAILURE, Entry for sgi-crsd is missing in /etc/services.

The sgi-crsd entry is missing from the /etc/services file.

CI\_FAILURE, Initialization failed, exiting.

A sequence of messages will be ended with this message; see the messages prior to this one in order to determine the cause of the failure.

## cmond Error Messages

The following errors are sent by the cmond daemon.

```
Could not register for notification.cdb_error = 7
```

An error number of 7 indicates that the cluster database was not initialized when the cluster process was started.

This may be caused if you execute the `cdbreinit` on one administration node while some other administration nodes in the pool are still running `fs2d` and already have the node listed in the database.

Do the following:

1. Execute the following command on the nodes that show the error:

```
# /usr/cluster/bin/cdb-init-std-nodes
```

This command will recreate the missing nodes without disrupting the rest of the database.

2. If the error persists, force the daemons to restart by executing the following command:

```
# /etc/init.d/cluster restart
```

Verify that cmond is restarted.

3. If the error persists, reinitialize the database on just the node that is having problems.
4. If the error still persists, reinitialize all nodes in the cluster.

```
Process clconfd:343 of group cluster_cx exited, status = 3.
```

The `clconfd` process exited with status 3, meaning that the process will not be restarted by cmond. No corrective action is needed.

Process crsd:1790 of group cluster\_control exited, status = 127

The crsd process exited with an error (nonzero) status. Look at the corresponding daemon logs for error messages.

## fs2d Error Messages

The following errors are sent by the fs2d daemon.

Error 9 writing CDB info attribute for node  
#cluster#elaine#machines#fs2#HA#status

An internal error occurred when writing to the cluster database.  
Retry the operation. If the error persists, stop and restart the cluster daemons.

If the problem persists, clear the database, reboot, and re-create the database.

Error 9 writing CDB string value for node  
#cluster#elaine#machines#fs2#HA#status

An internal error occurred when writing to the cluster database.  
Retry the operation. If the error persists, stop and restart the cluster daemons.

If the problem persists, clear the database, reboot, and re-create the database.

Failed to update CDB for node  
#cluster#elaine#HA#FileSystems#fs1#FSStatus

An internal error occurred when writing to the cluster database.  
Retry the operation. If the error persists, stop and restart the cluster daemons.

If the problem persists, clear the database, reboot, and re-create the database.

Failed to update CDB for node  
#cluster#elaine#machines#fs2#HA#status

An internal error occurred when writing to the cluster database.  
Retry the operation. If the error persists, stop and restart the cluster daemons.

If the problem persists, clear the database, reboot, and re-create the database.

```
Machine 101 machine_sync failed with lock_timeout error
```

The `fs2d` daemon was not able to synchronize the cluster database and the `sync` process timed out. This operation will be retried automatically by `fs2d`.

## ha\_srmd Error Message

The following error is sent by the `ha_srmd` daemon:

```
Executable /var/cluster/ha/resource_types/template/stop does not
have execute file permission
Skipping resource type template configuration because of
configuration errors
Fix the configuration errors and send SIGHUP signal to ha_srmd
process on all nodes in the FailSafe cluster
```

The `stop` action script does not have the correct execution permission and therefore cannot be run. You must change the mode of the script to allow execute permission and then send a `SIGHUP` signal the `ha_srmd` process on each node so that `ha_srmd` will reread the resource type configuration. If `ha_srmd` finds errors in the resource type configuration, errors will be sent to the `SYSLOG` or `ha_srmd` logs. Use the following command line on each node:

```
# killall -HUP ha_srmd
```

## Log File Error Messages

FailSafe maintains logs for each of the FailSafe daemons.

Log file messages take the following form:

```
daemon_log timestamp internal_process: message_text
```

For example:

```
cad_log:Thu Sep 2 17:25:06.092 cclconf_poll_clconfd: clconf_poll failed with error CI_IPCERR_NOPULSE
```

Table C-2 on page 410, shows the parts in the preceding message.

**Table C-2** Log File Error Message Format

Content	Part	Meaning
cad_log	Daemon identifier	The message pertains to the cad daemon
Sep 2 17:25:06.092	Timestamp and process ID	September 2 at 5:25 PM, process ID 92.
cclconf_poll_clconfd	Internal process information	Internal process information
clconf_poll failed with error CI_IPCERR_NOPULSE	Message text	The clconfd daemon could not be contacted to get an update on the cluster's status.

### cad Messages

The following are examples of messages from `/var/cluster/ha/log/cad_log`:

```
ccacdb_cam_open: failed to open connection to CAM
server error 4
```

Internal message that can be ignored because the cad operation is automatically retried.

```
ccamail_cam_open: failed to open connection to CAM
server error 4
```

Internal message that can be ignored because the cad operation is automatically retried.

```
ccicdb_cam_open: failed to open connection to CAM
server error 4
```

Internal message that can be ignored because the cad operation is automatically retried.

```
cclconf_cam_open: failed to open connection to CAM
server error 4
```

Internal message that can be ignored because the cad operation is automatically retried.

```
cclconf_poll_clconfd: clconf_poll failed with error  
CI_IPCERR_NOCONN
```

The clconfd daemon is not running or is not responding to external requests. If the error persists, stop and restart the cluster daemons.

```
cclconf_poll_clconfd: clconf_poll failed with error  
CI_IPCERR_NOPULSE
```

The clconfd daemon could not be contacted to get an update on the cluster's status. If the error persists, stop and restart the cluster daemons.

```
cclconf_poll_clconfd: clconf_poll failed with error  
CI_CLCONFERR_LONELY
```

The clconfd daemon does not have enough information to provide an accurate status of the cluster. It will automatically restart with fresh data and resume its service.

```
csrm_cam_open: failed to open connection to CAM server error 4
```

Internal message that can be ignored because the cad operation is automatically retried.

```
Could not execute notification cmd. system() failed. Error:  
No child processes
```

No mail message was sent because cad could not fork processes. Stop and restart the cluster daemons.

```
error 3 sending event notification to client 0x000000021010f078
```

GUI process exited without cleaning up.

```
error 8 sending event notification to client 0x000000031010f138
```

GUI process exited without cleaning up.

## cli Messages

The following are examples of messages from  
`/var/cluster/ha/log/cli_Hostname:`

```
CI_CONFERR_NOTFOUND, No machines found in the CDB.
```

The local node is not defined in the cluster database.

```
CI_ERR_INVALID, Cluster (bob) not defined
```

The cluster called bob is not present in the cluster database.

```
CI_ERR_INVALID, CLI private command: failed (Cluster (bob) not defined)
```

The cluster called bob is not present in the cluster database.

```
CI_IPCERR_AGAIN, ipccnt_connect(): file  
/var/cluster/ha/comm/clconfd-ipc_fs0 lock failed - Permission  
denied
```

The underlying command line interface (CLI) was invoked by a login other than root. You should only use `cmgr(1M)` when you are logged in as root.

```
CI_IPCERR_NOPULSE, CLI private command: failed (Cluster state  
is UNKNOWN.)
```

The cluster state could not be determined. Check if the `clconfd(1M)` daemon is running.

```
CI_IPCERR_NOPULSE, ipccnt_pulse_internal(): server failed to  
pulse
```

The cluster state could not be determined. Check if the `clconfd(1M)` daemon is running.

```
CI_IPCERR_NOSERVER, clconf ipc: ipccnt_connect() failed, file  
/var/cluster/ha/comm/clconfd-ipc_fs0
```

The local node (`fs0`) is not defined in the cluster database.



```
CI_IPCERR_NOSEVER, Connection file
/var/cluster/ha/comm/clconfd-ipc_fs0 not present.
```

The local node (fs0) is not defined in the cluster database.

## crsd Errors

The following are examples of messages  
from /var/cluster/ha/log/crsd\_*Hostname*:

```
CI_CONFERR_INVALID, Nodeid -1 is invalid.
I_CONFERR_INVALID, Error from ci_security_init().
CI_ERR_SYS:125, bind() failed.
CI_ERR_SYS:125, Initialization failed, exiting.
CI_ERR_NOTFOUND, Nodeid does not have a value.
CI_CONFERR_INVALID, Nodeid -1 is invalid.
```

For each of these messages, either the node ID was not provided in the node definition or the cluster processes were not running in that node when node definition was created in the cluster database. This is a warning that optional information is not available when expected.

```
CI_ERR_NOTFOUND, SystemController information for node fs2 not
found, requests will be ignored.
```

System controller information (optional information) was not provided for node fs2. Provide system controller information for node fs2 by modifying node definition. This is a warning that optional information is not available when expected. Without this information, the node will not be reset if it fails, which might prevent the cluster from properly recovering from the failure.

```
CI_ERR_NOTFOUND, SystemController information for node fs0 not
found, requests will be ignored.
```

The owner node specified in the node definition for the node with a node ID of 101 has not been defined. You must define the owner node.

```
CI_CRSEERR_NOTFOUND, Reset request 0x10087d48 received for node
101, but its owner node does not exist.
```

The owner node specified in the node definition for the node with a node ID of 101 has not been defined. You must define the owner node.

## fs2d Errors

The following are examples of messages from  
`/var/cluster/ha/log/fs2d_Hostname:`

```
Failed to copy global CDB to node fs1 (1), error 4
```

There are communication problems between the local node and node fs2. Check the control networks of the two nodes.

```
Communication failure send new quorum to machine fs2 (102)
(error 6003)
```

There are communication problems between the local node and node fs2. Check the control networks of the two nodes.

```
Failed to copy CDB transaction to node fs2 (1)
```

There are communication problems between the local node and node fs2. Check the control networks of the two nodes.

```
Outgoing RPC to Hostname : NULL
```

If you see this message, check your Remote Procedure Call (RPC) setup. For more information, see the `rpcinfo` and `portmap` man pages.

---

## Glossary

### **action scripts**

The set of scripts that determine how a resource is started, monitored, and stopped. There must be a set of action scripts specified for each resource type. The possible set of action scripts is: `exclusive`, `start`, `stop`, `monitor`, and `restart`.

### **active/backup configuration**

A configuration in which all resource groups have the same primary node. The backup node does not run any highly available resource groups until a failover occurs.

### **administration node**

A node in the pool that is installed with the `cluster_admin.sw.base` software product, allowing the node to perform cluster administration tasks and contain a copy of the cluster database. Within the context of CXFS, there are two types of administration nodes: server-capable administration nodes and client administration nodes.

### **cluster**

A *cluster* is the set of systems (nodes) configured to work together as a single computing resource. A cluster is identified by a simple name and a cluster ID.

There is only one cluster that may be formed from a given pool of nodes.

Disks or logical units (LUNs) are assigned to clusters by recording the name of the cluster on the disk (or LUN). Thus, if any disk is accessible (via a Fibre Channel connection) from machines in multiple clusters, then those clusters must have unique names. When members of a cluster send messages to each other, they identify their cluster via the cluster ID. Thus, if two clusters will be sharing the same network for communications, then they must have unique cluster IDs.

Because of the above restrictions on cluster names and cluster IDs, and because cluster names and cluster IDs cannot be changed once the cluster is created (without deleting the cluster and recreating it), SGI advises that you choose unique names and cluster IDs for each of the clusters within your organization. Clusters that share a network and use XVM must have unique names.

**cluster administration node**

A node in a coexecution cluster that is installed with the `cluster_admin` software product, allowing the node to perform cluster administration tasks and contain a copy of the cluster database. Also known as a *CXFS administration node*.

**cluster administrator**

The person responsible for managing and maintaining a cluster.

**cluster database**

Contains configuration information about all resources, resource types, resource groups, failover policies, nodes, and the cluster.

**cluster database membership**

The group of nodes in the pool that are accessible to `fs2d` and therefore can receive cluster database updates; this may be a subset of the nodes defined in the pool. Also known as *user-space membership* and *fs2d membership*.

**cluster ID**

A unique number within your network in the range 1 through 128. The cluster ID is used by the IRIX kernel to make sure that it does not accept cluster information from any other cluster that may be on the network. The kernel does not use the database for communication, so it requires the cluster ID in order to verify cluster communications. This information in the kernel cannot be changed after it has been initialized; therefore, you must not change a cluster ID after the cluster has been defined.

**cluster node**

A node that is defined as part of the cluster. See also *node*.

**cluster process group**

A group of application instances in a distributed application that cooperate to provide a service.

For example, distributed lock manager instances in each node would form a process group. By forming a process group, they can obtain membership and reliable, ordered, atomic communication services. There is no relationship between a UNIX process group and a cluster process group.

**collector host**

The nodes in the FailSafe cluster itself from which you want to gather statistics, on which Performance Co-Pilot for FailSafe has installed the collector agents.

**control messages**

Messages that cluster software sends between the nodes to request operations on or distribute information about nodes and resource groups. FailSafe sends control messages for the purpose of ensuring that nodes and groups remain highly available. Control messages and heartbeat messages are sent through a node's network interfaces that have been attached to a control network. A node can be attached to multiple control networks.

**control network**

The network that connects nodes through their network interfaces (typically Ethernet) such that FailSafe can maintain a cluster's high availability by sending heartbeat messages and control messages through the network to the attached nodes. FailSafe uses the highest priority network interface on the control network; it uses a network interface with lower priority when all higher-priority network interfaces on the control network fail.

A node must have at least one control network interface for heartbeat messages and one for control messages (both heartbeat and control messages can be configured to use the same interface). A node can have no more than eight control network interfaces.

**CXFS client administration node**

A node that is installed with the `cluster_admin` software product, allowing the node to perform cluster administration tasks and contain a copy of the cluster database, but is not capable of coordinating CXFS metadata. FailSafe can run on a CXFS client-administration node.

**CXFS client-only node**

A node that is installed with the `cxfs_client.sw.base` software product; it does not run cluster administration daemons and is not capable of coordinating cluster activity and metadata. FailSafe cannot run on a client-only node.

**CXFS server-capable administration node**

A node in a coexecution cluster that is installed with the `cluster_admin` product and is also capable of coordinating CXFS metadata. FailSafe can run on a CXFS server-capable administration node.

**database**

See *cluster database*.

**dependency list**

See *resource dependency* or *resource type dependency*.

**failover**

The process of allocating a *resource group* to another *node* according to a *failover policy*. A failover may be triggered by the failure of a resource, a change in the FailSafe membership (such as when a node fails or starts), or a manual request by the administrator.

**failover attribute**

A string that affects the allocation of a resource group in a cluster. The administrator must specify system-defined attributes (such as `Auto_Failback` or `Controlled_Failback`), and can optionally supply site-specific attributes.

**failover domain**

The ordered list of nodes on which a particular *resource group* can be allocated. The nodes listed in the failover domain must be within the same cluster; however, the failover domain does not have to include every node in the cluster. The administrator defines the *initial failover domain* when creating a failover policy. This list is transformed into the *run-time failover domain* by the *failover script*. The run-time failover domain is what is actually used to select the failover node. FailSafe stores the run-time failover domain and uses it as input to the next failover script invocation. The initial and run-time failover domains may be identical, depending upon the contents of the failover script. In general, FailSafe allocates a given resource group to the first node listed in the run-time failover domain that is also in the FailSafe membership; the point at which this allocation takes place is affected by the *failover attributes*.

**failover policy**

The method used by FailSafe to determine the destination node of a failover. A failover policy consists of a *failover domain*, *failover attributes*, and a *failover script*. A failover policy name must be unique within the *pool*.

**failover script**

A failover policy component that generates a *run-time failover domain* and returns it to the FailSafe process. The process applies the failover attributes and then selects the first node in the returned failover domain that is also in the current FailSafe membership.

**FailSafe membership**

The list of FailSafe nodes in a cluster on which FailSafe can make resource groups online. It differs from the CXFS membership. For more information about CXFS, see the *CXFS Administration Guide for SGI InfiniteStorage*.

**FailSafe database**

See *cluster database*.

**heartbeat messages**

Messages that cluster software sends between the nodes that indicate a node is up and running. Heartbeat messages and *control messages* are sent through a node's network interfaces that have been attached to a control network. A node can be attached to multiple control networks.

**heartbeat interval**

Interval between heartbeat messages. The node timeout value must be at least 10 times the heartbeat interval for proper FailSafe operation (otherwise false failovers may be triggered). The higher the number of heartbeats (smaller heartbeat interval), the greater the potential for slowing down the network. Conversely, the fewer the number of heartbeats (larger heartbeat interval), the greater the potential for reducing availability of resources.

**initial failover domain**

The ordered list of nodes, defined by the administrator when a failover policy is first created, that is used the first time a cluster is booted. The ordered list specified by the

initial failover domain is transformed into a *run-time failover domain* by the *failover script*; the run-time failover domain is used along with failover attributes to determine the node on which a resource group should reside. With each failure, the failover script takes the current run-time failover domain and potentially modifies it; the initial failover domain is never used again. Depending on the run-time conditions and contents of the failover script, the initial and run-time failover domains may be identical. See also *run-time failover domain*.

**key/value attribute**

A set of information that must be defined for a particular resource type. For example, for the resource type `filesystem` one key/value pair might be `mount_point=/fs1` where `mount_point` is the key and `fs1` is the value specific to the particular resource being defined. Depending on the value, you specify either a `string` or `integer` data type. In the previous example, you would specify `string` as the data type for the value `fs1`.

**log configuration**

A log configuration has two parts: a *log level* and a *log file*, both associated with a *log group*. The cluster administrator can customize the location and amount of log output, and can specify a log configuration for all nodes or for only one node. For example, the `crsd` log group can be configured to log detailed level-10 messages to the `/var/cluster/ha/log/crsd-foo` log only on the node `foo` and to write only minimal level-1 messages to the `crsd` log on all other nodes.

**log file**

A file containing notifications for a particular *log group*. A log file is part of the *log configuration* for a log group. By default, log files reside in the `/var/cluster/ha/log` directory, but the cluster administrator can customize this. Note: FailSafe logs both normal operations and critical errors to `/var/adm/SYSLOG`, as well as to individual logs for specific log groups.

**log group**

A set of one or more FailSafe processes that use the same log configuration. A log group usually corresponds to one daemon, such as `gcd`.



**log level**

A number controlling the number of log messages that FailSafe will write into an associated log group's log file. A log level is part of the log configuration for a log group.

**LUN**

Logical unit number

**monitor host**

A workstation that has a display and is running the IRIS Desktop, on which Performance Co-Pilot for FailSafe has installed the monitor client.

**node**

A *node* is an operating system (OS) image, usually an individual computer. (This use of the term *node* does not have the same meaning as a node in an SGI Origin 3000 or SGI 2000 system.)

A given node can be a member of only one pool (and therefore) only one cluster.

**node ID**

A 16-bit positive integer that uniquely defines a node. During node definition, FailSafe will assign a node ID if one has not been assigned by the cluster administrator. Once assigned, the node ID cannot be modified.

**node timeout**

If no heartbeat is received from a node in this period of time, the node is considered to be dead. The node timeout value must be at least 10 times the heartbeat interval for proper FailSafe operation (otherwise false failovers may be triggered).

**notification command**

The command used to notify the cluster administrator of changes or failures in the cluster, nodes, and resource groups. The command must exist on every node in the cluster.

**offline resource group**

A resource group that is not highly available in the cluster. To put a resource group in offline state, FailSafe stops the group (if needed) and stops monitoring the group. An offline resource group can be running on a node, yet not under FailSafe control. If the cluster administrator specifies the *detach only* option while taking the group offline, then FailSafe will not stop the group but will stop monitoring the group.

**online resource group**

A resource group that is highly available in the cluster. When FailSafe detects a failure that degrades the resource group availability, it moves the resource group to another node in the cluster. To put a resource group in online state, FailSafe starts the group (if needed) and begins monitoring the group. If the cluster administrator specifies the *attach only* option while bringing the group online, then FailSafe will not start the group but will begin monitoring the group.

**owner host**

A system that can control a node remotely, such as power-cycling the node. At run time, the owner host must be defined as a node in the pool.

**owner TTY name**

The device file name of the terminal port (TTY) on the *owner host* to which the system controller serial cable is connected. The other end of the cable connects to the node with the system controller port, so the node can be controlled remotely by the owner host.

**plug-in**

The set of software required to make an application highly available, including a resource type and action scripts. There are plug-ins provided with the base FailSafe release, optional plug-ins available for purchase from SGI, and customized plug-ins you can write using the instructions in the *FailSafe Programmer's Guide for SGI Infinite Storage*.

**pool**

The *pool* is the set of nodes from which a particular cluster may be formed. Only one cluster may be configured from a given pool, and it need not contain all of the available nodes. (Other pools may exist, but each is disjoint from the other. They share no node or cluster definitions.)

A pool is formed when you connect to a given node and define that node in the cluster database using the CXFS GUI or `cmgr` command. You can then add other nodes to the pool by defining them while still connected to the first node, or to any other node that is already in the pool. (If you were to connect to another node and then define it, you would be creating a second pool).

**port password**

The password for the system controller port, usually set once in firmware or by setting jumper wires. (This is not the same as the node's `root` password.)

**powerfail mode**

When powerfail mode is turned on, FailSafe tracks the response from a node's system controller as it makes reset requests to a node. When these requests fail to reset the node successfully, FailSafe uses heuristics to try to estimate whether the machine has been powered down. If the heuristic algorithm returns with success, FailSafe assumes the remote machine has been reset successfully. When powerfail mode is turned `off`, the heuristics are not used and FailSafe may not be able to detect node power failures.

**process membership**

A list of process instances in a cluster that form a process group. There can be multiple process groups per node.

**re-MACing**

The process of moving the physical medium access control (MAC) address of a network interface to another interface. It is done by using the `macconfig` command.

**resource**

A single physical or logical entity that provides a service to clients or other resources. For example, a resource can be a single disk volume, a particular network address, or an application such as a web server. A resource is generally available for use over time on two or more nodes in a cluster, although it can be allocated to only one node at any given time. Resources are identified by a resource name and a resource type. Dependent resources must be part of the same resource group and are identified in a resource dependency list.

**resource dependency**

The condition in which a resource requires the existence of other resources.

**resource dependency list**

A list of resources upon which a resource depends. Each resource instance must have resource dependencies that satisfy its resource type dependencies before it can be added to a resource group.

**resource group**

A collection of resources. A resource group is identified by a simple name; this name must be unique within a cluster. Resource groups cannot overlap; that is, two resource groups cannot contain the same resource. All interdependent resources must be part of the same resource group. If any individual resource in a resource group becomes unavailable for its intended use, then the entire resource group is considered unavailable. Therefore, a resource group is the unit of failover.

**resource keys**

Variables that define a resource of a given resource type. The action scripts use this information to start, stop, and monitor a resource of this resource type.

**resource name**

The simple name that identifies a specific instance of a resource type. A resource name must be unique within a given resource type.

**resource type**

A particular class of resource. All of the resources in a particular resource type can be handled in the same way for the purposes of failover. Every resource is an instance of exactly one resource type. A resource type is identified by a simple name; this name must be unique within a cluster. A resource type can be defined for a specific node or for an entire cluster. A resource type that is defined for a node overrides a cluster-wide resource type definition with the same name; this allows an individual node to override global settings from a cluster-wide resource type definition.

**resource type dependency**

A set of resource types upon which a resource type depends. For example, the `filesystem` resource type depends upon the `volume` resource type, and the `Netscape_web` resource type depends upon the `filesystem` and `IP_address` resource types.

**resource type dependency list**

A list of resource types upon which a resource type depends.

**run-time failover domain**

The ordered set of nodes on which the resource group can execute upon failures, as modified by the failover script. The run-time failover domain is used along with failover attributes to determine the node on which a resource group should reside. See also *initial failover domain*.

**server-capable administration node**

See *CXFS server-capable administration node*

**start/stop order**

Each resource type has a start/stop order, which is a nonnegative integer. In a resource group, the start/stop orders of the resource types determine the order in which the resources will be started when FailSafe brings the group online and will be stopped when FailSafe takes the group offline. The group's resources are started in increasing order, and stopped in decreasing order; resources of the same type are started and stopped in indeterminate order. For example, if resource type `volume` has order 10 and resource type `filesystem` has order 20, then when FailSafe brings a resource group online, all volume resources in the group will be started before all file system resources in the group.

**storage area network (SAN)**

A dedicated, high-speed, scalable network of servers and storage devices designed to enhance the storage, retrieval, and management of data

**system controller port**

A port located on a node that provides a way to power-cycle the node remotely. Enabling or disabling a system controller port in the cluster database (CDB) tells FailSafe whether it can perform operations on the system controller port. (When the port is enabled, serial cables must attach the port to another node, the owner host.) System controller port information is optional for a node in the pool, but is required if the node will be added to a cluster; otherwise resources running on that node never will be highly available.

**tiebreaker node**

A node identified as a tiebreaker for FailSafe to use in the process of computing the FailSafe membership for the cluster, when exactly half the nodes in the cluster are up and can communicate with each other. If a tiebreaker node is not specified, FailSafe will use the node with the lowest node ID in the cluster as the tiebreaker node.

**type-specific attribute**

Required information used to define a resource of a particular resource type. For example, for a resource of type `filesystem` you must enter attributes for the resource's volume name (where the file system is located) and specify options for how to mount the file system (for example, as readable and writable).

---

## Index

### A

- action script timeouts, modifying, 204
- action scripts, 15
- activate FailSafe, 240
- ACTIVE cluster status, 299
- active/backup configuration, 36
- add nic, 158
- add/remove
  - dependencies for a resource definition, 218
  - dependencies for a resource type, 198
  - nodes in the cluster, 164
- administration node, 49
- administration of FailSafe, 23
- aliasing IP addresses, 24
- alternate path failover, 355
- application failover domain, 14
- application monitoring, 22
- ATM LAN emulation failover, 18
- attributes for failover, 15
- Auto\_Failback failover attribute, 15, 225
- Auto\_Recovery failover attribute, 225
- AutoLoad boot parameter, 91, 98

### B

- blue text, 123
- broadcast address, 211

### C

- cad
  - messages, 410
  - process, 142, 366
  - verify it is running, 366

- CAD options file, 93
- can't run remotely, 91, 350
- CD contents, 387
- cdb-exitop, 350
- cdbreinit command, 368
- chkconfig, 103, 142
- clconfd process, 142
- CLI
  - See "cmgr", 129
- cli
  - errors, 405
  - log, 247
  - messages, 412
- client administration node, 159
- client-only node, 49
- cluster
  - convert, 181
  - define, 175
  - delete, 182
  - display, 184
  - environment, 4
  - error recovery, 358
  - membership, 7
  - modify, 179
  - process group, 16
  - status, 299
  - tasks, 174
  - terminology, 5
  - type, 49
- cluster database
  - backup/restore, 81, 325
  - maintenance, 365
  - membership, 7
  - recovery, 365, 367
  - security, 222
  - sync failure, 365
  - terminology, 6

- Cluster Manager GUI
  - See "GUI", 117
- cluster\_mgr command, 128
- cluster\_status, 298
- cmgr, 23
  - c option, 133
  - command line execution, 133
  - exiting, 131
  - help, 129
  - invoking a shell, 139
  - overview, 128
  - p option, 129
  - prompt mode, 129
  - scripts and, 133
  - See cmgr, 129
  - startup script, 132
  - template files, 138
- cmgr-templates directory, 138
- CMGR\_STARTUP\_FILE environment variable, 132
- cmond
  - errors, 407
  - process, 142, 366
  - verify it is running, 366
- cmond.options file, 97
- collector host installation, 110
- command-line editing in cmgr, 131
- concepts, 5
- configuration overview, 29
- configuration parameters
  - filesystem, 45
  - IP address, 56
  - local XVM volumes, 40
  - XLV logical volumes, 39
- configuration planning
  - disk, 32
  - example, 31
  - filesystem, 42
  - IP address, 53
  - logical volume, 38
- configuration tasks
  - add/remove
    - dependencies for a resource definition, 218
    - dependencies for a resource type, 198
    - nodes in the cluster, 164
    - resources in resource group, 237
- cluster definition, 175
- cluster tasks, 174
- connectivity test, 337
- convert
  - CXFS cluster, 181
  - CXFS node to FailSafe, 169
- custom
  - failure detection, 152
  - resource failover behavior, 153
  - resource group failover behavior, 152
- defaults in cmgr, 145
- define
  - custom resource, 151
  - failover policy, 223
  - node, 154
  - resource, 208
  - resource group, 234
  - resource type, 185
- delete
  - cluster, 182
  - failover policy, 232
  - node, 171
  - resource, 221
  - resource group, 237
  - resource type, 206
- display
  - cluster, 184
  - failover policy, 233
  - node, 173
  - resource, 222
  - resource group, 238
  - resource type, 207
- failover policy, 223
- fix or upgrade cluster nodes, 150
- guided configuration, 146
- HA services tasks, 239
- load a resource type, 201
- log groups, 250



- make changes to existing cluster, 150
  - modify
    - cluster definition, 179
    - failover policy definition, 229
    - node definition, 164
    - resource definition, 220
    - resource group definition, 236
    - resource type, 201
  - monitoring intervals, 144
  - mount a filesystem, 180
  - name restrictions, 144
  - node
    - addition to cluster, 164
    - deletion, 171
    - resets, 323
    - tasks, 154
  - notify administrator of cluster changes, 175
  - optimize node usage, 151
  - preliminary steps, 141
  - redefine
    - resource for a specific node, 216
    - resource type for a specific node, 194
  - resource group tasks, 234
  - resource load redistribution, 153
  - resource tasks, 207
  - resource type
    - tasks, 185
  - set FailSafe HA parameters, 244
  - set log configuration, 246
  - set up
    - existing CXFS cluster for FailSafe, 149
    - HA resource group, 148
    - new cluster, 147
  - start
    - HA services, 240
    - stop HA services, 241
    - timeout values, 144
  - connectivity test, 337
  - control network, 9, 18, 155
    - changing in cluster, 375
    - recovery, 364
  - Controlled\_Failback failover attribute, 15, 225
  - controllers, 19
  - conversion between CXFS and FailSafe, 53
  - convert
    - FailSafe cluster, 149, 181
    - FailSafe node, 149, 169
    - FailSafe task, 149
  - corepluspid system parameter, 98
  - create a cluster, 175
  - Critical\_RG failover attribute, 226
  - crsd
    - errors, 406, 413
    - log, 247
    - process, 142, 366
    - verify it is running, 366
  - custom
    - failover scripts, 15
    - failure detection, 152
    - resource, 151
    - resource failover behavior, 153
    - resource group failover behavior, 152
  - CXFS
    - configuration example, 276
    - exporting filesystems, 277
    - FailSafe and, 276
    - GUI, 52
    - membership, 7
    - metadata servers and failover domain, 50
    - node types, 49
    - resource type for FailSafe, 50
  - CXFS interaction, 23
- ## D
- daemons, 142, 366
  - database membership
    - See "cluster database membership", 7
  - deactivate FailSafe HA services, 241, 322
  - defaults, 145
  - define
    - cluster, 175

- custom resource, 151
- failover policy, 223
- node, 154
- resource, 208
- resource group, 234
- resource type, 185
- delete
  - cluster, 182
  - failover policy, 232
  - node, 171
  - resource, 221
  - resource group, 237
  - resource type, 206
- dependency list, 12
- deskside storage systems, 18
- destructive mode, 342
- details area, 121
- detect failures, 152
- developer's guide, 15
- devname-group
  - XLV, 39
- devname-mode
  - XLV, 39
- devname-owner
  - XLV, 39
- devname\_group
  - local XVM, 40
- devname\_mode
  - local XVM, 40
- devname\_owner
  - local XVM, 40
- diags log, 247
- DISCOVERY state, 305
- disk
  - configuration planning, 32
  - connections, 19
  - storage, 18
  - storage types, 26
- display
  - cluster, 184
  - failover policy, 233
  - nodes, 173

- resource, 222
- resource group, 238
- resource type, 207
- DNS, 70
- dns, 70
- domain, 14, 227
- domain name service , 70
- DOWN node state, 307
- driver subsystems, 388
- dual controllers, 19
- dual hubs, 19
- dual pathing, 19
- dual vaults, 19
- dynamic management, 22

## E

- Edit menu, 122
- EL-16, 18
- emulation failover, 18
- ERROR cluster status, 299
- error state, resource group, 305
- ESP, 80, 314
  - /etc/config/cad.options file, 93
  - /etc/config/cmond.options file, 97
  - /etc/config/fs2d.options file, 94
  - /etc/config/netif.options, 70
  - /etc/config/routed.options, 102
  - /etc/failover.conf, 356
  - /etc/fstab, 43, 45
  - /etc/hosts file, 54
  - /etc/inetd.conf, 366
  - /etc/inittab, 105
  - /etc/nsswitch.conf, 70, 104
  - /etc/services file, 93
- Etherlite multiplexer driver subsystems, 388
- Ethernet, 18
- examples
  - add
    - node, 373

- resource groups or resources in an active cluster, 379
- add/remove
  - dependencies for a resource type, 200
- attributes, 188
- bring a resource group online, 317
- change the log level, 251
- chkconfig, 103
- cluster information display, 133
- cluster\_status, 298
- commands used to create NFS, CXFS and statd\_unlimited resources, 51
- configuration planning process, 31
- configuration types, 20
- configuration with four resource groups, 32
- configuration with two resource groups, 34
- configure network interfaces, 100
- convert
  - cluster, 182
  - node, 170
- create a resource group, 278
- define
  - a cluster, 178
  - a resource, 213
  - a resource group, 235
  - failover policy, 229
  - log group, 250
  - node, 162
  - resource type, 190
- delete
  - cluster, 182
  - node, 172, 374
  - resource group, 237
- dependencies, 13
- dependencies for a resource type, 199
- detach a resource group, 358, 374
- determine hostname, 143
- display
  - cluster, 184
  - resource group, 239
- /etc/config/cad.options, 94
- /etc/config/fs2d.options, 96
- /etc/config/routed.options, 102
- /etc/hosts contents and hostname resolution, 70
- /etc/inittab, 105
- /etc/nsswitch.conf, 70, 104
- /etc/services, 93, 372
- export CXFS filesystems, 277
- failover domain, 228
- FailSafe configuration, 270
- FailSafe Manager GUI, 126
- FailSafe membership, 8, 9
- failure of a resource's monitor action, 187
- filesystem configuration, 45
- filesystems and logical volumes, 46
- GUI showing details for a resource, 126
- HA IP address configuration, 56
- haStatus, 308
- heartbeat response statistics, 382
- heterogeneous clusters for an IP\_address resource, 216
- increase the statd\_unlimited resource type monitor executable timeout, 204
- interface configuration, 100
- log file
  - management, 82, 329
  - name, 248
- logging information and
  - /etc/config/fs2d.options, 96
- logical volume configuration, 39
- modify
  - cluster, 172
  - cluster to include a CXFS filesystem, 276
  - node, 170
  - resource group, 236
  - resource type timeouts, 205
- monitoring system status, 298
- move a resource group, 320, 361, 378
- mutual dependency of resources is not allowed, 219
- name of a filesystem resource, 209
- network reset model, 20
- nodes in the failover domain, 227

- non-shared disk configuration and failover, 34
- offline a resource group, 361
- offline detach, 296
- output when just the initial daemons are running, 143
- partition ID determination, 156
- partitioning, 167
- patch installation, 105
- Performance Co-Pilot, 382
- pool and cluster concepts, 5
- prompt mode, 129
- redefine resource for a specific node, 216
- remove the error state of a resource, 364
- reset models, 20
- resource
  - defining, 209
  - dependency, 218
  - monitoring statistics, 383
- resource group, 11
  - maintenance and error recovery, 360
  - recovery, 359
- resource type dependencies, 13
- .rhosts, 116
- ring configuration, 20
- script files, 134
- script to define a three-node cluster, 270
- server-to-server reset model, 20
- set group ID, 214
- setting configuration defaults for cmgr, 145
- sgi-cad, 93
- sgi-cmsd, 93
- sgi-crsd, 93
- sgi-gcd, 93
- shared disk configuration
  - active/backup use, 36
  - dual-active use, 37
- show
  - cluster, 171
  - failover policy, 293
  - nodes in pool/cluster, 174
- single node, 293
- star configuration, 20

- start
  - cluster daemons, 142
  - HA services, 241, 373, 377
  - HA services on a subset of nodes, 240
- startup script, 132
- stop HA services, 244, 360, 374
- system components, 17
- test
  - a resource, 340
  - failover policy, 344
  - logical volumes, 341
  - multiple nodes, 338
  - network connectivity, 339
  - private network interface, 113
  - resource type, 341
  - serial connections, 338
  - serial reset connection, 114
- three-node cluster, 269
- two-node
  - cluster, 22
  - configuration, 20
  - resuming use of, 295
- upgrades
  - software in an active cluster, 378
  - /usr/lib/aliases, 104
  - verify cluster daemons are running, 366
  - verify that chkconfig flags are on, 142
  - XLV naming scheme, 43
- exclusive action script, 15

## F

- failover, 14
  - and recovery processes, 28
  - behavior of a resource, 153
  - behavior of a resource group, 152
  - description, 28
  - resource group, 315
- failover attributes, 15, 224, 230
- failover domain, 14, 227

failover of NLBS virtual network interfaces, 26

failover policy, 14

- define, 223
- delete, 232
- display, 233
- failover attributes, 224, 230
- failover domain, 227
- failover script, 230
- modification, 229
- modify, 229
- tasks, 223
- test, 338, 344

failover script, 15, 230

failover.conf, 356

FailSafe Manager

- See "GUI", 120

FailSafe membership, 7, 352

failure detection, 152

fake\_owner, 41

FDDI, 18

features, 22

Fibre Channel, 18

Fibre Channel RAID storage, 26, 42

File menu, 72, 120, 121

filesystem

- configuration parameters, 45
- configuration planning, 42
- mounting, 180
- resource, 209
- test, 342

Find text field, 123

fine-grain failover, 23

fix cluster nodes, 150

FORE Systems ATM cards and switch, 18

fs2d

- errors, 408, 414
- options file, 94
- process, 142, 366
- verify it is running, 366

fs2d membership

- See "cluster database membership", 7

fs\_xvm\_owner, 41

fsafe.srm\* metrics, 393

fsdetail (fsmgr), 72

fsmgr, 72

fstask (fsmgr), 72

function of a node, 159

## G

### GUI

- multiple instances, 72, 120
- overview, 117
- problems, 366
- recovery, 367
- See "configuration tasks", 147
- starting, 119

guided configuration tasks, 121

## H

### HA parameters

- set, 244

### HA services

- start, 240

- stop, 241

### HA services tasks, 239

ha\_agent log, 247

ha\_cmsd log, 247

ha\_fsd log, 247

ha\_fsd process, 15

ha\_gcd log, 247

ha\_ifd log, 247

ha\_script log, 247

ha\_srmd

- errors, 409

ha\_srmd log, 247

hardware components, 17

hardware device, adding to cluster, 380

haStatus script, 308

heartbeat interval, 244

- heartbeat network, 9, 18, 155
- help
  - for cmgr, 129
  - for GUI, 147
- help menu, 123
- history command in cmgr, 131
- hostname
  - control network, 155
  - determination, 143
- hubs, 19

## I

- icons and states, 300
- ifconfig, 340
- INACTIVE
  - cluster status, 299
  - node state, 307
- initial cluster configuration, 146
- initial failover domain, 14, 227, 231
- INITIALIZING state, 305
- inittab file, 104
- InPlace\_Recovery failover attribute, 225
- input instructions, 125
- install resource type, 201
- installation, 87
- installing patches, 105
- INTERNAL ERROR state, 304, 305
- IP address
  - aliasing, 24
  - configuration planning, 53
  - control network and, 155
  - fixed, 24
  - highly available, 25
  - overview, 24
  - planning, 53, 61
  - resource, 210
- is\_\* commands, 158
- item view
  - See "details view", 121

## J

- Java Plug-in, 388
- java\_plugin, 90
- JBOD, 18, 19, 26

## L

- L1, 160
- L2, 160
- LAN emulation failover, 18
- load a resource type, 201
- load redistribution, 153
- local restart, 23
- local XVM volumes
  - resource attributes, 40
- log configuration, 246
- log files, 248, 351
  - errors, 409
  - management, 82, 329
- log levels, 247
- log messages
  - debug, 352
  - error, 352
  - normal, 351
  - syslog, 352
  - warning, 352
- logical volume
  - configuration planning, 38
  - creation, 98
  - parameters, 39
  - testing, 341
- lonely state, 79
- long-running tasks, 132

## M

- MAC address
  - impersonation, 25

- MAC address resource, 211
- maintenance mode, 321
- make changes to an existing cluster, 150
- managed resources, 22
- membership, 7, 352–354
- metadata server-capable administration node, 49
- metrics exported by Performance Co-Pilot, 393
- miniroot installation, 350
- miniroot installation and error messages, 91
- mirror disks, 26
- mirrored disks, 20, 42
- mkpart, 156, 160
- MMSC, 160
- mode, 45
- modify
  - cluster, 150
  - failover policy definition, 229
  - node, 164
  - resource definition, 220
  - resource group definition, 236
- modify a resource type, 201
- monitor
  - action script, 15
  - applications, 22
  - host, 112
  - license, 112
  - system status, 298
- MONITOR ACTIVITY UNKNOWN error state, 305
- monitor-level, 45
- monitoring interval, 144
- MSC, 160
- multihosted RAID disks devices, 20
- multiplexer driver subsystems, 388

## N

- name restrictions, 69, 144
- name service daemon, 70
- netif.options, 70, 102
- Netscape
  - servers, testing with cmgr, 343

- network connectivity, 337, 339
- network information service, 70
- network interface
  - configuration, 100
  - overview, 24
- network load balancing software and FailSafe, 26
- network mask, 210
- network reset model, 21
- network segment, 9
- networks, 9
- NFS and CXFS filesystems, 277
- NIS, 70
- NIS database, 101
- NLBS and FailSafe, 26
- NMI a node, 324
- NO AVAILABLE NODES error state, 305
- NO ERROR error state, 305
- NO MORE NODES IN AFD error message, 362
- node
  - add/remove, 164
  - adding to cluster, 371
  - configuration, 87
  - convert, 169
  - define, 154
  - delete, 171
  - deleting from cluster, 373
  - display, 173
  - error recovery, 359
  - function, 159
  - highly available, 24
  - modify, 164
  - reset, 322, 353
  - resets, 322
  - state, 307
  - status, 307
  - tasks, 154
  - term defined, 5
  - timeout, 244
  - type, 50
  - usage optimization, 151
  - wait time, 244

- NODE NOT AVAILABLE error state, 305
- NODE UNKNOWN error state, 305
- node-specific resource, 216
- node-specific resource type, 194
- Node\_Failures\_Only failover attribute, 226
- notification, 179
- notify administrator of cluster changes, 175
- nsadmin, 70
- nsswitch.conf, 70
- NVRAM variables, 98

## O

- OFFLINE state, 304
- OFFLINE-PENDING state, 304
- ONLINE state, 304
- ONLINE-MAINTENANCE state, 304, 321
- ONLINE-PENDING state, 304
- ONLINE-READY state, 304, 316
- operating system process group, 16
- optimize node usage, 151
- ordered failover script, 15
- overlap of resource groups, 12
- overview of FailSafe, 1

## P

- partition, 160, 165
- partition ID , 156
- patch installation, 105
- pathing, 19
- pcp\_eoe.sw, 110, 112
- PCPMON, 112
- perform tasks, 124
- Performance Co-Pilot
  - installation, 109
  - metrics, 393
- performance metrics, 112
- Performance Metrics Domain Agent (PMDA), 111
- physvol\_names, 41

- pinging system controller, 307
- plexed disks, 20
- plexing, 26, 42
- plug-in
  - terminology, 16
- PMDA, 111
- pool, 5
- power cycle a node, 323
- powerfail mode, 245
- preliminary configuration steps, 141
- primary node, 36, 60
- private network
  - interface, 113
  - use of, 9
- Privilege Manager, 119
- privilege tasks, 331
- process group, 16
- programmer's guide, 15

## Q

- quorum, 7

## R

- rackmount storage systems, 18
- RAID storage, 18, 19, 26, 42
- re-MACing, 25
  - dedicated backup interfaces required, 54
  - determining if required, 55
- recovery
  - overview, 345
  - procedures, 357
- redefine
  - resource for a specific node, 216
  - resource type for a specific node, 194
- redistribute resource load, 153
- redundancy, 20
- remote installation and error messages, 91



- Remote System Control port, 18
- remove
  - dependencies for a resource definition, 218
  - dependencies for a resource type, 198
  - nic, 158
  - node from the pool, 171
  - nodes, 179
- remove resources in resource group, 237
- reset
  - connection test, 114
  - hardware, 18
  - models, 20, 21
  - nodes, 322, 353
- reset method, 157
- resource
  - adding to cluster, 379
  - define, 208
  - delete, 221
  - dependencies, 218
  - dependency list, 12
  - display, 222
  - failover behavior, 153
  - filesystem, 209
  - in resource group, 237
  - IP address, 210
  - MAC address, 211
  - modify, 220
  - name, 11
  - NFS, 278
  - node-specific, 216
  - overview, 24
  - owner, 306
  - recovery, 363
  - statd\_unlimited, 213
  - status, 302
  - terminology, 10, 24
  - volume, 211
  - XVM, 212
- resource attributes
  - local XVM volumes, 40
  - XLV logical volumes, 39
- resource group
  - add/remove
    - resources, 237
  - adding to cluster, 379
  - bringing online, 315
  - creation example, 278
  - define, 234
  - delete, 237
  - dependencies, 237
  - detaching, 317
  - display, 238
  - error state, 305
  - failover, 315
  - failover behavior, 152
  - forcing offline, 317
  - modify, 236
  - monitoring, 321
  - moving, 319
  - recovery, 360
  - resume monitoring, 322
  - state, 304
  - status, 302
  - suspend monitoring, 321
  - taking offline, 315, 317
  - terminology, 11
  - test, 343
- resource group tasks, 148, 234
- resource load redistribution, 153
- resource tasks, 207
- resource type
  - define, 185
  - delete, 206
  - dependencies, 198
  - dependency list, 12
  - display, 207
  - load, 201
  - modify, 201
  - NFS, 278
  - node-specific, 194
  - terminology, 11
- resource type tasks, 185
- restart (local), 23

- restart action script, 15
- revoke privileges to access tasks, 335
- /.rhosts file, 116
- ring configuration, 20
- ring reset, 104
- rotatelog, 329
- rotating log files, 82, 329
- round-robin failover script, 15
- rsh, 116
- run-time failover domain, 14, 227, 231

## S

- scripts and cmgr, 133
- SCSI
  - bus, 18
  - ID parameter, 98
  - storage, 26
- security of the cluster database, 222
- selecting items to view or modify, 123, 331, 335
- serial connections, 338
- serial hardware reset connections, 18, 114
  - cable recovery, 364
  - cables, 49
  - diagnostic tests, 337
  - port configuration, 104
- server-capable administration node, 49, 159
- server-to-server reset model, 21
- set commands, 158
- set FailSafe HA parameters, 244
- set log configuration, 246
- set up new cluster, 147
- SGI 200, 17
- SGI 2000, 17
- SGI Origin 3000, 17
- sgi-cad, 93
- sgi-cmsd, 93
- sgi-crsd, 93
- sgi-gcd, 93
- shared disk issues, 42
- show
  - cluster, 184
  - node, 173
  - resource type, 207
- single controller, 19
- single hub, 19
- single pathing, 19
- single vault, 19
- single-node use, 293
- software overview, 387
- SPLIT RESOURCE GROUP (EXCLUSIVITY)
  - error state, 305, 362
- SRMD EXECUTABLE ERROR error state, 305
- star configuration, 19
- start
  - cluster daemons, 142
  - HA services, 240
- start action script, 15
- startup script for cmgr, 132
- statd\_unlimited resource, 213
- state, resource group, 304
- states and icons, 300
- status
  - cluster, 299
  - node, 307
  - resource, 302
  - resource group, 303
  - system controller, 303
  - system, overview, 80, 297
- stop action script, 15
- stop HA services, 241, 322
  - force option, 242
- storage connection, 18
- subsystems on the CD, 387
- sysadmdesktop, 119
- sysctrl\* commands, 158
- SYSLOG, 121
  - error messages, 403
  - events logged to, 96
- SYSLOG error messages, 352
- system configuration defaults, 145
- system controller

- status, 303
- types, 160
- system files, 92
- system log file, 121
- system status, 80, 297

## T

- task access privileges, 331
- tasks, 124
  - See "configuration tasks", 141
- Tasks menu, 122
- tcpmux, 366
- tcpmux/sgi\_sysadm, 366
- template files, 138
- term definitions, 125
- terminology, 5
- testing, 113
- three-node cluster, example, 269
- tiebreaker node, 245, 353
- timeout values, 144
- timeouts, action script, 204
- Toolchest, 118
- TP9100, 18
- TP9400, 18
- TP9900, 18
- tree view
  - See "view area", 121
- troubleshooting
  - cad messages, 410
  - cli errors, 405
  - cli messages, 412
  - cmond errors, 407
  - crsd errors, 406, 413
  - fs2d errors, 408, 414
  - GUI will not run, 366
  - ha\_srmd errors, 409
  - log file errors, 409
  - SYSLOG errors, 403
  - tools, 65
- two-node

- clusters and single-node use, 293
- configuration, 22
- resuming use of the cluster, 295

## U

- Unified Name Service, 70
- UNKNOWN
  - cluster status, 299, 358
  - node state, 307
- UNS, 70
- UP node state, 307
- upgrade cluster nodes, 150
- upgrade FailSafe, 22
- upgrading
  - FailSafe software, 378
  - OS software, 377
- user privileges, 222
- user-space membership
  - See "cluster database membership", 7
  - /usr/etc/ifconfig, 114, 340
  - /usr/lib/aliases, 104

## V

- /var/adm/SYSLOG, 96, 121
- /var/cluster/cmgr-scripts/rotatlogs, 329
- /var/pcp/pmdas/fsafe, 111
- vaults, 19
- verify cluster daemons are running, 366
- view area, 121
- view cluster components, 123
- view component details, 124
- virtual network interfaces (for NLBS) and
  - FailSafe, 26
- volume
  - resource, 211
  - test, 341
- volume-name, 45

**W**

workstation subsystem software, 390  
wsync mode, and NFS filesystems, 43

**X**

XFS

filesystem creation, 98

XLV

logical volume creation, 98

parameters, 39

plexing, 26, 42

XVM

alternate path failover, 355

resource, 212

resource attributes, 40

**Y**

ypmatch, 101