



SGI® OpenGL Multipipe™ SDK User's Guide

Version 3.0

007-4239-003



CONTRIBUTORS

Written by Ken Jones

Illustrated by Chrystie Danzer and Jenn Byrnes

Edited by Susan Wilkening

Production by Glen Traefald

Engineering contributions by Patrick Bouchaud, Davy Courvoisier, Stefan Eilemann, and Philippe Robert

COPYRIGHT

© 2002, 2003 Silicon Graphics, Inc. All rights reserved; provided portions may be copyright in third parties, as indicated elsewhere herein. No permission is granted to copy, distribute, or create derivative works from the contents of this electronic documentation in any manner, in whole or in part, without the prior written permission of Silicon Graphics, Inc.

LIMITED RIGHTS LEGEND

The electronic (software) version of this document was developed at private expense; if acquired under an agreement with the USA government or any contractor thereto, it is acquired as "commercial computer software" subject to the provisions of its applicable license agreement, as specified in (a) 48 CFR 12.212 of the FAR; or, if acquired for Department of Defense units, (b) 48 CFR 227-7202 of the DoD FAR Supplement; or sections succeeding thereto. Contractor/manufacturer is Silicon Graphics, Inc., 1600 Amphitheatre Pkwy 2E, Mountain View, CA 94043-1351.

TRADEMARKS AND ATTRIBUTIONS

Silicon Graphics, SGI, the SGI logo, IRIX, InfiniteReality, OpenGL, Onyx, Onyx2, and Reality Center are registered trademarks and GLX, InfinitePerformance, Open Inventor, the OpenGL logo, OpenGL Multipipe, OpenGL Performer, OpenGL Volumizer, and VPro are trademarks of Silicon Graphics, Inc., in the United States and/or other countries worldwide.

DaimlerChrysler is a registered trademark of DaimlerChrysler AG Corporation. HOLOBENCH and TANORAMA are registered trademarks of Helmut Tan. Responsive Workbench is a registered trademark of GMD. V-Dome is a trademark of SEOS Limited. The X device is a registered trademark and Xinerama is a trademark of The Open Group in the United States and other countries.

New Features in This Release

OpenGL Multipipe SDK 3.0 includes the following features:

- New, extensive support for culling
- Enhanced support for adaptive screen-based decomposition
- Enhanced interoperability with the SGI OpenGL Multipipe product
- Enhanced support for the SGI Scalable Graphics Compositor
- Support for the SGI Onyx next-generation scalable graphics platform
- Automatic processor assignment for window threads
- A reference manual, *SGI OpenGL Multipipe SDK Reference Pages*

Record of Revision

Version	Description
001	May 2002 Original publication. Supports the 2.0 release of OpenGL Multipipe SDK.
002	October 2002 Updated to support the 2.1 release of OpenGL Multipipe SDK.
003	June 2003 Updated to support the 3.0 release of OpenGL Multipipe SDK.

Contents

Figures	xi
Tables	xiii
About This Guide.	xv
Audience	xv
What This Guide Contains	xv
Related Publications	xvi
Obtaining Publications	xvi
Conventions	xvi
Reader Comments.	xvii
1. Overview	1
A Reality Center Facility	1
What MPK Provides	3
Run-Time Configurability	3
Run-Time Scalability	4
Integrated Support for Scalable Graphics Hardware	4
Integrated Support for Stereo and Immersive Environments	4
Components of MPK	5
Application Structure	5
A Sample Configuration File	6
2. Framebuffer Resources	9
The MPK Configuration Hierarchy	9
The <code>config</code> Data Structure	12
The <code>pipe</code> Data Structure	12
The <code>window</code> Data Structure	13
The <code>channel</code> Data Structure.	14
Stereo Description	15

3.	Frustum Descriptions	. 17
	Orthographic Versus Perspective Frusta.	. 18
	A Frustum in Immersive Environments	. 20
	Two Modeling Methods	. 22
	Specifying Wall Model Coordinates.	. 23
	Specifying Projection Model Coordinates	. 24
	Examples of Common Reality Center Settings	. 26
4.	Compounds	. 31
	Scalable Rendering	. 31
	Building Compounds	. 32
	Frame Decomposition.	. 34
	Screen Decomposition	. 34
	Database Decomposition.	. 36
	Eye Decomposition	. 38
	Temporal Decomposition.	. 40
	Frame Multiplexing	. 40
	Data Streaming	. 43
	Pixel-Based Decomposition	. 44
	Full-Scene Antialiasing (FSAA) Decomposition	. 45
	FSAA Compound Examples.	. 45
	Cull Decomposition	. 47
	Multilevel Decomposition	. 49
	Stereo-Selective Compounds	. 52
	Automatic Load Balancing for Compounds.	. 53
	Dynamic and Static Load Balancing.	. 53
	Proper Environment for Automatic Load Balancing	. 54
	How to Enable Automatic Load Balancing	. 55
	Using a Split-Axis Method for Tiling	. 55
	Choosing the Right Decomposition Model	. 57
5.	Using Scalable Graphics Hardware	. 59
	Using MPK with a DPLEX	. 59

Using MPK with an SGI Scalable Graphics Compositor	60
General Capabilities	60
Hardware Spatial Composition Schemes	61
MPK Specifications	62
6. Configuration File Format	65
File Format	65
Specifying Comments (#)	65
Specifying Delimiters.	65
Specifying MPK Data Structures	66
Specifying Values within a Field	67
Defining MPK Data Structures	68
The <code>config</code> Data Structure	69
The <code>pipe</code> Data Structure.	70
The <code>window</code> Data Structure	72
The <code>channel</code> Data Structure	78
The <code>compound</code> Data Structure	83
Specifying Global Attributes	87
Index	97

Figures

Figure 1-1	SGI Reality Center	2
Figure 1-2	MPK Application Structure	6
Figure 2-1	MPK Configuration Hierarchy	10
Figure 3-1	An Orthographic Frustum.	18
Figure 3-2	A Perspective Frustum.	19
Figure 3-3	Projections through the Near Plane	20
Figure 3-4	The Effective Frustum	22
Figure 3-5	TANORAMA® POWERWALL (TAN/SGI Democenter)	26
Figure 3-6	TAN HOLOBENCH® (photo courtesy of GMD)	27
Figure 3-7	SGI Reality Center	28
Figure 3-8	V-Dome™ (designed and installed by Trimension Systems, Inc.)	29
Figure 3-9	Responsive Workbench® (photo courtesy of DaimlerChrysler AG)	30
Figure 4-1	Source and Destination Channels	32
Figure 4-2	Screen Decomposition	35
Figure 4-3	Database Decomposition	37
Figure 4-4	Eye Decomposition.	39
Figure 4-5	Frame Multiplexing Decomposition	41
Figure 4-6	Data Streaming Decomposition	43
Figure 4-7	4x FSAA Decomposition	46
Figure 4-8	Eye-DB Multilevel Decomposition	50
Figure 4-9	Dynamic Versus Static Load Balancing	54
Figure 4-10	2D Tiling Scheme with Four Regions and Horizontal Tiles	56
Figure 4-11	2D Tiling Scheme with Four Regions and Vertical Tiles	57
Figure 5-1	Hardware Spatial Composition Schemes	62

Tables

Table 6-1	Field Types and Formats	67
Table 6-2	The <code>config</code> Fields	69
Table 6-3	The <code>pipe</code> Fields	71
Table 6-4	The <code>window</code> Fields	73
Table 6-5	Window Attributes— <code>hints</code> Subfields	74
Table 6-6	Window Attributes— <code>planes</code> Subfields	76
Table 6-7	Window Attributes— <code>transparent</code> Subfields.	77
Table 6-8	The <code>channel</code> Fields	79
Table 6-9	Channel Attributes— <code>read</code> Subfields	81
Table 6-10	The <code>compound</code> Fields	83
Table 6-11	MPK Global Attributes	88

About This Guide

SGI OpenGL Multipipe SDK (MPK) is a software development toolkit (SDK) that allows you to adapt your graphics applications to run in immersive environments and to take advantage of the scalability provided by multiple pipes and other scalable graphics hardware. This guide describes how to use and configure an MPK application.

Audience

This guide targets Reality Center administrators. As such, you can configure graphics applications to run in multipipe environments. Using MPK, you can describe the physical display area (walls), the hardware resources, and the rendering options.

What This Guide Contains

This guide is divided into the following chapters:

- Chapter 1, “Overview,” describes the features of MPK and its components.
- Chapter 2, “Framebuffer Resources,” describes the function and hierarchy of the framebuffer data structures for pipes, windows, and channels.
- Chapter 3, “Frustum Descriptions,” describes a frustum in a virtual reality environment and two methods for computing a frustum for a projection system.
- Chapter 4, “Compounds,” describes the various schemes of decomposition available under MPK.
- Chapter 5, “Using Scalable Graphics Hardware,” describes the use of compounds with scalable graphics hardware.
- Chapter 6, “Configuration File Format,” describes the format of an MPK configuration file.

Related Publications

The following books contain additional information that may be helpful:

- *SGI OpenGL Multipipe SDK Programmer's Guide*
- *SGI InfinitePerformance: Scalable Graphics Compositor User's Guide*
- *Onyx2 DPLEX Option Hardware User's Guide*
- *IRIX Admin: Software Installation and Licensing*
- *OpenGL Multipipe User's Guide*

Obtaining Publications

You can obtain SGI documentation in the following ways:

- See the SGI Technical Publications Library at <http://docs.sgi.com>. Various formats are available. This library contains the most recent and most comprehensive set of online books, release notes, man pages, and other information.
- If it is installed on your SGI system, you can use InfoSearch, an online tool that provides a more limited set of online books, release notes, and man pages. With an IRIX system, select **Help** from the Toolchest, and then select **InfoSearch**. Or you can type `infosearch` on a command line.
- You can also view release notes by typing either `grelnotes` or `relnotes` on a command line.
- You can also view man pages by typing `man <title>` on a command line.

Conventions

The following conventions are used throughout this publication:

Convention	Meaning
<code>command</code>	This fixed-space font denotes literal items such as commands, files, routines, path names, signals, messages, and programming language structures.

<i>variable</i>	Italic typeface denotes variable entries and words or concepts being defined.
user input	This fixed-space font denotes literal items that the user enters in interactive sessions. (Output is shown in nonbold, fixed-space font.)
function	Functions are denoted in bold with following parentheses.
manpage(<i>x</i>)	Man page section identifiers appear in parentheses after man page names.

Reader Comments

If you have comments about the technical accuracy, content, or organization of this document, contact SGI. Be sure to include the title and document number of the manual with your comments. (Online, the document number is located in the front matter of the manual. In printed manuals, the document number is located at the bottom of each page.)

You can contact SGI in any of the following ways:

- Send e-mail to the following address:
techpubs@sgi.com
- Use the Feedback option on the Technical Publications Library webpage:
<http://docs.sgi.com>
- Contact your customer service representative and ask that an incident be filed in the SGI incident tracking system.
- Send mail to the following address:
Technical Publications
SGI
1600 Amphitheatre Parkway, M/S 535
Mountain View, CA 94043-1351
- Send a fax to the attention of “Technical Publications” at +1 650 932 0801.

SGI values your comments and will respond to them promptly.

Overview

This overview of OpenGL Multipipe SDK (MPK) consists of the following sections:

- “A Reality Center Facility”
- “What MPK Provides”
- “Components of MPK”
- “Application Structure”
- “A Sample Configuration File”

A Reality Center Facility

Throughout this document, we shall use the term Reality Center facility to convey the following meaning: an SGI computer environment with extended visualization capabilities. Note that this definition not only applies to the traditional three-pipe theater (historically set up for flight simulation) but covers as well all kinds of immersive environments (such as a Cave, TANORAMA POWERWALL, or TAN HOLOBENCH facility) and also extends to encompass graphics clusters. Figure 1-1 on page 2 illustrates an SGI Reality Center facility.



Figure 1-1 SGI Reality Center

What MPK Provides

As more and more graphics applications come into the virtual reality arena as a piece of immersive solutions, application developers face new requirements. Not only do developers need to take into account high frame rates and low latencies needed for temporal realism, but also better image quality for visual realism. OpenGL applications must improve their performances and must be able to run in increasingly complex environments that include various input peripherals and projection systems. For applications initially designed to run on a visual workstation in non-real time and with keyboard-mouse input, new releases now need to be time-accurate and should be able to integrate a moving frustum tied to head-tracking peripherals and several rendering engines (graphics pipes) that provide multiple and wider fields of view. Because these types of evolving environments have numerous parameters, the applications must be sufficiently flexible and robust to accommodate their demands.

MPK is an application programming interface (API) designed to help software developers meet the demands of these new immersive environments. This product enables the application to take advantage of the scalability provided by additional pipes and other scalable graphics hardware, as well as to support immersive environments. MPK provides the following specific features:

- Run-time configurability
- Run-time scalability
- Integrated support for scalable graphics hardware
- Integrated support for stereo and immersive environments

Run-Time Configurability

MPK allows developers to create applications that run on multiple platforms ranging from simple visual workstations to large and complex visualization environments, often based on several pipes for parallel rendering purposes. It implements a design that largely isolates the application from the graphics resources and the physical environment. Providing run-time configurability, an application written in the MPK programming model can run on a simple desktop platform or, without any modification or recompilation, in highly complex visualization environments like an SGI Reality Center facility.

Run-Time Scalability

Graphics-intensive applications often require several pipes in order to achieve a desired performance. Each pipe contributes to a part of the final rendering. This introduces the need for a decomposition paradigm and the issue of how the rendering performance scales with the number of pipes. Rendering in parallel requires the developer to manage several graphic contexts and then to create tasks or threads, each managing their own graphic context and sharing the scene to be rendered. MPK allows a multipipe applications developer to avoid dealing with such parallel programming paradigms and offers compound algorithms based on several decomposition types.

Integrated Support for Scalable Graphics Hardware

Scalable graphics hardware such as the SGI Scalable Graphics Compositor and the SGI Video Digital Multiplexer (DPLEX) can perform some of the compositing functions that MPK now provides in software. MPK supports such hardware as well as conventional graphics hardware.

Integrated Support for Stereo and Immersive Environments

Along with its scalability features, MPK has integrated the ability to exploit the stereo features of your application-display environment without recompilation. Having the related display characteristics of your environment described in a configuration file, you can specify at run time whether to run in stereo or mono.

In addition, MPK provides the application with the ability to support truly immersive environments by using a simple programming interface: the application only needs to provide real-world information about the position and orientation of the viewer. MPK then transparently adapts its left- and right-eye frustum computations to the actual user's location.

The ease of configuring your application to accommodate different hardware resources (graphics pipes and head-tracking devices) and different display areas makes MPK ideal for use in immersive environments.

Components of MPK

MPK has two components:

- Application programming interface

Designed for the applications programmer to adapt OpenGL graphics applications to fit the MPK programming model in order to support multipipe environments.

- Configuration file interface

Designed for Reality Center administrators to configure MPK graphics applications to run in their environments. This ASCII file interface allows you to specify how the framebuffer resources (pipes, windows, and channels) are mapped onto the physical projection areas (walls) and the parallel decomposition schemes (compounds) to be used by your applications.

MPK is available on IRIX through C language function calls. It is designed as a thin layer on top of the operating system, X11, OpenGL, and GLX.

Application Structure

As an application will have to run in different configurations, MPK externalizes the configuration management by implementing an ASCII file that is separate from the other application code. The scene management and data workflow is separate from scene rendering (management of the graphics resources). Figure 1-2 illustrates the structure of an application based on MPK.

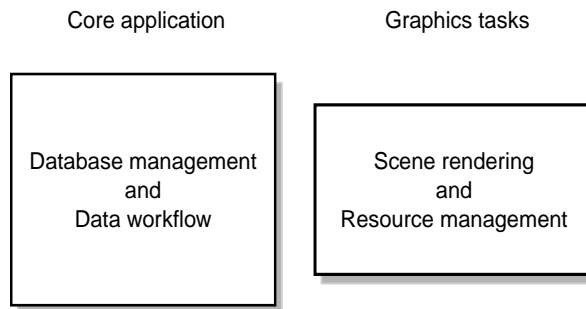

Figure 1-2 MPK Application Structure

A Sample Configuration File

Example 1-1 shows a one-pipe, one-window configuration file that can be used in conjunction with a MPK-structured program—for instance, `volview`, a scalable volume-viewer application packaged as part of the OpenGL Volumizer 2 product.

Example 1-1 Sample Configuration File

```
global {
    MPK_WATTR_PLANES_ALPHA 1
    MPK_DEFAULT_EYE_OFFSET 0.01
}
config {
    name "Volview: 1-pipe"
    mode mono

    mono "/usr/gfx/setmon -n 1280x1024_76"
    stereo "/usr/gfx/setmon -n str_top"
    pipe {
        window {
            viewport [ 0, 0, 1.0, 1.0 ]
            channel {
                name "center"
                viewport [ 0., 0., 1., 1. ]
                wall {
                    bottom_left [ -.5, -.5, -1 ]
                    bottom_right [ .5, -.5, -1 ]
                    top_left [ -.5, .5, -1 ]
                }
            }
        }
    }
}
```

Framebuffer Resources

As noted in the overview, MPK allows you to describe the framebuffer resources (pipes, windows, and channels), the physical display area (walls), and the rendering options. This chapter describes how you configure the framebuffer resources and contains the following sections:

- “The MPK Configuration Hierarchy”
- “The config Data Structure”
- “The pipe Data Structure”
- “The window Data Structure”
- “The channel Data Structure”
- “Stereo Description”

The MPK Configuration Hierarchy

The MPK configuration file uses a tree data structure to describe the physical graphics resources. The root of the data structure is the whole visualization facility and the leaves are the physical rendering layouts. Figure 2-1 shows the configuration of an application running on a two-pipe platform, two windows handling the GLX context, and four channels.

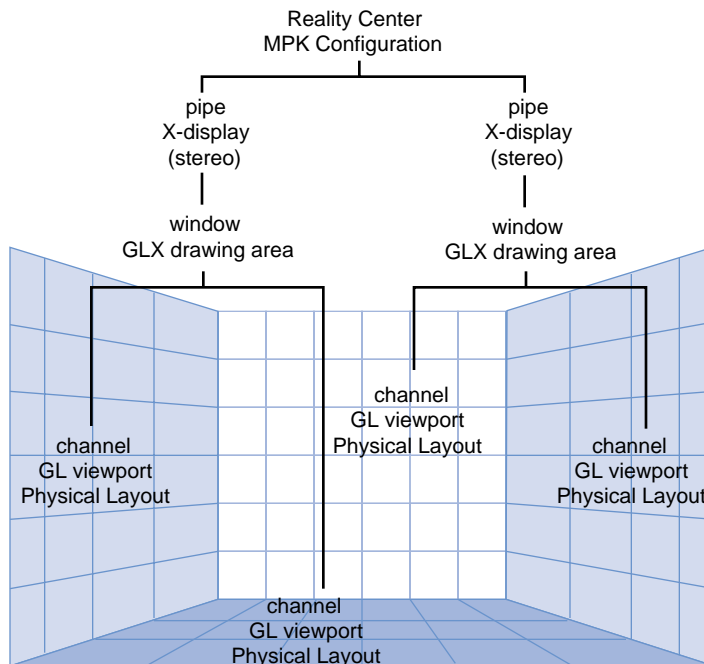

Figure 2-1 MPK Configuration Hierarchy

Example 2-1 shows a skeletal configuration file that describes Figure 2-1.

Example 2-1 Skeletal Configuration File

```
config {
  pipe {
    window {
      viewport [ parameters1 ]
      channel {
        viewport [ parameters2 ]
        .
        .
      }
      channel {
        viewport [ parameters3 ]
        .
        .
      }
    }
  }
  pipe {
    window {
      viewport [ parameters4 ]
      channel {
        viewport [ parameters5 ]
        .
        .
      }
      channel {
        viewport [ parameters6 ]
        .
        .
      }
    }
  }
}
```

Reading this configuration file, MPK determines the following:

- What physical pipes it must allocate
- What parallel tasks it must create
- How to synchronize the rendering tasks
- The final rendering framebuffer area

The following sections describe the function of the framebuffer data structures and Chapter 6, “Configuration File Format” describes their syntax for the configuration file.

The `config` Data Structure

The configuration level of the hierarchy, denoted in the configuration file by the `config` data structure, primarily describes the rendering resources of an MPK application as a hierarchy of the following:

- Hardware rendering pipelines (pipes)
- GLX software rendering threads (windows)
- OpenGL framebuffer rendering areas (channels)

It may also describe compounds, various parallelization schemes of the rendering across channels in order to scale performances. Chapter 4, “Compounds” describes the use of compounds in MPK.

As shown in Figure 2-1, pipes are children of the root configuration, windows are children of pipes, and channels are children of windows. As such, you can take advantage of the attendant inheritance. For instance, you can specify the screen dimensions at the pipe level and they will be inherited by the child windows and child channels. This inheritance is made possible because MPK uses no absolute pixel dimensions but fractional viewport descriptions for its window and channels.

The `pipe` Data Structure

A `pipe` data structure describes the rendering resources within a configuration that are assigned to a given hardware rendering pipe. You must have one `pipe` entry for every pipe you want to use in your configuration. The pipe itself is characterized by the name

of its corresponding X11 display as well as the expected mono and stereo mechanisms (full-screen, quad-buffer, and the like) to be applied by its rendering threads (windows).

Example 2-2 shows a minimal pipe specification that is superior to that of the windows and channels.

Example 2-2 Sample Pipe Specification

```
pipe {
    display      ":0.0"
    window {
        .
        .
        .
        channel {
            .
            .
            .
        }
    }
}
```

You can specify the display sizes corresponding to the various stereo modes using global attributes or pipe attributes; otherwise, MPK uses the values returned by the X11 **DisplayWidth()** and **DisplayHeight()** functions. Chapter 6, “Configuration File Format” describes the pipe and global attributes.

The window Data Structure

A window data structure corresponds to a single GLX unit (that is, a single X window with its associated OpenGL visual and context). Essential in the MPK programming model is that each window spawns its own rendering thread.

In the configuration file, the window specification is subordinate to the pipe specification. Example 2-3 shows a minimal specification. Other optional specifications include the processor where the rendering thread is to run and an extensive set of window attributes. Chapter 6, “Configuration File Format” describes the complete set of fields and their syntax.

Example 2-3 Sample Window Specification

```
window {
    viewport    [ 0., 0., 1., 1. ]
    channel {
        .
        .
        .
    }
}
```

The channel Data Structure

A channel, denoted by a `channel` data structure in the configuration file, is essentially a view onto a scene and corresponds to a single viewport inside its parent window. In addition to the viewport description, a channel also contains the modeling coordinates for the projection rectangle in the real world. Chapter 3, “Frustum Descriptions” describes how you describe these coordinates.

Note: MPK allows applications to run in mirrored projection systems, which usually use mirrors to invert the projected image up and down (with respect to left and right) . To do this, you must specify a negative value for the height or width of the corresponding channel’s viewport.

Example 2-4 shows a sample channel specification.

Example 2-4 Sample Channel Specification

```
channel {
    viewport    [ 0., 0., 1., 1. ]
    projection {
        origin   [ 0., 0., 0. ]
        distance 3.
        fov      [ 54., 47. ]
        hpr      [ 0., 0., 0. ]
    }
}
```

Chapter 6, “Configuration File Format” describes the complete set of fields and their syntax.

Stereo Description

When running an MPK application in stereo mode, you can specify two elements from the configuration file:

- Stereo type

This indicates how the framebuffer resources are configured for each eye pass. The stereo type is defined as a pipe attribute either in the global attributes section or per pipe in the `pipe` data structure. Chapter 6, “Configuration File Format” contains a detailed list of all attributes and describes how to specify global attributes.

- Stereo command

This command will be executed by MPK when switching to mono or stereo rendering. The command is specified for mono and stereo in the `config` data structure.

Note: If you want to run in quad-buffered stereo mode, your windows must allocate stereo-capable visuals. This can be specified using the `stereo` window attribute hint.

The following is an example of stereo specifications in the `config` data structure:

```
mono "/usr/gfx/setmon -n 60HZ"  
stereo "/usr/gfx/setmon -n 1024x768_96s"
```

Controlling the stereo specifications at the configuration or pipe levels requires you to kill windows and restart them. However, you can switch stereo on and off without killing them if all windows on all quad-stereo pipes have a quad-buffer-capable GLX visual and you use the window `hint` attribute, as shown in the following:

```
attributes {  
    hints {  
        stereo 1  
    }  
}
```

See Chapter 6, “Configuration File Format” for a complete description of the options and their syntax.

Frustum Descriptions

To allow graphical applications to behave properly in immersive environments, you must specify the physical layout of the display area and the relative position of the observer. MPK allows you to do this by extending the notion of the viewing frustum in a graphical application. This chapter uses the following sections to describe this task:

- “Orthographic Versus Perspective Frusta”
- “A Frustum in Immersive Environments”
- “Two Modeling Methods”
- “Examples of Common Reality Center Settings”

As described in Chapter 6, “Configuration File Format”, MPK expects a frustum description as part of the `channel` data structure.

Orthographic Versus Perspective Frusta

Figure 3-1 depicts an orthographic frustum.

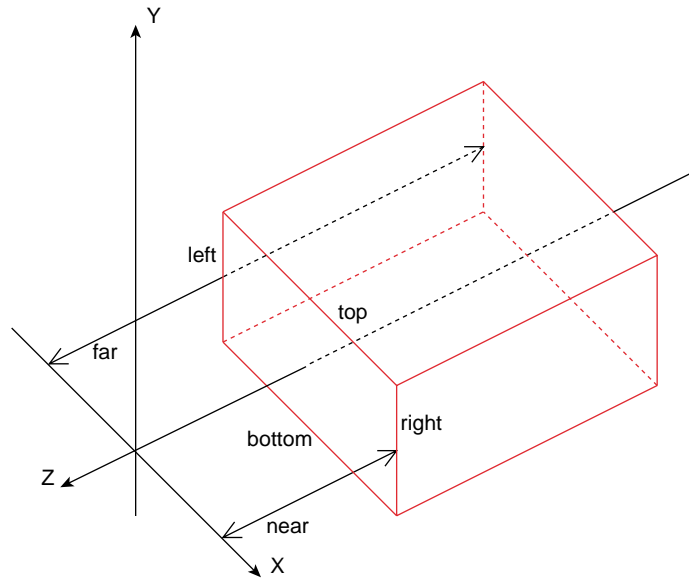

Figure 3-1 An Orthographic Frustum

Figure 3-2 depicts a perspective frustum.

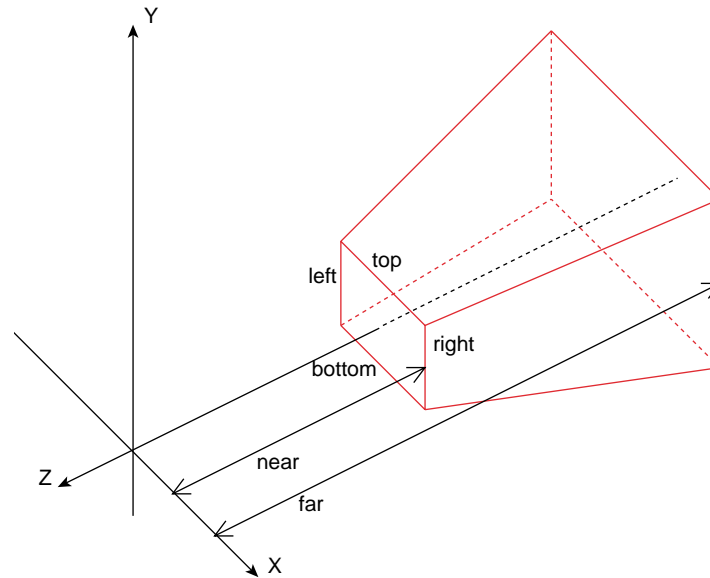

Figure 3-2 A Perspective Frustum

Note the following about the two frusta:

- Both are totally defined by the *near*, *far*, *left*, *right*, *top*, and *bottom* distances and the assumption of having the eyepoint at the origin and the *near* and *far* distances for each defined with respect to the Z axis. The OpenGL near and far planes are always parallel to each other and perpendicular to the Z axis. An off-axis OpenGL frustum corresponds to the case where the near-plane rectangle is not centered around the Z axis. This is generally the case in immersive environments. See Figure 3-4 on page 22 for an example of an off-axis frustum.
- Both final images (pixmap) correspond to the near plane image.
- In the case of a perspective frustum and as illustrated in Figure 3-3, the near plane intersection with a line from the eyepoint to the scene graph object defines the pixel color. Distant objects appear smaller in the pixmap.
- In the case of an orthographic frustum and as illustrated in Figure 3-3 also, the near plane intersection with a line parallel to the Z axis and extending to the scene graph

object defines the pixel color. The size of objects is preserved in the orthographic view.

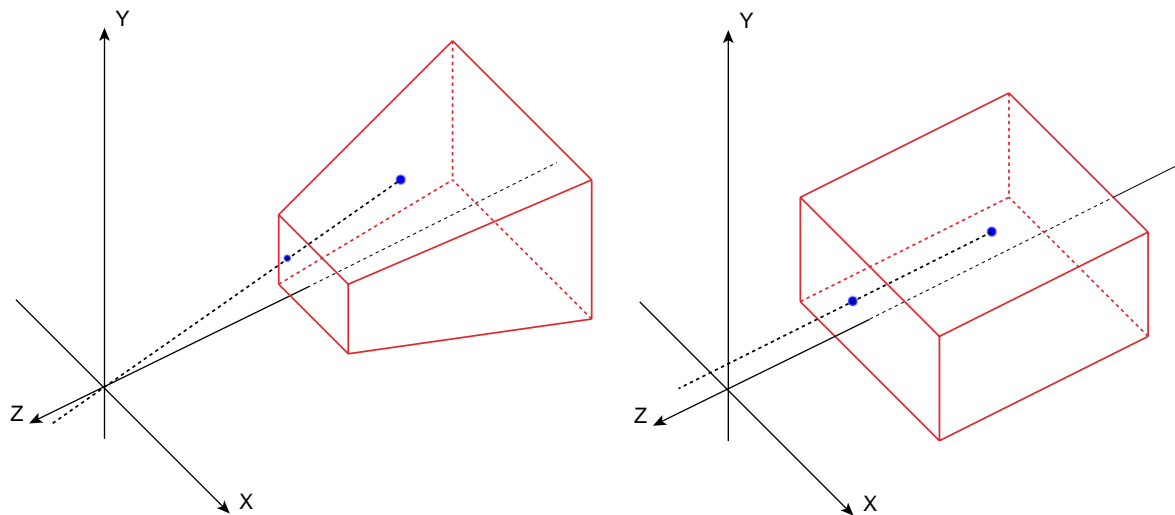

Figure 3-3 Projections through the Near Plane

Given these definitions of a pixmap, you control the appearance of the pixmap by selecting the type of frustum and setting the frustum parameters (*near*, *far*, *left*, *right*, *top*, and *bottom*).

In non-immersive environments, the location of the eyepoint and monitor screen in the real world is arbitrary and you do not need to account for it.

A Frustum in Immersive Environments

In non-immersive environments, you have arbitrary (usually symmetric) *left*, *right*, *top*, and *bottom* parameters.

In an immersive environment, you need to establish the location of the eyepoint and the monitor in real-world coordinates; they are no longer arbitrary. The monitor screen is now a see-through glass window into the scene graph. Figure 3-4 on page 22 illustrates

the new effective frustum, which is completely determined by the following specifications:

- *near* and *far* distances
- Real-world eyepoint location
- Real-world screen position

MPK expects the dimensions (position and size) of the screen to be specified as part of the associated channel's data structure—that is, as if the screen itself was a 3D object in your database. You must specify the same units and coordinate system as will be used by the application when drawing the database.

MPK allows the eyepoint location to be specified using a simple programming interface. The application needs only to provide real-world information about the position and attitude of the viewer. MPK then transparently adapts its left- and right-eye frustum computation.

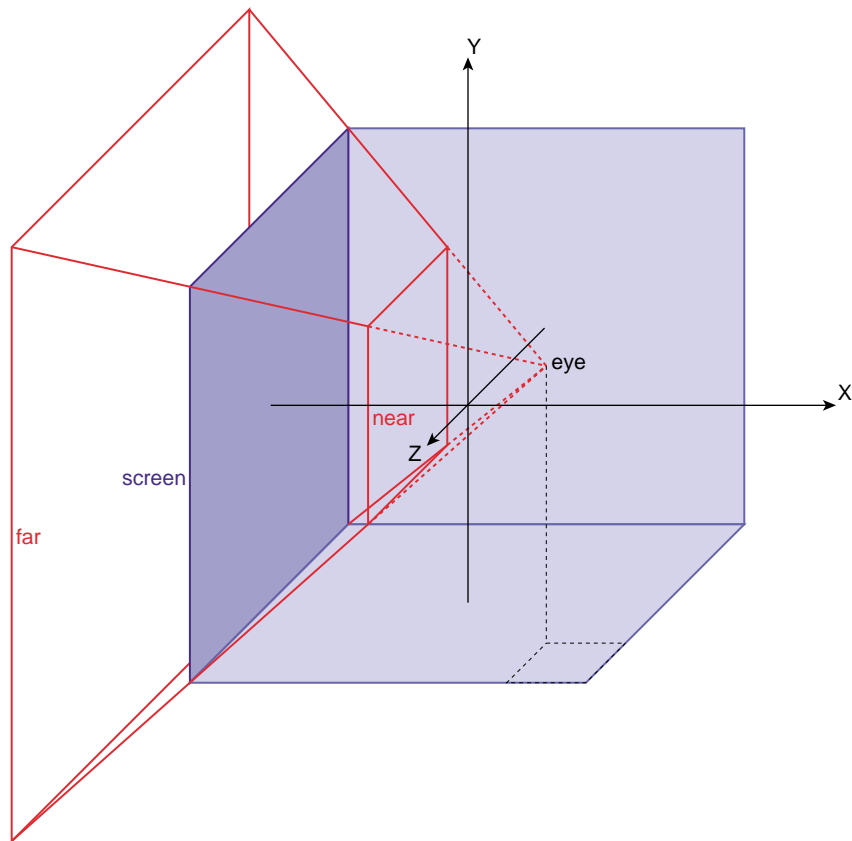

Figure 3-4 The Effective Frustum

Two Modeling Methods

MPK provides two modeling methods to describe your projection system:

- Wall model (Cartesian coordinates)
- Projection model (polar/cylindrical/spherical coordinates)

The most appropriate modeling method usually corresponds to the one requiring fewer manual computations in order to describe the geometry of your environment.

Specifying Wall Model Coordinates

Wall model coordinates are well-suited to describe projection screens that are arranged as flat screens, such as in a TANORAMA POWERWALL or TAN HOLOBENCH facility. To describe a projection screen using the wall model, you need to provide the Cartesian coordinates of three of its vertices using object data coordinates (x',y',z'):

- Bottom-left vertex
- Bottom-right vertex
- Top-left vertex

Example 3-1 shows an example of using wall model coordinates in a configuration file for a wall that is 3 meters by 3 meters and 1.5 meter in front of the viewer. The example assumes that the application expects the coordinates to be specified in meters:

Example 3-1 Specifying Wall Model Coordinates

```
# a 3m x 3m screen located 1.5 m in front of the viewer
#
wall {
    bottom_left    [ -1.5, -1.5, -1.5 ]
    bottom_right   [  1.5, -1.5, -1.5 ]
    top_left       [ -1.5,  1.5, -1.5 ]
}
```

Specifying Projection Model Coordinates

Projection model coordinates are well-suited to describe projection screens that are in a curved or tilted arrangement, such as in the traditional three-pipe SGI Reality Center, the V-Dome, and the Responsive Workbench facilities. To describe a projection screen using the projection model, you need to provide the following information:

- Origin in Cartesian coordinates, using object data coordinates (x', y', z')
- Euler angles of the projection plane—that is, the counter-clockwise rotation around the Y axis (heading), X axis (pitch), and Z axis (roll) viewed from the positive side of the axis
- Distance of the projection plane from the origin in the application's measurement units
- Horizontal and vertical fields of view (FOV)

Example 3-2 shows an example of using projection model coordinates in a configuration file. The configuration is a three-channel, hemi-cylindrical Reality Center with the following dimensions:

Dimension	Value
Radius	3 meters
Edge blending	8 percent
Horizontal FOV	54 degrees (total FOV of 150 degrees)
Vertical FOV	47 degrees

Example 3-2 Specifying Projection Model Coordinates

```
channel {
  name "front-view"
  projection {
    origin    [ 0., 0., 0. ]
    distance  3.
    fov       [ 54., 47. ]
    hpr       [ 0., 0., 0. ]
  }
}
channel {
  name "left-view"
  projection {
    origin    [ 0., 0., 0. ]
    distance  3.
    fov       [ 54., 47. ]
    hpr       [ 50., 0., 0. ]
  }
}
channel {
  name "right-view"
  projection {
    origin    [ 0., 0., 0. ]
    distance  3.
    fov       [ 54., 47. ]
    hpr       [ -50., 0., 0. ]
  }
}
```

For each specified channel, the resulting projection area corresponds to the rectangle that would be produced by a hypothetical projection system located at `origin` with the orientation characterized by the `hpr` angles and projecting orthogonally onto a wall situated at `distance`.

Examples of Common Reality Center Settings

There are a variety of commercial products that illustrate the most appropriate choice for the two modeling methods. Figure 3-5 and Figure 3-6 illustrate flat-screen arrangements that are ideal for the use of the wall model.



Figure 3-5 TANORAMA® POWERWALL (TAN/SGI Democenter)

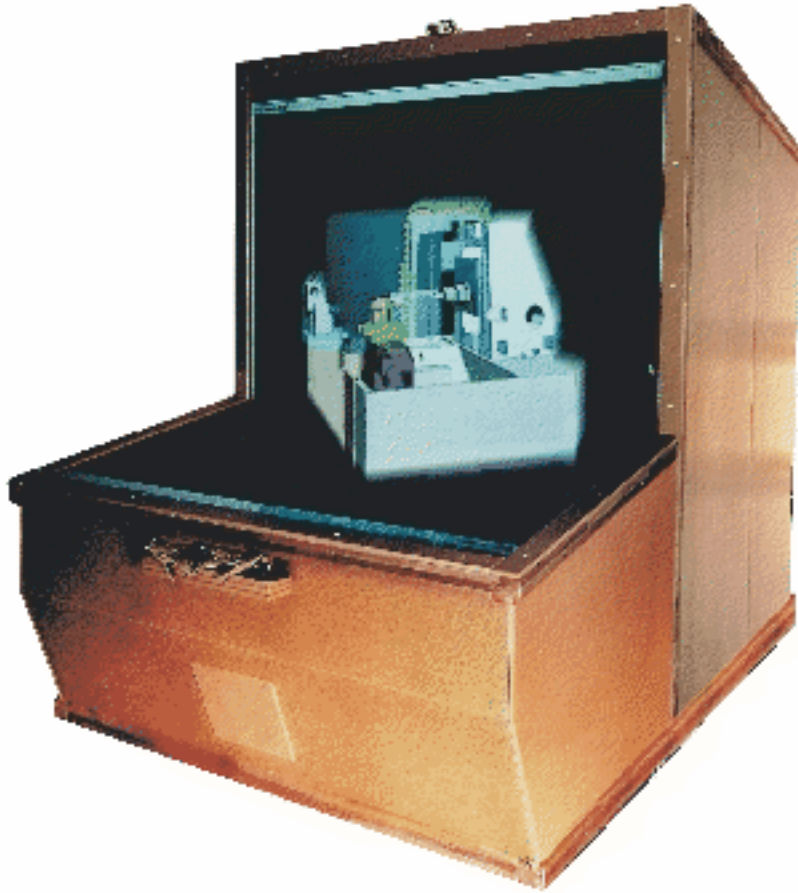

Figure 3-6 TAN HOLOBENCH® (photo courtesy of GMD)

Figure 3-7, Figure 3-8, and Figure 3-9 illustrate curved or tilted arrangements of projection screens and are ideal for the use of the projection model.



Figure 3-7 SGI Reality Center

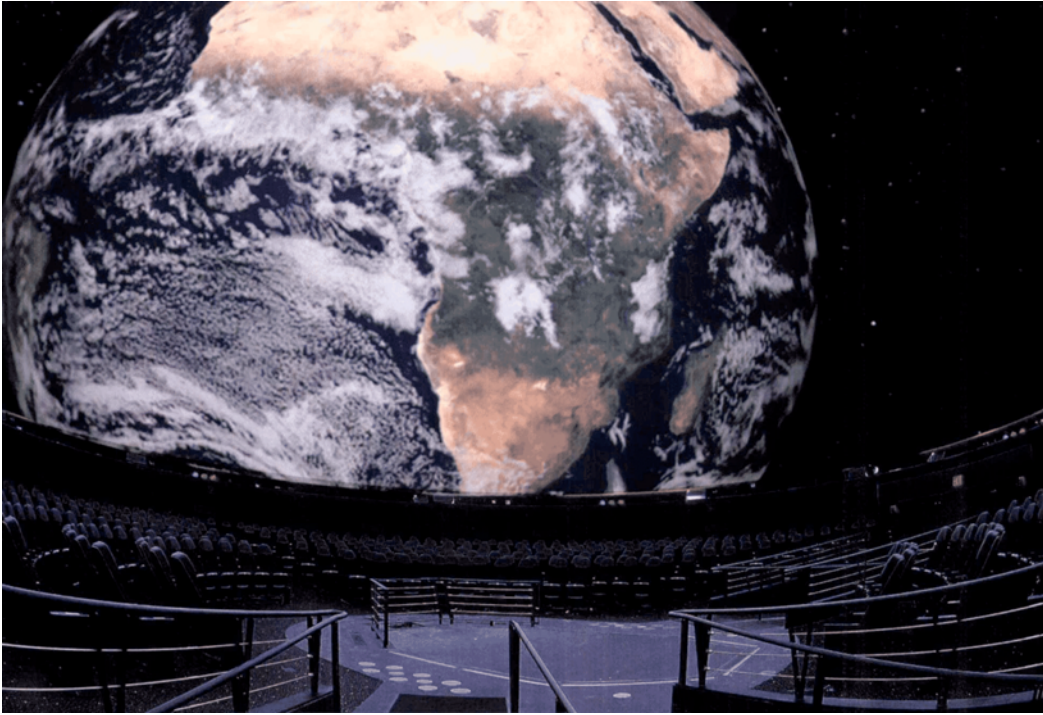

Figure 3-8 V-Dome™ (designed and installed by Trimension Systems, Inc.)

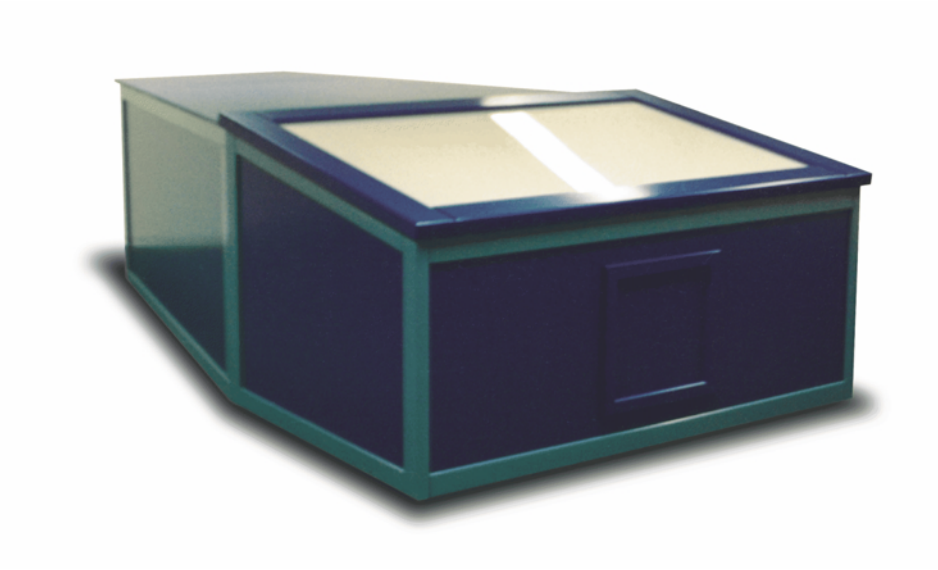

Figure 3-9 Responsive Workbench® (photo courtesy of DaimlerChrysler AG)

Compounds

This chapter describes how you can use compounds (or conversely, decomposition) to scale the performance of your graphics system. Decomposition allows you to use multiple pipes to render frames that would normally be rendered by a single pipe.

This chapter has the following sections:

- “Scalable Rendering”
- “Building Compounds”
- “Stereo-Selective Compounds”
- “Automatic Load Balancing for Compounds”
- “Choosing the Right Decomposition Model”

Scalable Rendering

To achieve greater application performance, MPK allows you to decompose a global rendering task into smaller tasks and to assign the smaller tasks to individual pipes. The task division requires a decomposition scheme. In general, a decomposition scheme sends a scene to render to each pipe, gets back rendered images from each pipe for further composition, and then renders the final image. An exception is cull decomposition, where the cull operation is parallelized with the draw operation.

Figure 4-1 illustrates the role of *source* and *destination* channels in scalable rendering.

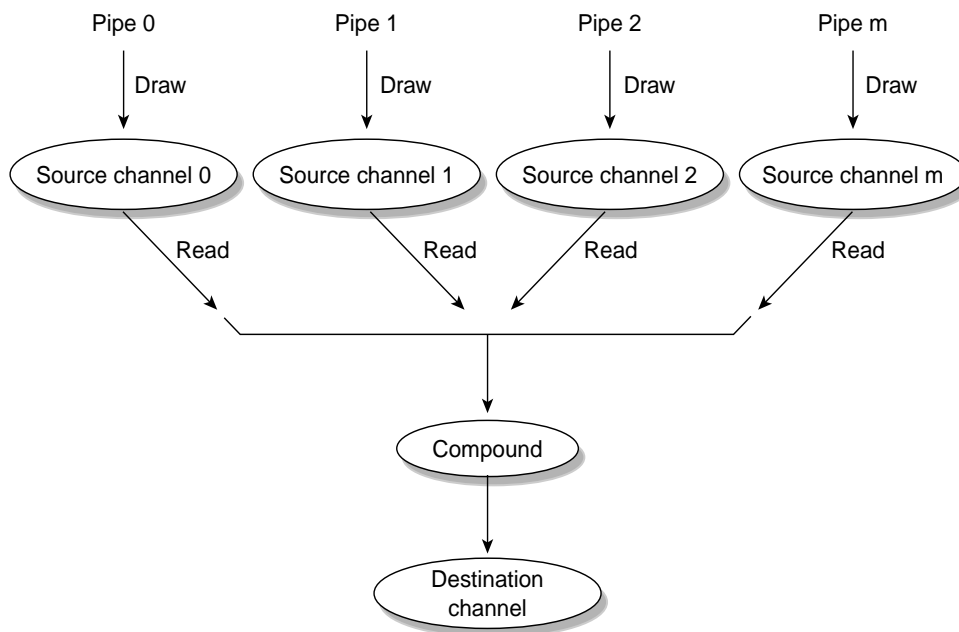

Figure 4-1 Source and Destination Channels

Building Compounds

To build a compound, you must create a compound data structure. Chapter 6, “Configuration File Format” describes the syntax of compound data structures for your configuration file. This section describes how you build them logically.

Generally, to create a compound, you need to do the following:

1. Choose a decomposition scheme, which divides the global rendering task into smaller tasks.
2. Distribute the rendering of the smaller tasks to the source pipes for parallel processing.
3. Designate a destination channel for the reassembly of the final, coherent image.

The destination channel is usually one of the source channels. To achieve optimal performances, you would usually have one channel per pipe.

This chapter focuses on the three tasks just cited. Optionally, you can also do the following:

- Indicate whether your compound is used in only stereo or mono mode.
- Indicate controls for the pixel data transfers between the compound and its regions.
- Indicate whether to use scalable graphics hardware.
- Indicate whether to use automatic load balancing.

The section “Stereo-Selective Compounds” on page 52 describes how you control whether your compound is used depending on the stereo mode of the application. For more information on the first two optional tasks, see the descriptions of the mode and format fields in section Chapter 6, “Configuration File Format”. Chapter 5, “Using Scalable Graphics Hardware” describes the integration of scalable graphics with MPK. “Automatic Load Balancing for Compounds” on page 53 describes how MPK balances the rendering for certain compound modes.

MPK provides several decomposition schemes and the following subsections describe these schemes:

- “Frame Decomposition”
- “Temporal Decomposition”
- “Pixel-Based Decomposition”
- “Cull Decomposition”
- “Multilevel Decomposition”

Each decomposition mode improves performance or graphics quality, but the performance gain depends on the application type and the nature of the performance bottleneck. Four factors are important in choosing the decomposition scheme judiciously:

Factor	Description
Load balancing	For a given decomposition, each pipe should execute roughly the same amount of work since the slowest pipe dictates the overall performance. Unbalanced decomposition can seriously affect the scalability.

Scalability of scheme	Scalability is the degree to which the performance grows as the number of graphics resources increases. To optimize performance, you only add resources to address the source of the bottleneck. For example, adding more geometry power to an application limited by pixel fill will not improve performance.
Latency added	Depending on the decomposition scheme, the frame delay between a user input and the associated frame output may be greater than one frame. Minimizing this latency may be critical for some event-driven applications.
Graphics I/O consumption	A typical decomposition involves the reading and writing of images from the source channels (contributing channels) to a destination channel. This transfer might stress the graphics I/O and memory capabilities of the system.

Frame Decomposition

In frame decomposition, a frame or view is divided into regions, which are, in turn, assigned to individual source pipes for rendering. Based on the following perspectives, there are several approaches to dividing the frame into regions:

- Screen topology (screen decomposition)
- Scene graph primitives (database decomposition)
- Eye view (eye decomposition)

Each approach yields a different flavor of frame decomposition.

Screen Decomposition

In screen decomposition (also referred to as 2D decomposition), each pipe renders a part of the screen area. Assembling side-to-side each image part constitutes the final rendering. This type of decomposition is used when the intrinsic pixel fill or geometry capacity of each pipe slows down the application. The scalability depends on the balancing of the workloads. The model to display needs to be uniformly distributed across the screen to accommodate a good balancing and, thus, scalability. The graphics I/O is relatively low, because the traveling source images are small.

Figure 4-2 illustrates screen decomposition.

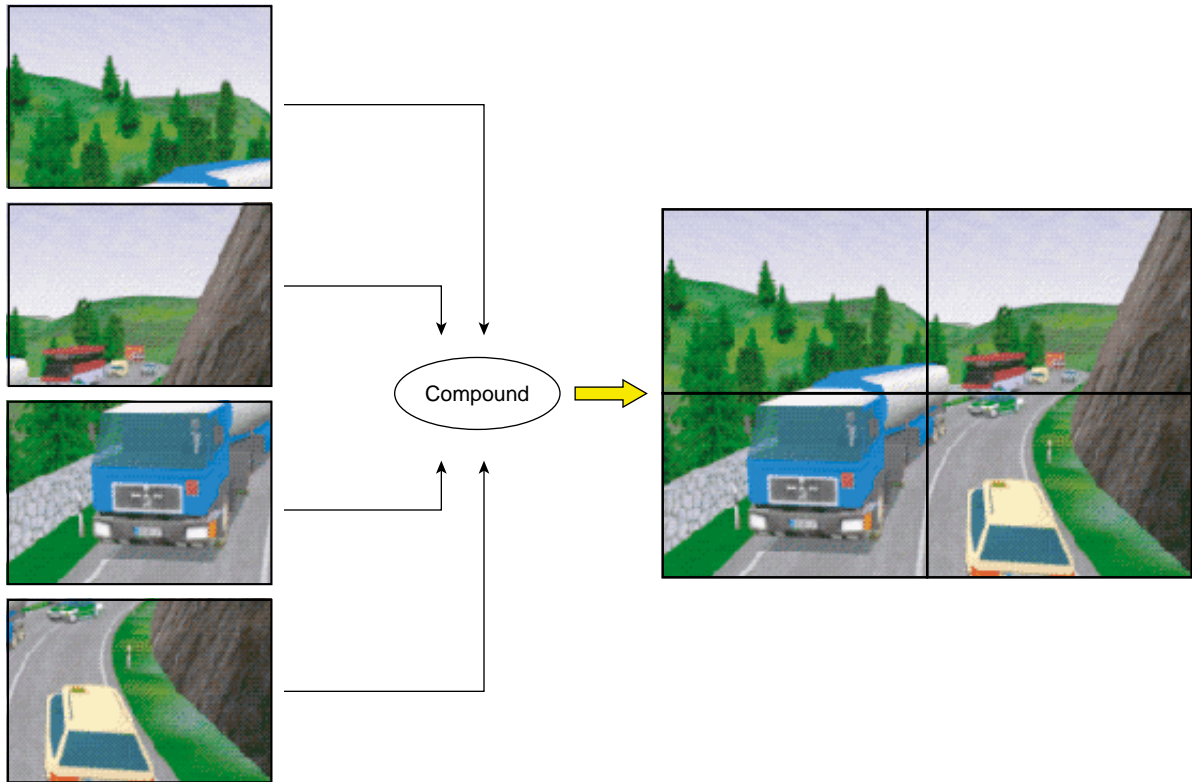

Figure 4-2 Screen Decomposition

Example 4-1 shows the configuration file specifications for the screen decomposition illustrated in Figure 4-2.

Example 4-1 2D Compound in a Configuration File

```
compound {
    mode [2D]
    channel "destination"

    # The top left of "destination" image will be
    # rendered on "source0"...
    region {
        viewport [ 0., .5, .5, .5 ]
        channel "source0"
    }

    # The top right of "destination" image will be
    # rendered on "source1"...
    region {
        viewport [ .5, .5, .5, .5]
        channel "source1"
    }

    # The bottom left of "destination" image will be
    # rendered on "source2"...
    region {
        viewport [ 0., 0., .5, .5 ]
        channel "source2"
    }

    # ... while "destination" itself takes care of
    # the bottom right
    region {
        viewport [ .5, 0., .5, .5 ]
        channel "destination"
    }
}
```

A 2D compound has no frame latency, unless the mode flag `ASYNC` has been set, in which case the latency is one frame but you get better overall performance.

Database Decomposition

In database (DB) decomposition, the scene is rendered in parallel by dividing it among the different graphics pipes. Each pipe renders its share of the scene to generate partial images. These images are then composited by MPK to generate the final image in the destination channel. During composition, the application can use depth testing and/or

alpha blending to achieve the desired effect. Database decomposition allows you to scale both the geometry and the pixel fill performance of the system. For some applications, such as volume rendering, it also scales the texture memory capacity of the system by the number of pipes.

Figure 4-3 demonstrates the use of database decomposition in volume rendering. The volume data is divided equally among the four pipes and the partial images are composited on the destination channel. In this case, the destination channel (top left portion of the figure) is also contributing to the rendering as a source channel.

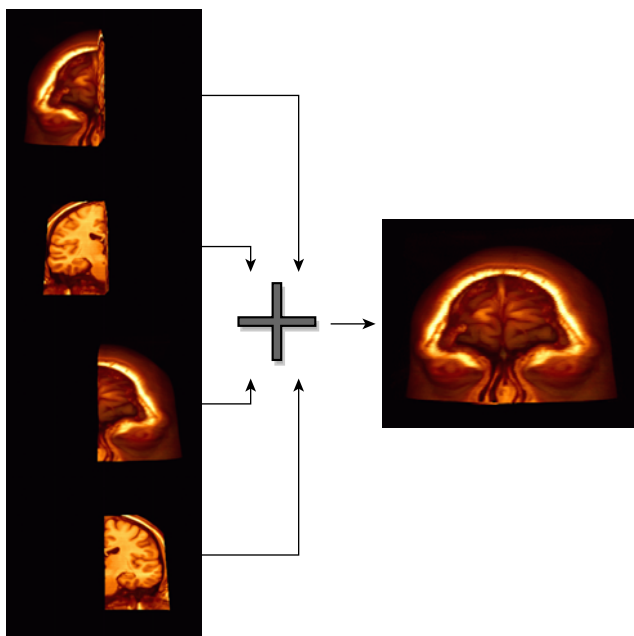

Figure 4-3 Database Decomposition

Example 4-2 shows the configuration file specifications for the database decomposition illustrated in Figure 4-3.

Example 4-2 DB Compound in a Configuration File

```
compound {
  mode      [ DB ]
  format    [ COLOR DEPTH ]
  channel   "channel"

  region {
    range      [ 0., .25 ]
    channel    "buffer0"
  }

  region {
    range      [ .25, .5 ]
    channel    "buffer1"
  }

  region {
    range      [ .5, .75 ]
    channel    "buffer3"
  }

  region {
    range      [ .75, 1. ]
    channel    "channel"
  }
}
```

The application must support the DB compound.

Eye Decomposition

Eye decomposition is well-suited for stereo or multiple-view rendering. Each pipe renders a particular view (left, right, mono). The final rendering depends on the type of display. As illustrated in Figure 4-4, if stereo is active, then each pipe view fills in the right or left buffer of the final rendering. This provides good load balancing and scalability, especially for stereo-view rendering, because the scene content remains similar during run time.

An EYE compound has no frame latency, unless the mode qualifier ASYNC has been specified and pixel transfer needs to occur, in which case the latency is 1.

The number of regions of an eye compound is not limited. If more than one region correspond to the same eye view, MPK uses the first specified region (for this eye) as source for the pixel transfer, if needed.

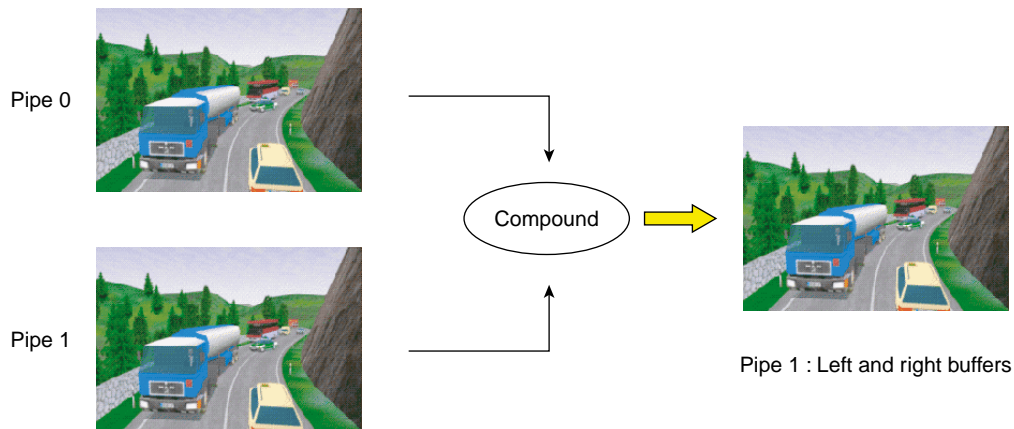

Figure 4-4 Eye Decomposition

Example 4-3 shows the configuration file specifications for the eye decomposition illustrated in Figure 4-4.

Example 4-3 Eye Compound in a Configuration File

```
compound {
    mode    [ EYE STEREO ]
    channel "channel"

    region {
        eye    LEFT
        channel "buffer"
    }

    region {
        eye    RIGHT
        channel "channel"
    }
}
```

Head-Mounted-Device (HMD) decomposition is very similar to that of eye decomposition, except that the head position actually specifies a new origin for the physical layout of the channels.

Example 4-4 shows a configuration file specification for an HMD decomposition:

Example 4-4 HMD Compound in a Configuration File

```
compound {
  mode [HMD]
  channel "destination"

  region {
    eye    left
    channel "source::left"
  }

  region {
    eye    right
    channel "source::right"
  }
}
```

If a destination channel is specified, then the frustum is inherited from the destination channel's wall or projection frustum specification; otherwise, the source channel's frustum specification will be used.

Temporal Decomposition

In contrast to frame decomposition, where the focus of load balancing is on dividing the frame into regions, temporal decomposition balances the workload by scheduling the work on each pipe in sync with that of the other pipes to produce a steady stream of rendered frames. The time scheduling rather than the frame division is the focus. There are two types of temporal decomposition: frame multiplexing and data streaming. The work done by each pipe largely distinguishes the two.

Frame Multiplexing

Frame multiplexing (also referred to as DPLEX decomposition) distributes entire frames to the source pipes over time for parallel processing. The first pipe begins rendering frame 1; a specified fraction of a frame later the second pipe begins rendering frame 2;

another fraction of a frame later the third pipe begins rendering frame 3; and so on for all of the pipes.

Figure 4-5 illustrates frame multiplexing on a four-pipe system.

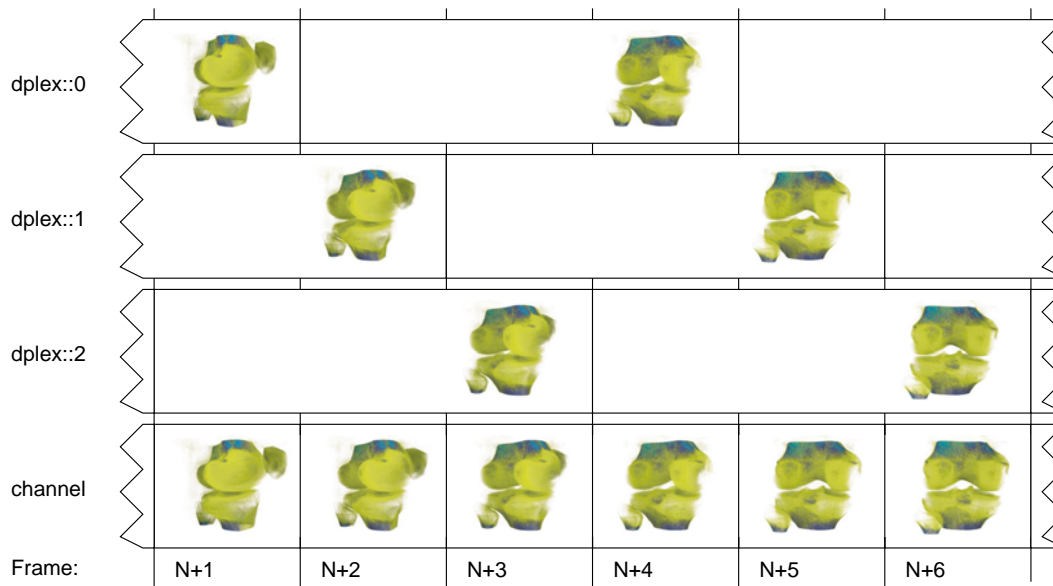

Figure 4-5 Frame Multiplexing Decomposition

Frame multiplexing globally scales geometry and pixel fill performance, as the workload balance between pipes is intrinsically maintained. This scheme has an increased transport delay inherent to frame synchronization required across the pipes. It produces a latency of $(pipes - 1)$ frames—that is, there will be a $(pipes - 1)$ frames delay between a user input and the corresponding output frame.

Frame multiplexing can also be accelerated in hardware using the SGI Video Digital Multiplexer (DPLEX), which connects pipes together with a bus, thereby avoiding the image readbacks from the contributing pipes. The pipes are daisy-chained to achieve reduced latency. For more details, see Chapter 5, “Using Scalable Graphics Hardware”.

Example 4-5 shows the configuration file specifications for the screen decomposition illustrated in Figure 4-5. The application must support the DPLEX compound.

Example 4-5 DPLEX Compound in a Configuration File

```
compound {
  mode [ DPLEX ]
  channel "channel"

  region {
    channel "dplex::0"
  }

  region {
    channel "dplex::1"
  }

  region {
    channel "dplex::2"
  }
}
```

You can achieve full scalability—that is, scale by the number of pipes rather than by (pipes-1)—using a DPLEX compound. To do so, you must specify the destination channel as a source channel also and the application must support this feature. Example 4-6 shows a configuration file structured for full scalability using the DPLEX compound.

Example 4-6 DPLEX Compound Structured for Full Scalability

```
compound {
  mode [ DPLEX ]
  channel "channel"

  region {
    channel "channel"
  }

  region {
    channel "buffer"
  }
}
```

Note: Full scalability using the DPLEX compound is supported only on InfiniteReality graphics systems.

Data Streaming

Data streaming (also referred to as 3D decomposition) is similar to database decomposition in that it allows the application to divide the scene among multiple pipes and then composite the partial results to give the final rendering. But, in this case, the composition is done using a series of successive compounds for each frame, as shown in Figure 4-6. For frame N+1, channel `stream::1` draws the first quarter of the database, which is copied to channel `stream::2` at the beginning of the next frame. During frame N+2, channel `stream::2` draws the second quarter of the database on top while channel `stream::1` starts a new frame. At frame N+4, the destination channel `channel` finishes drawing the last quarter and displays the frame started three time steps ago.

Like DPLEX decomposition, this scheme also has a latency of $(pipes - 1)$ frames—that is, there will be a $(pipes - 1)$ frames delay between a user input and the corresponding output frame. As shown in Figure 4-6, this latency is due to successive compounds at each frame. You must wait for $(pipes - 1)$ frame computations before the final rendering is displayed. Each compound needs to read only one source image. Consequently, this keeps graphics I/O consumption low while performance scaling is achieved by pipelining the rendering in parallel across the pipes.

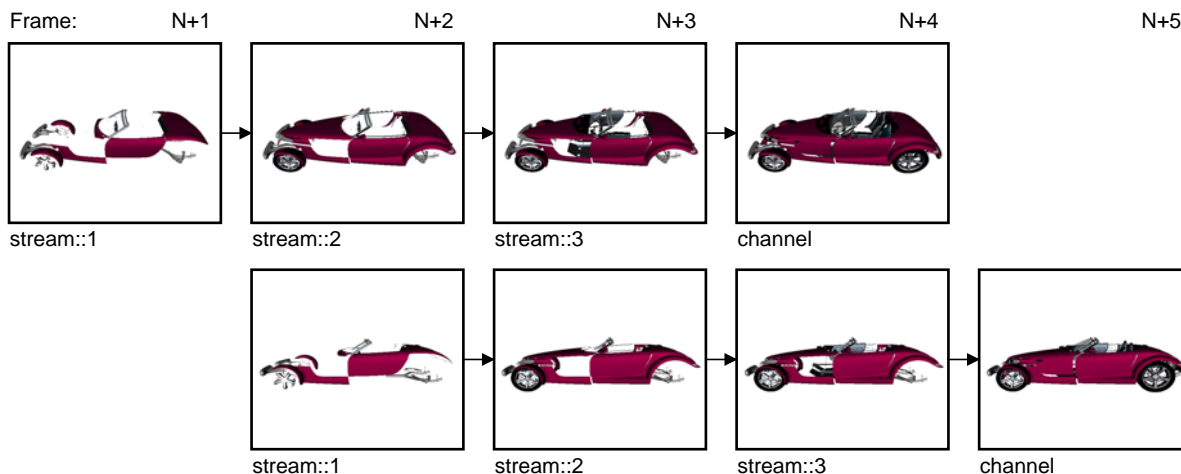

Figure 4-6 Data Streaming Decomposition

As shown in Example 4-7, the configuration file specification for a data streaming decomposition is similar to that for database decomposition.

Example 4-7 Data Streaming Compound (3D) in a Configuration File

```
compound {
  mode      [ 3D ]
  format    [ COLOR DEPTH ]
  channel   "channel"

  region {
    range    [ .0 .25 ]
    channel   "stream:1"
  }

  region {
    range    [ .25 .5 ]
    channel   "stream:2"
  }

  region {
    range    [ .5 .75 ]
    channel   "stream:3"
  }

  region {
    range    [ .75 1. ]
    channel   "channel"
  }
}
```

The application must support the 3D compound.

Pixel-Based Decomposition

In pixel-based decomposition, a frame is rendered using a multipass approach where single passes are assigned to individual source pipes for rendering. Assembling each frame using accumulation techniques constitutes the final rendering. Accumulation of the frames can be achieved using one of the following techniques:

- The SGI Scalable Graphics Compositor
- OpenGL accumulation
- OpenGL blending

In order to use OpenGL accumulation, you must use an appropriate visual; otherwise, MPK uses blending.

Full-Scene Antialiasing (FSAA) Decomposition

MPK has implemented one scheme of pixel-based decomposition, a full-scene antialiasing (FSAA) compound. Each pipe renders the full scene from a slightly different viewpoint. The number of rendering passes of a FSAA compound is defined by its number of sources. Furthermore, every channel can thereby be used multiple times. This type of decomposition is used when the the resulting output quality has highest priority. The scalability and final rendering quality depends on the number of available pipes.

FSAA Compound Examples

Example 4-8 shows an FSAA compound using the SGI Scalable Graphics Compositor:

Example 4-8 Four-Pipe 4x FSAA Compound Using the SGI Graphics Compositor

```
compound {
    mode    [ FSAA HW NOCOPY ]
    channel "channel-0"

    # The number of sources defines the FSAA mode
    region {
        channel "channel-0"
    }
    region {
        channel "channel-1"
    }
    region {
        channel "channel-2"
    }
    region {
        channel "channel-3"
    }
}
```

Figure 4-7 illustrates the advantage of using a 4x FSAA solution.

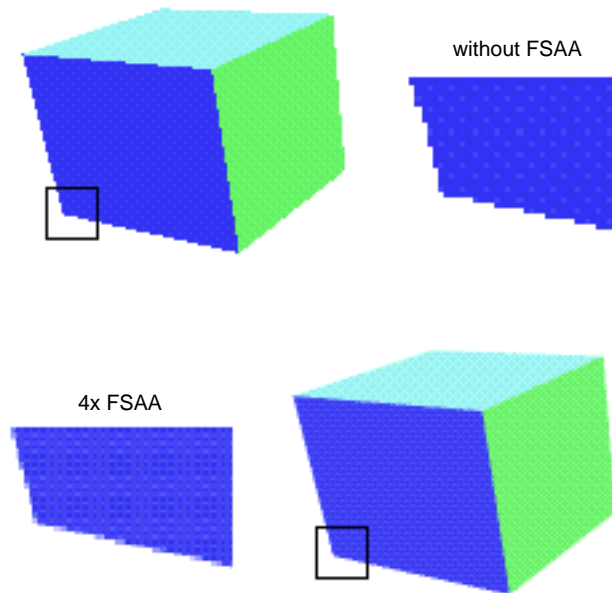

Figure 4-7 4x FSAA Decomposition

Example 4-9 shows how to use the same channel multiple times as a source channel to support multipass rendering in MPK on machines with only a few pipes.

Example 4-9 Multiple Use of a Single Channel in FSAA Decomposition

```
compound {
  mode    [ FSAA ]
  channel "channel"

  # The number of sources defines the FSAA mode
  region {
    channel "channel"
  }
  region {
    channel "channel"
  }
  region {
    channel "channel"
  }
  region {
    channel "channel"
  }
}
```

Cull Decomposition

Cull decomposition is different from the other decomposition modes in that it does not decompose the rendering of a frame. Instead, it decomposes (parallels) the cull and draw operations. Naturally, the use of this feature in the configuration file requires the application also to support the cull decomposition mode.

In cull decomposition, a region specifies the operation to be executed by this region. Example 4-10 shows a cull decomposition for a single channel.

Example 4-10 A Simple Cull Decomposition

```
config
{
  name      "1-window"

  pipe
  {
    window
    {
      name      "MPK: simple"
      viewport  [ 0.25, 0.25, 0.5, 0.5 ]

      channel
      {
        name      "channel"

        wall
        {
          bottom_left  [ -.5, -.4, -1 ]
          bottom_right [  .5, -.4, -1 ]
          top_left     [ -.5,  .4, -1 ]
        }
      }
    }
    window
    {
      attributes { hints { drawable none } }
      channel    { name    "cull" }
    }
  }

  compound
  {
    mode [ CULL ]
    channel "channel"

    region { cull channel "cull" }
    region { draw channel "channel" }
  }
}
```

In this example, the channel `cull` executes the culling concurrently with the draw operation of channel `channel`. It is defined on a window that has no drawables, because it is not used for any draw operation. You can add the `ASYNC` flag to force the cull region to process data for the frame `N`, and the draw region to draw frame `N-1`. This introduces an additional frame of latency, but potentially increases performance.

The `region` operation can be the value `cull`, `draw`, or `cull-draw`. The default operation is `cull-draw`; that is, all source channels first execute the cull operation and then the draw operation.

If multiple regions of a cull compound execute the same operation (cull or draw) for the destination channel, they process the data in parallel and, therefore, may speed up the operation if enough resources are available. As a feature of the MPK implementation, the distribution of the cull and draw tasks is automatically load-balanced. For recomposition, MPK uses by default the same algorithm that is used for DB compounds.

Note: Since culling is application-specific, you must determine (perhaps, from your application vendor) what MPK features and configurations are supported by your application.

It is possible to further decompose the regions of a cull compound, as described in the following section, “Multilevel Decomposition”.

Multilevel Decomposition

MPK allows you to combine the various decomposition schemes to fix performance bottlenecks that differ in nature. For example, a combined solution can use a database and temporal decomposition scheme for optimizing performance (but it will have a limiting transport delay) or can use an eye and database decomposition scheme for stereo volume rendering.

Figure 4-8 shows a four-pipe solution using an eye and database decomposition scheme.

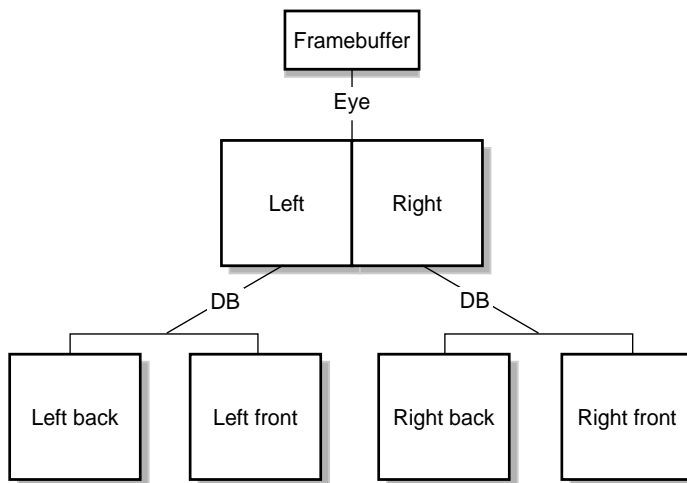

Figure 4-8 Eye-DB Multilevel Decomposition

Example 4-11 shows the configuration file specifications for the multilevel decomposition illustrated in Figure 4-8.

Example 4-11 Multilevel Compound in a Configuration File

```
compound {
  mode [ EYE ]
  channel "right-front"

  region {
    eye LEFT
    compound {
      mode [ DB ]
      channel "left-front"

      region {
        range [ 0., .5 ]
        channel "left-back"
      }

      region {
        range [ .5, 1. ]
        channel "left-front"
      }
    }
  }

  region {
    eye RIGHT
    compound {
      mode [ DB ]
      channel "right-front"

      region {
        range [ 0., .5 ]
        channel "right-back"
      }

      region {
        range [ .5, 1. ]
        channel "right-front"
      }
    }
  }
}
```

Stereo-Selective Compounds

In many instances, it will be desirable to control which compounds will be used by the application based on whether the application is running in stereo mode. MPK provides a mode parameter for this purpose. For instance, if the application is to run in stereo mode, you may want to use eye decomposition and when in mono mode, to use another type of decomposition. Example 4-12 illustrates this conditional use of compounds.

Example 4-12 Stereo-Selective Compounds

```
compound {
  mode    [ EYE STEREO ]
  channel "channel"

  region {
    eye      LEFT
    channel  "buffer"
  }
  region {
    eye      RIGHT
    channel  "channel"
  }
}

compound {
  mode    [ 2D MONO ]
  channel "channel"

  region {
    viewport [ 0., 0., 1., .5 ]
    channel  "buffer"
  }

  region {
    viewport [ 0., .5, 1., .5 ]
    channel  "channel"
  }
}
```

The MONO and STEREO flags allow you to specify different channel decompositions depending on the current configuration mode. This is especially useful for eye decomposition. In this example, when the destination channel is in stereo mode, MPK uses the eye decomposition. When the destination channel is in mono mode, MPK uses the 2D decomposition.

Automatic Load Balancing for Compounds

Achieving an ideal decomposition among the children of a compound can be difficult, since the workload per child often changes on a per-frame basis. To address this problem, MPK provides automatic load balancing for 2D, DB, and 3D compounds.

This section describes the following topics:

- “Dynamic and Static Load Balancing”
- “Proper Environment for Automatic Load Balancing”
- “How to Enable Automatic Load Balancing”
- “Using a Split-Axis Method for Tiling”

Dynamic and Static Load Balancing

Figure 4-9 contrasts dynamic and static load balancing for a 2D compound using `volview`. Volume rendering is bound by fill rate; therefore, the load balancing can adjust the compound's region so that each pipe has approximately the same amount of volume to rasterize. When using static tiling, one pipe may have to render the whole volume as it is moved around. Since the slowest child dictates overall performance, the frame rate is better, in this case, when using load balancing.

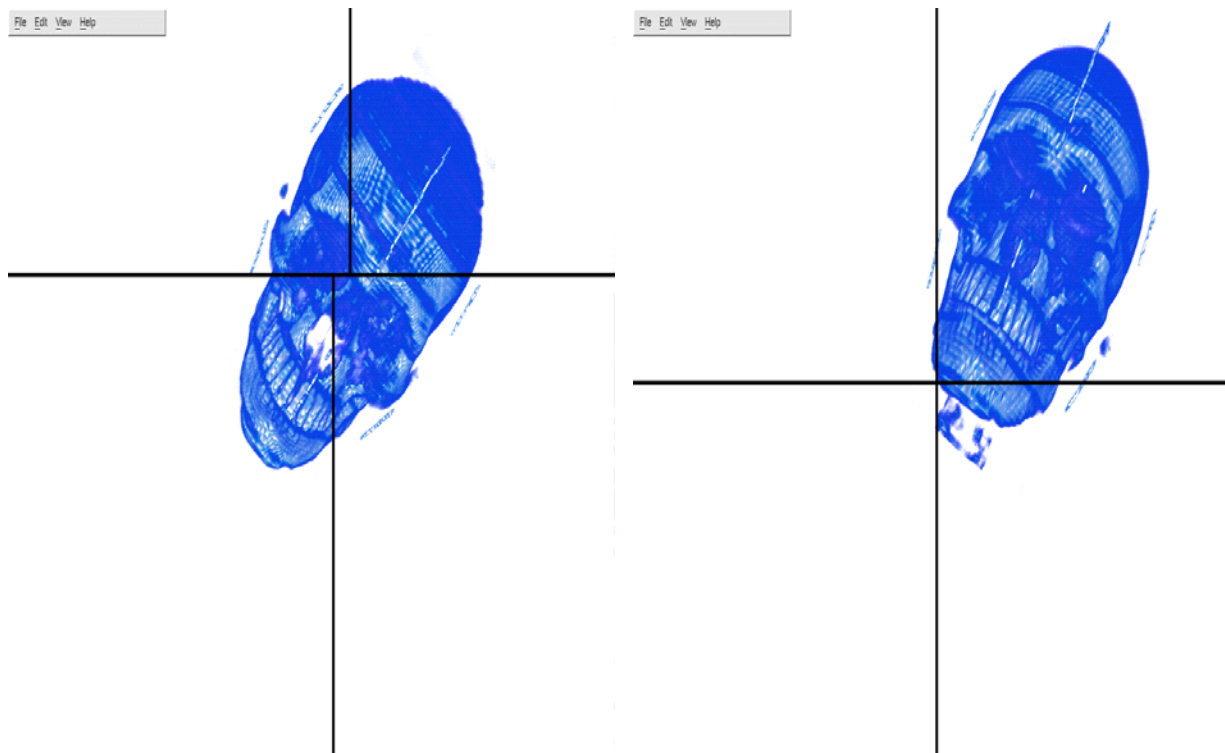

Figure 4-9 Dynamic Versus Static Load Balancing

Proper Environment for Automatic Load Balancing

Using the rendering times for each child, MPK computes a new viewport or range each frame. This approach needs the following conditions to work properly:

Condition	Description
Low latency	A new workload can only be computed after all children have drawn. Therefore, the higher the latency, the higher the difference will be between the frame which is used to compute the new balance and the frame for which the balance is computed. Logically, high latency is counterproductive in achieving proper load balancing.

Frame consistency	Since the new viewport or range is computed based on the last finished frame but applied to the next frame, the two frames should be similar. This is true for most applications.
Scalable compound mode	The chosen decomposition mode has to solve the application's bottleneck. For example, load balancing a 2D compound for a geometry-limited application will fail, unless this application uses view-frustum culling.
Imbalance in decomposition	If the decomposition is already well-balanced—for example, for a DB compound—the static compound may provide a better frame rate.

How to Enable Automatic Load Balancing

In the configuration file, you can use the `ADAPTIVE` mode flag for a compound to enable load balancing. This mode flag can be used for 2D, DB, and 3D compounds. 2D compounds will use tiles, while DB and 3D compounds will adapt the z-axis range to decompose the rendering. The next section describes how you use a split-axis method to determine tiling schemes and z-axis splits.

Note: If you do not provide a tiling scheme (or z-axis split) for `ADAPTIVE` mode, MPK creates one.

Using a Split-Axis Method for Tiling

As the name implies, a split-axis method uses splits on the Cartesian coordinate axes to determine tiling schemes (or z-axis range splits). As noted in the preceding section, the tiling schemes are specific to 2D compounds and z-axis splits, to DB and 3D compounds.

You specify a split in the configuration file by using the `split` field of the `compound` data structure. Chapter 6, “Configuration File Format” describes the formal syntax for the `split` field. This section provides several examples of how to use the field. Example 4-13 shows a tiling scheme for a 2D compound with four regions (source channels) defined.

Example 4-13 2D Tiling Scheme with Four Regions and Horizontal Tiles

```
split "[[1 | 2] - [3 | 4]]"
```

Note the following syntax items and other restrictions:

- The `split` value is a string.
- MPK uses the following operators in the string to denote the axis-specific splits:

| Splits the x axis.

- Splits the y axis.

/ Splits the z axis.

The operators `|` and `-` can be used only with 2D compounds and `/`, only with DB and 3D compounds.

- Integers represent the regions in the compound data structure in the order of declaration. All regions declared in the compound must appear in the `split` string.
- A set of brackets must enclose a split, which can be nested in another split (as shown in Example 4-13).

Figure 4-10 illustrates the tiling scheme specified in Example 4-13.

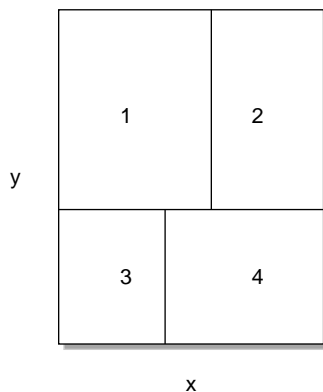

Figure 4-10 2D Tiling Scheme with Four Regions and Horizontal Tiles

Example 4-14, like Example 4-13, shows a tiling scheme for a 2D compound with four regions, but this time the primary split is on the x axis.

Example 4-14 2D Tiling Scheme with Four Regions and Vertical Tiles

```
split "[[1 - 2] | [3 - 4]]"
```

Figure 4-11 illustrates the tiling scheme specified in Example 4-14.

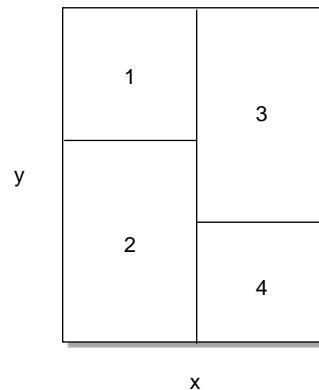

Figure 4-11 2D Tiling Scheme with Four Regions and Vertical Tiles

If you do not specify a split, MPK will automatically create one.

Choosing the Right Decomposition Model

There are no hard and fast rules for choosing the correct decomposition scheme, but the following are some general guidelines to aid you in selecting a reasonable scheme for your environment:

Mode	Recommended Use
2D	Use this scheme if your application is fill-limited. You can also scale geometry performance and texture memory if your application is using view-frustum culling techniques.
3D	Use this scheme where you would normally use the DB scheme but where you experience scalability problems caused by a graphics I/O bottleneck on the destination pipe. For 3D decomposition, the graphics

I/O per pipe is constant when changing the number of contributing pipes. Unlike the DB scheme, however, adding pipes to a 3D compound increases latency.

DB	Use this scheme when your application's frame rendering can be sequenced into equally consuming phases. This requires the application to divide your scene into multiple components and then to composite them correctly. Scalability here can be either on fill, geometry, or graphics resources (texture) depending on the application.
FSAA	Use this scheme if graphics quality is a primary concern.
EYE	Use this scheme for stereo viewing.
DPLEX	Use this scheme for general load balancing where the application maintains a reasonably steady frame rate.

Note: With the DB, 3D, and full-scale DPLEX modes, the application must support the feature.

These are very high-level guidelines that may very well overlap. As noted in the section "Multilevel Decomposition" on page 49, you can combine the various decomposition modes to fix different performance bottlenecks.

Using Scalable Graphics Hardware

In contrast to most of the compounds described in Chapter 4, “Compounds”, scalable graphics hardware offers a hardware solution to joining or cascading the video output of two or more graphics pipes and outputting them in a single video output. Scalable graphics hardware provides nearly perfect scaling of both geometry rate and fill rate on some applications.

This chapter describes how you use MPK in conjunction with an SGI Video Digital Multiplexer (DPLEX) and an SGI Scalable Graphics Compositor in the following sections:

- “Using MPK with a DPLEX”
- “Using MPK with an SGI Scalable Graphics Compositor”

Using MPK with a DPLEX

A DPLEX is an optional daughtercard that permits multiple graphics hardware pipelines to work simultaneously on a single visual application. DPLEX hardware is available on Silicon Graphics Onyx2, SGI Onyx 3000, and SGI Onyx 300 systems. This section describes how you create the DPLEX compound in MPK and shows a configuration file example. For an overview of the DPLEX hardware, see the document *Onyx2 DPLEX Option Hardware User's Guide*.

To enable DPLEX decomposition, you must specify the DPLEX mode along with the HW flag in the configuration file. The destination channel's pipe is used to control the hyperpipe. Naturally, this is the display pipe of the DPLEX cascade. The use of the NOCOPY flag is mandatory to suppress pixel transfer.

Example 5-1 shows a three-pipe DPLEX cascade with the pipe associated to channel `channel1 : : 1` being the display pipe. The order of the channels reflects the order of the pipes in the DPLEX cascade.

Example 5-1 A Typical DPLEX Compound

```
compound {
  mode [ DPLEX HW NOCOPY ]
  channel "channel::1"

  region {
    channel "channel::1"
  }

  region {
    channel "channel::2"
  }

  region {
    channel "channel::3"
  }
}
```

Using MPK with an SGI Scalable Graphics Compositor

This section gives a brief overview of the SGI Scalable Graphics Compositor and how to use it with MPK. For more information on the compositor, including the details of the hardware setup, refer to the document *SGI InfinitePerformance: Scalable Graphics Compositor User's Guide*.

Note: The compositor is currently supported by InfinitePerformance graphics systems only.

General Capabilities

The compositor can perform spatial compositions, pixel averaging, and stereo rendering. The compositor receives two to four input signals and outputs a single signal either in analog or digital format.

The following items are noteworthy regarding the compositor's capabilities:

- For every output pixel, the compositor averages all values from all the pipes. Among other things, this provides applications with the means to do full-scene antialiasing (FSAA) in hardware.
- Stereo is supported only for analog output.
- Due to restrictions imposed by the compositor, MPK does not allow the mixing of the various hardware decomposition modes—for example, two vertical stripes with two horizontal stripes.

Note: For more information on the current limitations and anomalies associated with the use of the SGI Scalable Graphics Compositor, refer to the hardware documentation.

Hardware Spatial Composition Schemes

Because the compositor receives two to four input signals and outputs a single signal either in analog or digital format, it can handle spatial composition of four inputs. This enables multiple pipes to contribute to a single output. Four different spatial composition schemes are available:

- Vertical stripes
- Horizontal stripes
- 2D tiles
- Cut-ins

Figure 5-1 illustrates the various hardware composition schemes.

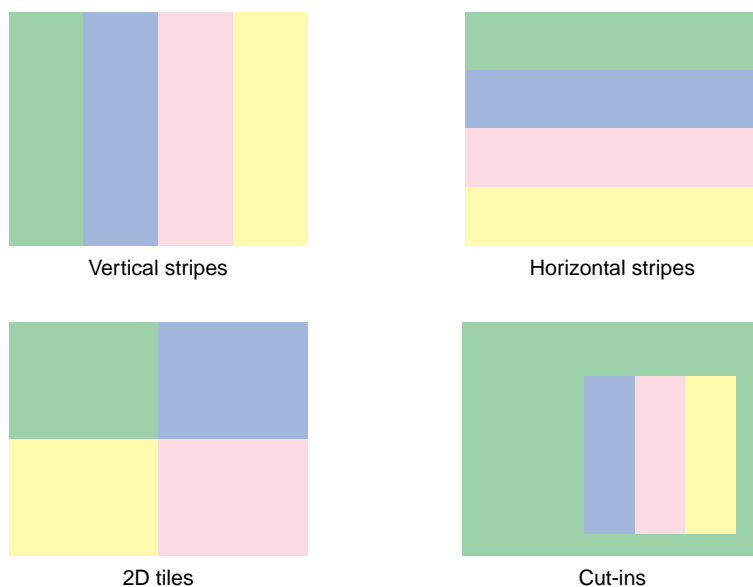

Figure 5-1 Hardware Spatial Composition Schemes

MPK Specifications

In order to use the compositor with MPK, you must specify the 2D, EYE, or FSAA compound mode along with the HW flag. If you do not specify the NOCOPY flag, copying is performed even though the compositor is being used. Example 4-8 on page 45 shows a configuration file entry for an FSAA compound using the SGI Scalable Graphics Compositor.

Example 5-2 shows how a 2 x 2 tiling scheme might look in a configuration file.

Example 5-2 A 2 x 2 Tiling Scheme in a Configuration File

```

compound {
  mode      [ 2D HW NOCOPY ]
  channel   "channel0"

  region {
    viewport [ 0., 0.5, .5, .5 ]
    channel  "channel0"
  }
  region {
    viewport [ 0.5, 0.5, .5, .5 ]
    channel  "channel1"
  }

  region {
    viewport [ 0., 0., .5, .5 ]
    channel  "channel2"
  }

  region {
    viewport [ .5, 0., .5, .5 ]
    channel  "channel3"
  }
}

```

Note the following:

- You must specify a destination channel if the compositor is to be used. Otherwise, MPK uses a software fallback solution.
- MPK does not require that the destination channel be used as a source channel—that is, it does not have to contribute to the rendering.

To use the Xinerama full-window overlapping feature, specify the `display` subfield in the `compound` data structure. This field specifies the X11 display name to be used for setting up the `glXHyperpipe` when using Xinerama and an SGI Scalable Graphics Compositor. To use this feature, you must first switch to a proper Xinerama `Xsgi` configuration. Example 5-3 shows a sample `compound` specification.

Example 5-3 Using the Xinerama Full-Window Overlapping Feature

```
compound {
    mode [2D HW NOCOPY]

    region {
        display ":0.0"
        viewport [0.0, 0.5, 0.5, 0.5]
    }
    region {
        display ":0.1"
        viewport [0.5, 0.5, 0.5, 0.5]
    }
    region {
        display ":0.2"
        viewport [0.0, 0.0, 0.5, 0.5]
    }
    region {
        display ":0.3"
        viewport [0.5, 0.0, 0.5, 0.5]
    }
}
```

When Xinerama is used to overlap screen regions on an edge-blended display or compositor-based system, the cursor will seem to disappear when it enters the overlapped or uncomposited regions of the display.

By upgrading to IRIX 6.5.20 or later, you can use an X server feature that prevents the cursor from disappearing in these cases. It causes additional cursor images (not real cursors) to appear on all pipes contributing to the overlapped regions. To enable this feature, add the `-phantomcursors` flag to the X server command line in the `/var/X11/xdm/Xservers` file.

For more information about the `-phantomcursors` option, see the `Xsgi(1)` man page.

Configuration File Format

This chapter contains the following topics:

- “File Format”
- “Defining MPK Data Structures”
- “Specifying Global Attributes”

File Format

This section describes the format you must use to create an MPK configuration file. The format of the configuration file closely follows the conventions for the Open Inventor file format. The following items are described:

- “Specifying Comments (#)”
- “Specifying Delimiters”
- “Specifying MPK Data Structures”
- “Specifying Values within a Field”

Specifying Comments (#)

MPK considers any items between a number sign (#) and the end of the line to be a comment. The number sign can be anywhere on the line.

Specifying Delimiters

White space delimits most elements in the configuration file—for example, a field name and its value. Exceptions are noted where they apply. Extra white space created by spaces, tabs, and new lines is ignored.

Specifying MPK Data Structures

An MPK data structure consists of the following sequence of elements:

1. Data structure type (`config`, `pipe`, `window`, `channel`, or `compound`)
2. Open brace (`{`)
3. Field specifications (if any), followed by child structures (if any)
4. Close brace (`}`)

The following lines show the syntax symbolically:

```
data-structure-type {  
    field-specs  
    child-specs  
}
```

The following is an example of a `channel` data structure:

```
channel {  
    viewport          [ 0., 0., 1., 1. ]  
    projection {  
        origin        [ 0., 0., 0. ]  
        distance      3.  
        fov           [ 54., 47. ]  
        hpr           [ 0., 0., 0. ]  
    }  
}
```

The later section “Defining MPK Data Structures” on page 68 describes the special requirements for defining each of the data structures.

Specifying Values within a Field

There are three types of MPK fields:

- Single-value fields

These fields have the following syntax:

name value

- Multiple-value fields

These fields have the following syntax:

name [value1, value2, . . . valuen]

- Composite fields

These fields have the following syntax:

```
name {
    subfields-specs
}
```

The fields can appear in any order.

The values you specify in a field are determined by the field type. The field types and accepted formats are described in Table 6-1.

Table 6-1 Field Types and Formats

Field Type	Accepted Format
int	Use an integer in decimal, hexadecimal, or octal format. Examples: 55 0xff 0177
float	Use an integer or floating point number. Examples: 10 10. 10.3 1.3e-2

Table 6-1 Field Types and Formats (**continued**)

Field Type	Accepted Format
string	Use double quotation marks (“ ”) around the value. Example: name “3-pipes”
enum	Use a mnemonic. Examples: true-color direct-color
boolean	Use a mnemonic (y or n) or an integer (0 or 1).

Defining MPK Data Structures

The earlier section “Specifying MPK Data Structures” on page 66 describes the general format of an MPK data structure as follows:

```
data-structure-type {  
    field-specs  
    child-specs  
}
```

This section describes the field specifications and child specifications required to define the following MPK data structures:

- config
- pipe
- window
- channel
- compound

Additionally, you can include a `global` data structure to define defaults for global attributes. The later section “Specifying Global Attributes” on page 87 describes how you do so.

The `config` Data Structure

The `config` data structure encapsulates the other data structures and as such defines the overall configuration. It has the following form:

```
config {
    name      "config-name"
    mode      stereo-mono
    mono      "shell command1"
    stereo    "shell command2"
    runon     processor-spec
    pipe-1-specs
    pipe-2-specs
    .
    .
    .
    pipe-n-specs
    compound-specs
}
```

Every `config` data structure requires a `pipe` data entry for each pipe you want to use in your system. Section “The pipe Data Structure” on page 70 describes the *pipe-i-specs* fields, section “The compound Data Structure” on page 83 describes the *compound-specs* field, and Table 6-2 describes the other `config` fields.

Table 6-2 The `config` Fields

Field	Description
<code>name</code>	The name field is a string identifier for the current configuration.
<code>mode</code>	The mode field characterizes the initial configuration state: either <code>mono</code> or <code>stereo</code> .

Table 6-2 The config Fields (continued)

Field	Description
mono stereo	These fields describe the shell command to execute when changing to mono or stereo mode. By default, no command is executed.
runon	If the runon field contains a processor ID, that processor becomes the default processor for all configuration threads—that is, the processor to which every window thread will be assigned, unless specified otherwise by the window runon field. A runon value of -1 means the thread is bound to a processor according to the default run-on policy. If the value is set to <code>auto</code> , MPK will bind the window thread to a processor on the node for this pipe, if possible. If the value is set to <code>free</code> , the operating system decides on what processor to execute the thread. The default is -1.

The pipe Data Structure

A pipe data structure has the following form:

```
pipe {
  name      "pipe-name"
  display   "display-name"
  attributes {
    mono {
      width  w
      height h
    }
    stereo {
      type    stereo-type
      width  w
      height h
      offset  0
    }
  }
  window-spe
}
```

Every pipe data structure must contain a window entry. The section “The window Data Structure” on page 72 describes the *window-specs* field. Table 6-3 describes the other fields of a pipe data structure.

Table 6-3 The pipe Fields

Field	Description
name	The name field is a string identifier for the current pipe.
display	The display field specifies the name of the X display for the current pipe.
attributes	<p>The attributes field is a composite field with the following subfields:</p> <p>mono</p> <p>stereo</p> <p>These subfields are in turn composite fields. The subfield mono has the following fields:</p> <p>width <i>w</i></p> <p>height <i>h</i></p> <p>The values for <i>w</i> and <i>h</i> must be integers. The subfield stereo has the following fields:</p> <p>type <i>stereo-type</i></p> <p>width <i>w</i></p> <p>height <i>h</i></p> <p>offset <i>o</i></p> <p>The values for <i>w</i>, <i>o</i>, and <i>h</i> must be integers. The value for <i>stereo-type</i> can be one of the following:</p> <p>quad</p> <p>rect</p> <p>top</p> <p>bottom</p> <p>user</p> <p>If no stereo type is specified, quad is used.</p>

Example 6-1 is an example of a pipe definition:

Example 6-1 A Sample pipe Definition

```
pipe {
  display      ":0.0"
  window {
    runon      2
    viewport   [ 0., 0., 1., 1. ]
    channel {
      viewport [ 0., 0., 1., 1. ]
      projection {
        origin [ 0., 0., 0. ]
        distance 3.
        fov [ 54., 47. ]
        hpr [ 0., 0., 0. ]
      }
    }
  }
}
```

The window Data Structure

A window data structure has the following form:

```
window {
  name      "win-name"
  viewport [ x, y, width, height ]
  runon     processor-spec
  attributes attribute-specs
            channel-specs
}
```

Every window data structure requires a `channel` entry. The section “The channel Data Structure” on page 78 describes the *channel-specs* field. Table 6-4 describes the other fields of a window data structure.

Table 6-4 The window Fields

Field	Description
<code>name</code>	The name field is a string identifier for the current window.
<code>viewport</code>	<p>The <code>viewport</code> field specifies the fractional viewport (position and size) of the current window relative to the display dimensions. The fractional viewport format is [<i>x, y, width, height</i>] with all parameters in the range 0.0 to 1.0.</p> <p>See the section “Specifying Global Attributes” on page 87 for more information on the following related global variables:</p> <p><code>MPK_PATTR_MONO_HEIGHT</code> <code>MPK_PATTR_MONO_WIDTH</code> <code>MPK_PATTR_STEREO_HEIGHT</code> <code>MPK_PATTR_STEREO_OFFSET</code> <code>MPK_PATTR_STEREO_TYPE</code> <code>MPK_PATTR_STEREO_WIDTH</code></p>
<code>runon</code>	<p>If the <code>runon</code> field contains a processor ID, that processor will be the default processor for the current window thread—that is, the processor to which the window thread will be assigned. A <code>runon</code> value of -1 means the thread is bound to a processor according to the default run-on policy. If the value is set to <code>auto</code>, then MPK will bind the window thread to a processor on the node for this pipe, if possible. If the value is set to <code>free</code>, then the operating system decides on what processor to execute the thread. The default is -1.</p>
<code>attributes</code>	<p>The <code>attributes</code> field specifies the X Window System default visual attributes and other related information, such as whether window managers decorations should be present or not.</p> <p>The <code>attributes</code> field is a composite field with the following subfields:</p> <p><code>hints</code> <code>planes</code> <code>transparent</code></p> <p>These subfields are in turn composite fields, which are described in the tables that follow.</p>

Table 6-5 describes the structure and values of the `hints` subfields.

Table 6-5 Window Attributes—`hints` Subfields

Subfield	Valid Values	Description
<code>visual</code>	<code>true-color</code> <code>pseudo-color</code> <code>direct-color</code> <code>static-color</code> <code>grayscale</code> <code>static-gray</code>	Specifies the type of GLX visual to be used. Related global variable: <code>MPK_WATTR_HINTS_VISUAL</code>
<code>caveat</code>	<code>none</code> <code>slow</code> <code>non-conformant</code>	Specifies a caveat for selecting the framebuffer, such as one of the following: <code>MPK_GLX_SLOW</code> <code>MPK_GLX_NON_CONFORMANT</code> <code>MPK_GLX_NOCAVEAT</code> Related global variable: <code>MPK_WATTR_HINTS_CAVEAT</code>
<code>transparent</code>	<code>y</code> or <code>n</code>	Determines if a visual should be opaque or transparent. Related global variable: <code>MPK_WATTR_HINTS_TRANSPARENT</code>
<code>X-renderable</code>	<code>y</code> or <code>n</code>	Determines which visuals are selected. If true, only visuals which have an associated X visual are selected. Related global variable: <code>MPK_WATTR_HINTS_X_RENDERABLE</code>
<code>rgba</code>	<code>y</code> or <code>n</code>	Specifies if an RGBA or color-index visual is selected. Related global variable: <code>MPK_WATTR_HINTS_RGBA</code>
<code>doublebuffer</code>	<code>y</code> or <code>n</code>	Specifies if a double- or single-buffer visual is selected. Related global variable: <code>MPK_WATTR_HINTS_DOUBLEBUFFER</code>

Table 6-5 Window Attributes— `hints` Subfields (**continued**)

Subfield	Valid Values	Description
<code>stereo</code>	<code>y</code> or <code>n</code>	Specifies if a stereo-capable visual is selected Related global variable: <code>MPK_WATTR_HINTS_STEREO</code>
<code>drawable</code>	<code>window</code> <code>pbuffer</code> <code>pixmap</code> <code>none</code>	Specifies the type of drawable to be used for rendering. For the value <code>none</code> , MPK executes no draw operation. Related global variable: <code>MPK_WATTR_HINTS_DRAWABLE</code>
<code>direct</code>	<code>y</code> or <code>n</code>	Specifies if a direct or indirect context is created. Related global variable: <code>MPK_WATTR_HINTS_DIRECT</code>
<code>largest</code>	<code>y</code> or <code>n</code>	Determines whether the largest available <code>pbuffer</code> is allocated. It will be if a <code>pbuffer</code> <code>drawable</code> is used and this flag is set. Related global variable: <code>MPK_WATTR_HINTS_LARGEST</code>
<code>preserved</code>	<code>y</code> or <code>n</code>	Determines whether the content of the framebuffer is preserved. It will be if a <code>pbuffer</code> <code>drawable</code> is used and this flag is set. Related global variable: <code>MPK_WATTR_HINTS_PRESERVED</code>
<code>decoration</code>	<code>y</code> or <code>n</code>	Determines if the window should have window manager decorations. Related global variable: <code>MPK_WATTR_HINTS_DECORATION</code>
<code>xinerama</code>	<code>y</code> or <code>n</code>	Indicates that this window are created using Xinerama if <code>xinerama</code> is <code>y</code> . If it is set to <code>n</code> , the window is created Xinerama-aware. Related global variables: <code>MPK_WATTR_HINTS_XINERAMA</code> <code>MPK_XINERAMA</code>

Table 6-6 describes the structure and values of the `planes` subfields. In all instances in this table, the variables denote integers.

Table 6-6 Window Attributes—`planes` Subfields

Subfield	Valid Values	Description
<code>level</code>	x	Specifies the buffer level. Positive values correspond to overlay buffers and negative values correspond to underlay buffers. Related global variable: <code>MPK_WATTR_PLANES_LEVEL</code>
<code>depth</code>	x	Specifies the minimum depth buffer size. Related global variable: <code>MPK_WATTR_PLANES_DEPTH</code>
<code>stencil</code>	x	Specifies the minimum stencil buffer size. Related global variable: <code>MPK_WATTR_PLANES_STENCIL</code>
<code>samples</code>	x	Specifies the minimum number of multi-sample buffers. Related global variable: <code>MPK_WATTR_PLANES_SAMPLES</code>
<code>auxiliary</code>	x	Specifies the minimum number of auxiliary buffers. Related global variable: <code>MPK_WATTR_PLANES_AUX</code>
<code>color</code>	x	Specifies the minimum color-index buffer size. Related global variable: <code>MPK_WATTR_PLANES_COLOR</code>

Table 6-6 Window Attributes—planes Subfields (**continued**)

Subfield	Valid Values	Description
rgba	$[r, g, b, a]$	Specifies the minimum RGBA buffer size. Related global variables: MPK_WATTR_PLANES_RED MPK_WATTR_PLANES_GREEN MPK_WATTR_PLANES_BLUE MPK_WATTR_PLANES_ALPHA
accum	$[r, g, b, a]$	Specifies the minimum RGBA accumulation buffer size. Related global variables: MPK_WATTR_PLANES_ACCUM_RED MPK_WATTR_PLANES_ACCUM_GREEN MPK_WATTR_PLANES_ACCUM_BLUE MPK_WATTR_PLANES_ACCUM_ALPHA

Table 6-7 describes the structure and values of the transparent subfields. In all instances in this table, the variables denote integers.

Table 6-7 Window Attributes—transparent Subfields

Subfield	Valid Values	Description
index	x	Specifies the index value for the transparent <i>color</i> . Related global variables: MPK_WATTR_TRANSPARENT_INDEX
rgba	$[r, g, b, a]$	Specifies the RGBA value for the transparent <i>color</i> . Related global variables: MPK_WATTR_TRANSPARENT_RED MPK_WATTR_TRANSPARENT_GREEN MPK_WATTR_TRANSPARENT_BLUE MPK_WATTR_TRANSPARENT_ALPHA

The channel Data Structure

A channel data structure has the following form:

```
channel {
    name      "channel-name"
    viewport  [x,y, width, height]
    ortho-wall  ortho-wall-specs
    wall      wall-specs
    projection projection-specs
    channel-attrs
}
```

In the context of framebuffer resources, the channel data structure is conceptually the lowest level in the config-pipe-window-channel hierarchy. Functionally, however, the channel data structure has a child, attributes, shown as *channel-attrs* in the preceding syntax description. The attributes data structure has the following syntax:

```
attributes {
    read {
        depth {
            format  GL-format-enum
            type    GL-type-enum
        }
        color {
            format  GL-format-enum
            type    GL-type-enum
        }
        stencil {
            format  GL-format-enum
            type    GL-type-enum
        }
    }
}
```

Table 6-8 describes the fields of a channel data structure.

Table 6-8 The channel Fields

Field	Description
name	The name field is a string identifier for the current channel. You must specify the name field if your configuration file contains a compound that references this channel.
viewport	The viewport field specifies the fractional viewport (position and size) of the channel relative to the parent window dimensions. The fractional viewport format is [<i>x, y, width, height</i>] with all parameters in the range 0.0 to 1.0.
wall	<p>The wall field contains the modeling coordinates of the bottom-left, bottom-right, and top-left corners of the channel's projection rectangle in the real world.</p> <p>This field is a composite field with the following subfields:</p> <pre>bottom_left [x, y, z] bottom_right [x, y, z] top_left [x, y, z]</pre> <p>See Example 3-1 on page 23 for an example of specifying the wall field.</p> <p>You must specify one of the modeling coordinates fields: wall, projection, or ortho-wall. MPK uses the last specified modeling transformation—that is, either wall or projection—unless you set the channel to orthographic projection by specifying the ortho-wall field.</p>

Table 6-8 The channel Fields (**continued**)

Field	Description
<code>ortho-wall</code>	<p>The <code>ortho-wall</code> field contains an alternate wall description that, if specified, will be used when the channel orthographic frustum is applied.</p> <p>The format for the field values is the same as that of the <code>wall</code> field.</p> <p>You must specify one of the modeling coordinates fields: <code>wall</code>, <code>projection</code>, or <code>ortho-wall</code>. MPK uses the last specified modeling transformation—that is, either <code>wall</code> or <code>projection</code>—unless you set the channel to orthographic projection by specifying the <code>ortho-wall</code> field.</p>
<code>projection</code>	<p>The <code>projection</code> field contains the modeling coordinates and characteristics of an imaginary projection system that would produce the channel's projection rectangle.</p> <p>This is a composite field with the following subfields:</p> <pre> origin [x, y, z] distance d fov [a, b] hpr [h, p, r] </pre> <p>The <code>hpr</code> field represents the head, pitch, and roll and describes Euler angles with respect to the OpenGL convention—that is, the counter-clockwise rotation around the Y axis (head), X axis (pitch), and Z axis (roll) viewed from the positive side of the axis. See Example 3-2 on page 25 for an example of specifying the <code>projection</code> field.</p> <p>You must specify one of the modeling coordinates fields: <code>wall</code>, <code>projection</code>, or <code>ortho-wall</code>. MPK uses the last specified modeling transformation—that is, either <code>wall</code> or <code>projection</code>—unless you set the channel to orthographic projection by specifying the <code>ortho-wall</code> field.</p>
<code>channel-attrs</code>	<p>The <code>channel-attrs</code> field is itself a data structure, attributes, with a single <code>read</code> field. The <code>read</code> field has subfields, which are described in Table 6-9.</p>

Table 6-9 describes the subfields of `read`, which is the single field for the `attributes` data structure.

Table 6-9 Channel Attributes—`read` Subfields

Primary Subfield	Secondary Subfield	Valid Values	Description
<code>color</code>			
	<code>format</code>	Any GL format enum	Defines the color format to be used by this channel when reading color images. The default value is <code>GL_RGB</code> . See the <code>glReadPixels</code> man page for a list of supported values.
	<code>type</code>	Any GL type enum	Defines the color type to be used by this channel when reading color images. The default value is <code>GL_UNSIGNED_BYTE</code> . See the <code>glReadPixels</code> man page for a list of supported values.
<code>depth</code>			
	<code>format</code>	Any GL format enum	Defines the depth format to be used by this channel when reading color images. The default value is <code>GL_DEPTH_COMPONENT24_SGIX</code> on VPro, or else <code>GL_DEPTH_COMPONENT</code> . See the <code>glReadPixels</code> man page for a list of supported values.
	<code>type</code>	Any GL type enum	Defines the depth type to be used by this channel when reading color images. The default value is <code>GL_UNSIGNED_INT</code> on VPro, or else <code>GL_FLOAT</code> . See the <code>glReadPixels</code> man page for a list of supported values.

Table 6-9 Channel Attributes—*read* Subfields (**continued**)

Primary Subfield	Secondary Subfield	Valid Values	Description
<i>stencil</i>			
	<i>format</i>	Any GL format enum	Defines the stencil format to be used by this channel when reading color images. The default value is <code>GL_STENCIL_INDEX</code> . See the <code>glReadPixels</code> man page for a list of supported values.
	<i>type</i>	Any GL type enum	Defines the stencil type to be used by this channel when reading color images. The default value is <code>GL_UNSIGNED_BYTE</code> . See the <code>glReadPixels</code> man page for a list of supported values.

The compound Data Structure

A compound data structure is not a part of the `pipe-window-channel` hierarchy. The compound data structure is subordinate only to the `config` or another compound data structure.

A compound data structure has the following form:

```
compound {
    name          "compound-name"
    channel       "channel-name"
    mode          [ mode flags ]
    format        [ format1 format2 ... formatn ]
    split         "splitString"
    region        region-specs
}
```

Table 6-10 describes the fields of a compound data structure.

Table 6-10 The compound Fields

Field	Description
<code>name</code>	The <code>name</code> field is a string identifier for the current compound.
<code>channel</code>	<p>The <code>channel</code> field identifies the destination channel for the compound. You must specify the name as defined in the <code>name</code> field of the associated <code>channel</code> data structure. If you do not specify this field and the compound has a parent, then its value is inherited from the parent. If the resulting channel is still unspecified, then the compound will simply maintain time consistency of the views across all of its regions with respect to their respective frame latency.</p> <p>Once a channel is involved in a compound, you must explicitly specify any other use of that channel with another compound. This is true also for mode-selective compounds.</p>

Table 6-10 The compound Fields (**continued**)

Field	Description
mode	<p>The mode field specifies the decomposition mode (2D, 3D, CULL, DB, DPLEX, EYE, FSAA, or HMD) and optionally mode flags (ADAPTIVE, ASYNC, HW, MONO, NOCOPY, or STEREO). The following are examples:</p> <pre> mode [3D] mode [DB MONO] mode [EYE STEREO ASYNC] mode [2D ASYNC] mode [DPLEX NOCOPY] </pre> <p>For descriptions of the decomposition modes, see section “Building Compounds” in Chapter 4.</p> <p>For the use of 2D, FSAA, HW, DPLEX, and NOCOPY in scalable hardware solutions, see Chapter 5, “Using Scalable Graphics Hardware”.</p> <p>For the use of ADAPTIVE, see section “Automatic Load Balancing for Compounds” in Chapter 4.</p> <p>ASYNC indicates that the pixel transfer from the regions to the destination channel should be delayed to the next frame. Despite an additional one-frame latency, this setting may have a noticeable influence on the compound performance—especially for 2D and DB decompositions.</p> <p>MONO or STEREO indicates that the decomposition should only be activated when the configuration is in the corresponding stereo mode. Note that a window containing only STEREO-active channels will simply not be launched when the configuration is in MONO mode.</p> <p>NOCOPY indicates that no pixel transfer should occur between the compound and its regions; this is typically useful when you use hardware video compositing equipment—for example, SGI Video Digital Multiplexer (DPLEX).</p>

Table 6-10 The compound Fields (**continued**)

Field	Description
<code>format</code>	<p>The <code>format</code> field specifies the format of the pixel data that has to be transferred between the compound and its regions as a combination of <code>COLOR</code>, <code>DEPTH</code>, and <code>STENCIL</code>. It will be inherited by the compound regions. The following are the possible combinations:</p> <pre>format [COLOR] # default format [COLOR DEPTH] format [COLOR DEPTH STENCIL]</pre>

Table 6-10 The compound Fields (**continued**)

Field	Description
<code>split</code>	<p>The <code>split</code> field specifies the tiling scheme (or z-axis split) used when the compound is used in <code>ADAPTIVE</code> mode. The <code>split</code> value is a string, as shown in the following example:</p> <pre>split "[[1 2] - [3 4]]"</pre> <p>The numbers 1, 2, 3, and 4 represent the regions in the compound (source channels). These numbers map the regions declared in the <code>compound</code> data structure in the order of declaration. All the regions declared in the <code>compound</code> data structure must be included into the <code>split</code> string.</p> <p>The axis that is split is represented by the following operators:</p> <ul style="list-style-type: none"> axis x - axis y / axis z <p>The <code>split</code> operators and - can be used only with 2D compounds and the operator /, only with 3D or DB compounds.</p> <p>The formal syntax of the <code>split</code> field is following:</p> <pre>split "splitString" splitString :[group axis group] group :region splitString axis :' ' '-' '/' region :[integer]</pre> <p>For the use of the <code>ADAPTIVE</code> mode and examples of tiling schemes, see the section "Automatic Load Balancing for Compounds" on page 53.</p>

Table 6-10 The compound Fields **(continued)**

Field	Description
region	<p>The <code>region</code> field specifies a portion of the compound destination channel and the channel where this portion should be rendered. Depending on the compound mode field, the portion described can be either a sub-viewport of the destination channel [2D], a portion of the application database [DB or 3D], a specific eye view [EYE or HMD], a pipelined, de-multiplexed rendering cycle [DPLEX], or the operation to be executed [CULL]. The format for each follows:</p> <p>2D:</p> <pre>viewport [x, y ,width, height] channel "channel-name"</pre> <p>2D HW NOCOPY:</p> <pre>display "display-name" viewport [x, y ,width, height]</pre> <p>CULL:</p> <pre>[cull draw cull-draw]</pre> <p>DB or 3D:</p> <pre>range [a ,b] channel "channel-name"</pre> <p>EYE</p> <pre>eye left-right channel "channel-name"</pre> <p>HMD</p> <pre>eye left-right channel "channel-name"</pre> <p>DPLEX</p> <pre>channel "channel-name"</pre>

See Chapter 4, "Compounds" for examples of compound definitions.

Specifying Global Attributes

A global data structure allows you to specify default values for MPK attributes:

- Stereo and pipe display attributes

- Window attributes
- Channel attributes

To specify a default value for an attribute in the configuration file, use the following construct:

```
global {
    attribute1 value
    attribute2 value
    .
    .
    .
    attributen value
}
```

Your default declarations should precede the definition of the `config` data structure in the configuration file. The following is an example of default declarations:

```
global {
    MPK_DEFAULT_EYE_OFFSET .035
    MPK_WATTR_PLANES_ALPHA 1
}
```

Table 6-11 provides the data type, default value, and description for the MPK global attributes.

Table 6-11 MPK Global Attributes

Variable	Data Type	Default Value	Description
MPK_CATTR_FAR	float	100.	Specifies the default far distance of the channel. This value is preempted by the function mpkChannelSetNearFar() .
MPK_CATTR_NEAR	float	0.01	Specifies the default near distance of the channel. This value is preempted by the function mpkChannelSetNearFar() .
MPK_CATTR_READ_COLOR_FORMAT	Any GL format enum	GL_RGB	Defines the default color format to be used by this channel when reading color images. See the <code>glReadPixels</code> man page for a list of supported values.

Table 6-11 MPK Global Attributes (**continued**)

Variable	Data Type	Default Value	Description
MPK_CATTR_READ_COLOR_TYPE	Any GL format enum	GL_UNSIGNED_BYTE	Defines the default color type to be used by this channel when reading color images. See the <code>glReadPixels</code> man page for a list of supported values.
MPK_CATTR_READ_DEPTH_FORMAT	Any GL format enum	GL_DEPTH_COMPONENT24_SGIX on VPro, else GL_DEPTH_COMPONENT	Defines the default depth format to be used by this channel when reading color images. See the <code>glReadPixels</code> man page for a list of supported values.
MPK_CATTR_READ_DEPTH_TYPE	Any GL format enum	GL_UNSIGNED_INT on VPro, else GL_FLOAT	Defines the default depth type to be used by this channel when reading color images. See the <code>glReadPixels</code> man page for a list of supported values.
MPK_CATTR_READ_STENCIL_FORMAT	Any GL format enum	GL_STENCIL_INDEX	Defines the default stencil format to be used by this channel when reading color images. See the <code>glReadPixels</code> man page for a list of supported values.
MPK_CATTR_READ_STENCIL_TYPE	Any GL format enum		Defines the default stencil type to be used by this channel when reading color images. The default value is <code>GL_UNSIGNED_BYTE</code> . See the <code>glReadPixels</code> man page for a list of supported values.
MPK_CHANNEL_PASS_CACHE_SIZE	int	50	Specifies the cache size for the frame data queues used for culling. This attribute affects the granularity and performance of the data processing for data passed using <code>mpkChannelPassData()</code> .

Table 6-11 MPK Global Attributes (**continued**)

Variable	Data Type	Default Value	Description
MPK_CHANNEL_PUT_CACHE_SIZE	int	10	Specifies the cache size for the cull data queues. This attribute affects the granularity and performance of the data processing for data passed using mpkChannelPutData() .
MPK_CONFIG_FRAME_CACHE_SIZE	int	100	Specifies the cache size for the MPKConfig's frame data queue used for culling. This attribute affects the granularity and performance of the data processing for data passed using mpkConfigFrameData() .
MPK_DEFAULT_EYE_OFFSET	float	0.035	Specifies the default value of the eye offset used by the frustum computations for the channel. The function mpkInit() sets this value to 0.035.
MPK_DEFAULT_RUNON_POLICY	enum	auto	Specifies the default run-on policy for those window threads that are not explicitly bound to a particular processor. Setting the value to <code>auto</code> causes MPK to bind the first <i>n</i> window threads to the <i>n</i> processors on the node for the respective pipe. If the value is set to <code>free</code> , the operating system decides on what processor to execute the thread. The default is <code>free</code> .
MPK_PATTR_MONO_HEIGHT	int	492 is used for MPK_STEREO_REC, MPK_STEREO_BOT, and MPK_STEREO_TOP.	Specifies the height of the display to be used by the function mpkWindowUpdatePixelViewport() for mono mode instead of that returned by the X11 DisplayHeight() function.

Table 6-11 MPK Global Attributes (continued)

Variable	Data Type	Default Value	Description
MPK_PATTR_MONO_WIDTH	int		Specifies the width of the display to be used by the function mpkWindowUpdatePixelViewport() for mono mode instead of that returned by the X11 DisplayWidth() function.
MPK_PATTR_STEREO_HEIGHT	int	492 for full	Specifies the height of the display to be used by the function mpkWindowUpdatePixelViewport() for stereo mode instead of that returned by the X11 DisplayHeight() function.
MPK_PATTR_STEREO_OFFSET	int	532	Specifies the offset of the display to be used by the function mpkWindowUpdatePixelViewport() for rect and bottom stereo modes.
MPK_PATTR_STEREO_TYPE	enum	none	Specifies one of the following stereo types: none, user, quad, rect, top, or bottom.
MPK_PATTR_STEREO_WIDTH	int		Specifies the width of the display to be used by the function mpkWindowUpdatePixelViewport() for stereo mode instead of that returned by the X11 DisplayWidth() function.
MPK_WATTR_HINTS_CAVEAT	enum	MPK_UNDEFINED	Specifies the caveats associated with the window framebuffer configuration. Accepted values are MPK_GLX_SLOW , MPK_GLX_NOCAVEAT , and MPK_GLX_NON_CONFORMANT .
MPK_WATTR_HINTS_DECORATION	boolean	MPK_UNDEFINED	Specifies whether the window should have window manager decorations.
MPK_WATTR_HINTS_DIRECT	boolean	MPK_UNDEFINED	Specifies whether the window GLX context should be direct.

Table 6-11 MPK Global Attributes (**continued**)

Variable	Data Type	Default Value	Description
MPK_WATTR_HINTS_DOUBLEBUFFER	boolean	1	Specifies whether the window framebuffer configuration should be double-buffered. Note that setting this attribute on a window will affect the behavior of the function mpkWindowSwapBuffers() .
MPK_WATTR_HINTS_DRAWABLE	enum	MPK_UNDEFINED	Specifies the window drawable type. Accepted values are MPK_GLX_WINDOW, MPK_GLX_PBUFFER, MPK_GLX_PIXMAP, and MPK_GLX_NONE. For MPK_GLX_NONE, MPK executes no draw operation.
MPK_WATTR_HINTS_LARGEST	boolean	MPK_UNDEFINED	Specifies the MPKWindow pbuffer characteristics. This attribute will be ignored by windows for which the DRAWABLE hint is not set to MPK_GLX_PBUFFER.
MPK_WATTR_HINTS_PRESERVED	boolean	MPK_UNDEFINED	Specifies the MPKWindow pbuffer characteristics. This attribute will be ignored by windows for which the DRAWABLE hint is not set to MPK_GLX_PBUFFER.
MPK_WATTR_HINTS_RGBA	boolean	1	Specifies whether RGBA visuals are used. If the hint is not set, a color-index visual is used.
MPK_WATTR_HINTS_STEREO	boolean	MPK_UNDEFINED	Specifies whether the window framebuffer configuration should support quad-buffer stereo.
MPK_WATTR_HINTS_THREAD	boolean	MPK_UNDEFINED	Specifies whether the window should be made a separate thread from the application.

Table 6-11 MPK Global Attributes (**continued**)

Variable	Data Type	Default Value	Description
MPK_WATTR_HINTS_TRANSPARENT	boolean	MPK_UNDEFINED	Specifies whether the window framebuffer configuration should be transparent.
MPK_WATTR_HINTS_VISUAL	enum	MPK_UNDEFINED	Specifies the window visual type. Accepted values are MPK_GLX_TRUE_COLOR, MPK_GLX_PSEUDO_COLOR, MPK_GLX_DIRECT_COLOR, MPK_GLX_STATIC_COLOR, MPK_GLX_GRAYSCALE, and MPK_GLX_STATIC_GRAY.
MPK_WATTR_HINTS_X_RENDERABLE	boolean	MPK_UNDEFINED	Specifies whether only framebuffer configuration that have associated X visuals (and can be used to render to windows and/or GLX pixmaps) should be considered.
MPK_WATTR_HINTS_XINERAMA	boolean	Conditional. See the description.	Determines if a window should be created using Xinerama (if enabled). Setting it to 1 causes the window to be created using Xinerama and setting it to 0 causes a Xinerama-aware window to be created. The default value is 1 if the XINERAMA_AWARE environment variable is not set. If XINERAMA_AWARE is set, the default value is the opposite value of XINERAMA_AWARE.
MPK_WATTR_PLANES_ACCUM_ALPHA	int	MPK_UNDEFINED	Specifies the minimum number of accumulation alpha bitplanes. This attribute is ignored if the RGBA hint of the window is not set.
MPK_WATTR_PLANES_ACCUM_BLUE	int	MPK_UNDEFINED	Specifies the minimum number of accumulation blue bitplanes. This attribute is ignored if the RGBA hint of the window is not set.

Table 6-11 MPK Global Attributes (**continued**)

Variable	Data Type	Default Value	Description
MPK_WATTR_PLANES_ACCUM_GREEN	int	MPK_UNDEFINED	Specifies the minimum number of accumulation green bitplanes. This attribute is ignored if the RGBA hint of the window is not set.
MPK_WATTR_PLANES_ACCUM_RED	int	MPK_UNDEFINED	Specifies the minimum number of accumulation red bitplanes. This attribute is ignored if the RGBA hint of the window is not set.
MPK_WATTR_PLANES_ALPHA	int	0	Specifies the minimum number of alpha bitplanes. This attribute is ignored if the RGBA hint of the window is not set.
MPK_WATTR_PLANES_AUX	int	MPK_UNDEFINED	Specifies the number of auxiliary buffers.
MPK_WATTR_PLANES_BLUE	int	1	Specifies the minimum number of blue bitplanes. This attribute is ignored if the RGBA hint of the window is not set.
MPK_WATTR_PLANES_COLOR	int	MPK_UNDEFINED	Specifies the minimum color-index buffer size. This attribute is ignored if the RGBA hint of the window is set to 1.
MPK_WATTR_PLANES_DEPTH	int	1	Specifies the minimum size of the depth buffer.
MPK_WATTR_PLANES_GREEN	int	1	Specifies the minimum number of green bitplanes. This attribute is ignored if the RGBA hint of the window is not set.
MPK_WATTR_PLANES_LEVEL	int	0	Specifies the window buffer level.
MPK_WATTR_PLANES_RED	int	1	Specifies the minimum number of red bitplanes. This attribute is ignored if the RGBA hint of the window is not set.
MPK_WATTR_PLANES_SAMPLES	int	MPK_UNDEFINED	Specifies the minimum number of samples required in the multi-sample buffer.

Table 6-11 MPK Global Attributes (**continued**)

Variable	Data Type	Default Value	Description
MPK_WATTR_PLANES_STENCIL	int	MPK_UNDEFINED	Specifies the minimum size of the stencil buffer.
MPK_WATTR_TRANSPARENT_ALPHA	int	MPK_UNDEFINED	Specifies the alpha component of the window transparent color. This attribute is ignored if the RGBA hint of the window is not set or if the TRANSPARENT hint of the window is not set.
MPK_WATTR_TRANSPARENT_BLUE	int	MPK_UNDEFINED	Specifies the blue component of the window transparent color. This attribute is ignored if the RGBA hint of the window is not set or if the TRANSPARENT hint of the window is not set.
MPK_WATTR_TRANSPARENT_GREEN	int	MPK_UNDEFINED	Specifies the green component of the window transparent color. This attribute is ignored if the RGBA hint of the window is not set or if the TRANSPARENT hint of the window is not set.
MPK_WATTR_TRANSPARENT_INDEX	int	MPK_UNDEFINED	Specifies the window transparent index. This attribute is ignored if the RGBA hint of the window is set or if the TRANSPARENT hint of the window is not set.

Table 6-11 MPK Global Attributes (**continued**)

Variable	Data Type	Default Value	Description
MPK_WATTR_TRANSPARENT_RED	int	MPK_UNDEFINED	Specifies the red component of the window transparent color. This attribute is ignored if the RGBA hint of the window is not set or if the TRANSPARENT hint of the window is not set.
MPK_XINERAMA	boolean	1	Controls window-initialization performance. This variable can be set to 0 if all windows are created using Xinerama, which is the default behavior. Setting it to 0 improves window-initialization performance but causes problems when creating Xinerama-aware windows.

You can find more information about the window attributes specifications in the `glXChooseFBConfigSGIX(3G)` and `glXChooseVisual(3G)` man pages.

Index

Numbers

2D decomposition, 34
2D tiles, 61
3D decomposition, 43

A

accumulation techniques, 44
attributes data structure, 78

B

blending, 44

C

Cave facility, 1
channel attributes, 81
channel data structures
 configuration file format, 78
 functional view, 14
channels (See data structures.)
compositors (See Scalable Graphics Compositor.)
compound data structures
 configuration file format, 83
 functional view, 32

compounds (See decomposition and compound data structures.)
config data structures
 configuration file format, 69
 functional view, 12
configuration file
 channel data structure, 78
 comments (#), 65
 compound data structure, 83
 config data structure, 12, 69
 delimiters, 65
 field types, 67
 file format, 65
 global data structure, 87
 pipe data structure, 70
 sample, 6
 window data structure, 72
cull decomposition, 31, 47
cut-ins, 61

D

data streaming, 43
data structures
 attributes (channel), 78
 channel, 14, 78
 compound, 32, 83
 config, 12, 69
 functional view, 9
 global, 87
 hierarchy, 12

- pipe, 12, 70
- syntax, 66
- window, 13, 72

database decomposition, 36

DB decomposition, 36

decomposition

- building compounds, 32
- cull decomposition, 31, 47
- frame decomposition, 34
 - database, 36
 - eye, 38
 - head-mounted-device (HMD), 40
 - screen, 34
- guidelines for choosing mode, 57
- hardware decomposition, 61
- list of schemes, 33
- multilevel decomposition, 49
- overview, 4, 31
- pixel-based decomposition (FSAA), 44
- temporal decomposition, 40
 - data streaming, 43
 - frame multiplexing, 40

destination channels, 31

DisplayHeight() function, 13, 90, 91

DisplayWidth() function, 13, 91

DPLEX (See Video Digital Multiplexer.)

DPLEX decomposition, 40, 59

E

eye decomposition, 38

F

frame decomposition, 34

frame multiplexing, 40

framebuffer resources, 9

frusta

- immersive environments, 21
- orthographic, 18
- perspective, 18

FSAA (See full-scene antialiasing.)

full-scene antialiasing (FSAA), 45, 61

functions

- DisplayHeight(), 13, 90, 91
- DisplayWidth(), 13, 91
- glXChooseFBConfigSGIX(), 96
- glXChooseVisual(), 96
- mpkChannelPassData(), 89
- mpkChannelPutData(), 90
- mpkChannelSetNearFar(), 88
- mpkConfigFrameData(), 90
- mpkInit(), 90
- mpkSwapBuffers(), 92
- mpkWindowUpdatePixelViewport(), 90, 91

G

global attributes

- format, 87
- MPK_CATTR_READ_COLOR_FORMAT, 88
- MPK_CATTR_READ_COLOR_TYPE, 89
- MPK_CATTR_READ_DEPTH_FORMAT, 89
- MPK_CATTR_READ_DEPTH_TYPE, 89
- MPK_CATTR_READ_STENCIL_FORMAT, 89
- MPK_CATTR_READ_STENCIL_TYPE, 89
- MPK_CHANNEL_PASS_CACHE_SIZE, 89
- MPK_CHANNEL_PUT_CACHE_SIZE, 90
- MPK_CONFIG_FRAME_CACHE_SIZE, 90
- table of, 88

global data structures

- configuration file format, 87
- global attributes, 87

glXChooseFBConfigSGIX() function, 96

glXChooseVisual(3G) function, 96

H

hardware composition schemes, 61
 head-mounted-device (HMD) decomposition, 40
 HMD (See head-mounted-device (HMD)
 decomposition.)
 horizontal stripes, 61

I

immersive environments (See projection systems.)
 InfinitePerformance graphics systems, 60
 InfiniteReality graphics systems, 42

L

latency, 34
 load balancing
 auto load balancing, 33, 53, 84
 general, 33

M

mirrored projection systems, 14
 MPK_CATTR_FAR global attribute, 88
 MPK_CATTR_NEAR global attribute, 88
 MPK_CATTR_READ_COLOR_FORMAT global
 attribute, 88
 MPK_CATTR_READ_COLOR_TYPE global
 attribute, 89
 MPK_CATTR_READ_DEPTH_FORMAT global
 attribute, 89
 MPK_CATTR_READ_DEPTH_TYPE global
 attribute, 89
 MPK_CATTR_READ_STENCIL_FORMAT global
 attribute, 89

MPK_CATTR_READ_STENCIL_TYPE global
 attribute, 89
 MPK_CHANNEL_PASS_CACHE_SIZE global
 attribute, 89
 MPK_CHANNEL_PUT_CACHE_SIZE global
 attribute, 90
 MPK_CONFIG_FRAME_CACHE_SIZE global
 attribute, 90
 MPK_DEFAULT_EYE_OFFSET global attribute, 90
 MPK_DEFAULT_RUNON_POLICY global attribute,
 90
 MPK_PATTR_MONO_HEIGHT global attribute, 73,
 90
 MPK_PATTR_MONO_WIDTH global attribute, 73,
 91
 MPK_PATTR_STEREO_HEIGHT global attribute,
 73, 91
 MPK_PATTR_STEREO_OFFSET global attribute, 73,
 91
 MPK_PATTR_STEREO_TYPE global attribute, 73, 91
 MPK_PATTR_STEREO_WIDTH global attribute, 73,
 91
 MPK_WATTR_HINTS_CAVEAT global attribute, 74,
 91
 MPK_WATTR_HINTS_DECORATION global
 attribute, 75, 91
 MPK_WATTR_HINTS_DIRECT global attribute, 75,
 91
 MPK_WATTR_HINTS_DOUBLEBUFFER global
 attribute, 74, 92
 MPK_WATTR_HINTS_DRAWABLE global attribute,
 75, 92
 MPK_WATTR_HINTS_LARGEST global attribute,
 75, 92
 MPK_WATTR_HINTS_PRESERVED global attribute,
 75, 92
 MPK_WATTR_HINTS_RGBA global attribute, 74, 92
 MPK_WATTR_HINTS_STEREO global attribute, 75,

92

MPK_WATTR_HINTS_THREAD global attribute, 92
MPK_WATTR_HINTS_TRANSPARENT global attribute, 74, 93
MPK_WATTR_HINTS_VISUAL global attribute, 74, 93
MPK_WATTR_HINTS_X_RENDERABLE global attribute, 74, 93
MPK_WATTR_HINTS_XINERAMA global attribute, 75, 93
MPK_WATTR_PLANES_ACCUM_ALPHA global attribute, 77, 93
MPK_WATTR_PLANES_ACCUM_BLUE global attribute, 77, 93
MPK_WATTR_PLANES_ACCUM_GREEN global attribute, 77, 94
MPK_WATTR_PLANES_ACCUM_RED global attribute, 77, 94
MPK_WATTR_PLANES_ALPHA global attribute, 77, 94
MPK_WATTR_PLANES_AUX global attribute, 76, 94
MPK_WATTR_PLANES_BLUE global attribute, 77, 94
MPK_WATTR_PLANES_COLOR global attribute, 76, 94
MPK_WATTR_PLANES_DEPTH global attribute, 76, 94
MPK_WATTR_PLANES_GREEN global attribute, 77, 94
MPK_WATTR_PLANES_LEVEL global attribute, 76, 94
MPK_WATTR_PLANES_RED global attribute, 77, 94
MPK_WATTR_PLANES_SAMPLES global attribute, 76, 94
MPK_WATTR_PLANES_STENCIL global attribute, 76, 95

MPK_WATTR_TRANSPARENT_ALPHA global attribute, 77
MPK_WATTR_TRANSPARENT_BLUE global attribute, 77, 95
MPK_WATTR_TRANSPARENT_GREEN global attribute, 77, 95
MPK_WATTR_TRANSPARENT_INDEX global attribute, 77
MPK_WATTR_TRANSPARENT_RED global attribute, 77, 96
MPK_XINERAMA global attribute, 75, 96
mpkChannelPassData() function, 89
mpkChannelPutData() function, 90
mpkChannelSetNearFar() function, 88
mpkConfigFrameData() function, 90
mpkInit() function, 90
mpkWindowSwapBuffers() function, 92
mpkWindowUpdatePixelViewport() function, 90, 91
multilevel decomposition, 49
multipass rendering, 45

O

orthographic frusta, 18

P

parallel processing, 31
perspective frusta, 18
pipe data structures
 configuration file format, 70
 functional view, 12
pipes (See data structures.)
pixel-based decomposition (FSAA), 44
processor assignment, 70, 73, 90
product components, 5

projection model coordinates, 24

projection systems

 Cave facility, 1

 frusta, 21

 modeling methods, 22

 RESPONSIVE WORKBENCH facility, 24, 30

 SGI Reality Center facility, 1, 24, 28

 TAN HOLOBENCH facility, 1, 23, 27

 TANORAMA POWERWALL facility, 1, 23, 26

 V-Dome facility, 24, 29

R

Reality Center facility, 1, 24, 28

RESPONSIVE WORKBENCH facility, 24, 30

run-on policy, 70, 73, 90

run-time configurability, 3

S

scalability, 4

 definition, 34

 full-scalability feature, 42

 general support, 4

 hardware solution, 59

 MPK implementation, 31

Scalable Graphics Compositor, 4, 44, 45, 59, 60

screen decomposition, 34

SGI Reality Center facility, 1, 24, 28

source channels, 31

split-axis method for tiling, 55

stereo

 conditional use of, 52

 general support, 4

 specifying the mode, 15

 switching on and off, 15

T

TAN HOLOBENCH facility, 1, 23, 27

TANORAMA POWERWALL facility, 1, 23, 26

temporal decomposition, 40

V

V-Dome facility, 24, 29

vertical stripes, 61

Video Digital Multiplexer (DPLEX), 4, 41, 59, 84

visualization facilities (See projection systems.)

volview application, 6

W

wall model coordinates, 23

window attributes, 74, 76, 96

window data structures

 configuration file format, 72

 functional view, 13

windows (See data structures.)

workload balance (See load balancing.)

X

Xinerama, 63, 75, 93, 96

