

# SGI® Altix® XE310 System User's Guide

007-4960-004

---

## CONTRIBUTORS

Written by Jim Ostrom

Revised by Ken Jones

Engineering contributions by James Zenner, Steve Bowen, Dick Brownell, Darrin Goss, Daniel Gragert, Matt Marchese, Jim Rada, Bob Sanders, Mark Schwenden, Ted Wood, Chris Wengelski.

---

## COPYRIGHT

© 2007 SGI. All rights reserved; provided portions may be copyright in third parties, as indicated elsewhere herein. No permission is granted to copy, distribute, or create derivative works from the contents of this electronic documentation in any manner, in whole or in part, without the prior written permission of SGI.

---

## LIMITED RIGHTS LEGEND

The software described in this document is “commercial computer software” provided with restricted rights (except as to included open/free source) as specified in the FAR 52.227-19 and/or the DFAR 227.7202, or successive sections. Use beyond license provisions is a violation of worldwide intellectual property laws, treaties and conventions. This document is provided with limited rights as defined in 52.227-14.

The electronic (software) version of this document was developed at private expense; if acquired under an agreement with the USA government or any contractor thereto, it is acquired as “commercial computer software” subject to the provisions of its applicable license agreement, as specified in (a) 48 CFR 12.212 of the FAR; or, if acquired for Department of Defense units, (b) 48 CFR 227-7202 of the DoD FAR Supplement; or sections succeeding thereto. Contractor/manufacturer is SGI, 1140 E. Arques Avenue, Sunnyvale, CA 94085.

---

## TRADEMARKS AND ATTRIBUTIONS

Altix, SGI, and the SGI logo are registered trademarks and SGI ProPack is a trademark of SGI in the United States and/or other countries worldwide.

InfiniBand is a registered trademark of the InfiniBand Trade Association. Intel, Itanium, and Xeon are trademarks or registered trademarks of Intel Corporation or its subsidiaries in the United States and other countries. Internet Explorer is a registered trademark of Microsoft Corporation. Java and Java Virtual Machine are trademarks or registered trademarks of Sun Microsystems, Inc. Linux is a registered trademark of Linus Torvalds, used with permission by SGI. LSI Logic is a registered trademark of LSI Logic Corporation. Novell and Novell Netware are registered trademarks of Novell Inc. Phoenix and PhoenixBIOS are registered trademarks of Phoenix Technologies Ltd. Red Hat and all Red Hat-based trademarks are trademarks or registered trademarks of Red Hat, Inc. in the United States and other countries. SUSE LINUX and the SUSE logo are registered trademarks of Novell, Inc. UNIX is a registered trademark in the United States and other countries, licensed exclusively through X/Open Company, Ltd.

All other trademarks mentioned herein are the property of their respective owners.

---

## Record of Revision

<b>Version</b>	<b>Description</b>
001	March 9, 2007 Original printing.
002	March 28, 2007 Added BMC interface descriptions to Appendix B. Added VCCI (Japan only) and Canada regulatory notices. Added information to the rack installation procedures.
003	October 2007 Added/Revised replacement procedures for heatsinks, thermal interface material, and processors. Added configuration rules for DIMMs. Added appendix for upgrading BIOS. Added appendix for SAS/RAID support.
004	November 2007 Corrected illustrations showing the rack rail extension hardware on the server chassis.



# Contents

	<b>About This Guide . . . . .</b>	<b>xxiii</b>
	Audience . . . . .	xxiii
	Important Information . . . . .	xxiii
	Chapter Descriptions . . . . .	xxiv
	Related Publications . . . . .	.xxv
	Conventions . . . . .	xxvi
	Product Support . . . . .	xxvi
	Reader Comments . . . . .	xxvii
<b>1</b>	<b>Introduction . . . . .</b>	<b>1</b>
	Node Board Features . . . . .	4
	Processors . . . . .	4
	Memory . . . . .	4
	Serial ATA (SATA) . . . . .	4
	Serial Attached SCSI (SAS) and RAID Support . . . . .	6
	PCIe Expansion Slots . . . . .	6
	Ethernet Ports . . . . .	6
	Onboard Controllers/Ports . . . . .	6
	ATI Graphics Controller . . . . .	6
	Other Features . . . . .	6
	Server Chassis Features . . . . .	7
	System Power . . . . .	7
	SATA/SAS Backplane/Drives . . . . .	7
	System Security and Pre-Installed Linux Operating Systems . . . . .	7

<b>2</b>	<b>Server Installation</b>	<b>9</b>
	Unpack the System	9
	Prepare for Setup	9
	Choose a Setup Location	9
	Warnings and Precautions	10
	Rack Precautions	10
	Server Precautions	11
	Rack Mounting Considerations	11
	Ambient Operating Temperature	11
	Reduced Airflow	11
	Mechanical Loading	11
	Circuit Overloading	12
	Reliable Ground	12
	Install the System into a Rack	12
	Identify the Sections of the Rack Rails	12
	Install the Rails	13
	Locking Tabs	16
	Install the Server in a Rack	17
	Install the Server in a Third-party Rack	19
	Check the Node Board Setup	22
	Access the Inside of the Chassis	22
	Check the CPUs (processors)	23
	Check the System Memory	23
	Install Expansion PCIe Cards	24
	Check all Cable Connections and Airflow	24
	Check the Drive Bay Setup	24
	Check the SATA/SAS Drives	24
	Check the Airflow	24
	Supply Power to the System	24

<b>3</b>	<b>Controls and Indicators</b>	<b>25</b>
	Controls	25
	Indicators	26
	SATA Drive Carrier Indicators	27
<b>4</b>	<b>Advanced Node Board Setup</b>	<b>29</b>
	Handling the Node Board	29
	ESD Precautions	30
	Unpacking	30
	Node Board Installation	31
	Connect the Power Cables	32
	Connecting the Control Panel	34
	I/O Ports	35
	Processor and Heatsink Installation and Removal	35
	Install a Processor	36
	Install a Heatsink	40
	Remove the Heatsink	41
	Replace the Thermal Interface Material	42
	Removing TIM from a Processor	42
	Removing TIM from a Heatsink	46
	Remove the Processor	48
	Install Memory	50
	Memory Layout	50
	Constraints for DIMM Pairs	51
	Performance Optimization	52
	Memory Sparing Mode	53
	Memory Mirroring Mode	53
	Mirroring Mode Upgrade	54
	Install DIMMs	54
	Install or Remove the Air Shroud	57
	Node Board Component Locations	58
	Add PCIe Expansion Cards	59
	Install a PCIe Expansion Card	59
	Node Board Jumpers and Connectors	61

Node Board Connector Pin Definitions . . . . .	. 63
ATX Power Connector Pin Definitions . . . . .	. 64
Auxiliary Power Connector Pin Definitions (JP10). . . . .	. 64
PW_ON Switch Pin Definitions (JF1) . . . . .	. 65
Reset Switch Pin Definitions (JF1) . . . . .	. 65
Overheat/Fan Pin Definitions (JF1) . . . . .	. 65
NIC2 LED Pin Definitions (JF1) . . . . .	. 66
NIC1 LED Pin Definitions (JF1) . . . . .	. 66
HDD LED Pin Definitions (JF1) . . . . .	. 66
Power On LED Pin Definitions (JF1) . . . . .	. 67
NMI Switch Pin Definitions (JF1) . . . . .	. 67
Fan Connector Pin Definitions (Fan1/2 - Fan7/8) . . . . .	. 68
Chassis Intrusion Connector Pin Definitions (JL1) . . . . .	. 68
USB Connector Pin Definitions (USB0/USB1). . . . .	. 69
Ethernet Port (LAN1/LAN2) . . . . .	. 70
Wake on LAN Connector Pin Definitions (JWOL). . . . .	. 70
Wake on Ring Connector Pin Definitions (JWOR). . . . .	. 70
Serial Port Pin Definitions (COM2). . . . .	. 71
Serial General Purpose I/O Connector Pin Definitions (SGPIO) . . . . .	. 71
System Management Bus Power Connector Pin Definitions (J17) . . . . .	. 72
System Management Bus Connector Pin Definitions (J18). . . . .	. 72
Node Board Jumper Settings . . . . .	. 73
Explanation of Jumper Settings . . . . .	. 74
CMOS Memory Clear (JBT1) . . . . .	. 75
VGA Jumper Settings (JPG1) . . . . .	. 76
I2C to PCIe Slot Jumper Settings (JPI2C1/JPI2C2). . . . .	. 76
LAN1/LAN2 Jumper Settings (JPL1/JPL2). . . . .	. 77
Watch Dog Timer Jumper Settings (JWD) . . . . .	. 78
Node Board LED Descriptions . . . . .	. 79
LAN1 and LAN2 (Ethernet Ports) . . . . .	. 79
Power LED (LE1) . . . . .	. 79
InfiniBand Link/Activity LEDs (LE2/LE3). . . . .	. 81



<b>5</b>	<b>Advanced Chassis Setup</b>	<b>83</b>
	ESD Precautions	83
	Chassis Components	84
	Control Panel	85
	Part Numbers and Marketing Codes	86
	System Fans	87
	System Fan Failure	87
	Disk Drive Replacement	87
	Disk Drive Installation	88
	Mounting a Drive in a Drive Carrier	88
	Drive Replacement	89
	Power Supply	90
	Power Supply Failure	90
	Power Supply Replacement	90
<b>6</b>	<b>BIOS Settings</b>	<b>93</b>
	Default Settings	93
	System BIOS	101
	How To Change the Configuration Data	101
	Starting the Setup Utility	101
	Running Setup	102
	Main BIOS Setup	103
	Main Setup Features	104
	System Time	104
	System Date	104
	BIOS Date	104
	Serial ATA Ports	105
	Type	105
	Multi-Sector Transfers	106
	LBA Mode Control	106
	32 Bit I/O	106
	Transfer Mode	106
	Ultra DMA Mode	106
	Native Mode Operation	106

SATA Controller Mode . . . . .	106
Serial ATA (SATA) RAID Enable . . . . .	107
ICH RAID Code Base (Available when SATA RAID is Enabled) . . . . .	107
SATA AHCI (Available when SATA RAID is Disabled) . . . . .	107
System Memory . . . . .	107
Extended Memory . . . . .	107
Advanced Setup . . . . .	108
Boot Features . . . . .	108
QuickBoot Mode . . . . .	108
QuietBoot Mode . . . . .	108
POST Errors . . . . .	109
ACPI Mode . . . . .	109
Power Button Behavior . . . . .	109
Resume On Modem Ring . . . . .	109
Power Loss Control . . . . .	109
Watch Dog . . . . .	109
Summary Screen . . . . .	109
Memory Cache . . . . .	110
Cache System BIOS Area . . . . .	110
Cache Base 0-512K . . . . .	110
Cache Base 512K-640K . . . . .	110
Cache Extended Memory . . . . .	110
PCIe Configuration . . . . .	111
Onboard GLAN1/Onboard GLAN2 (Gigabit- LAN) OPRM Configure . . . . .	111
Default Primary Video Adapter . . . . .	111
Emulated IRQ Solutions . . . . .	111
PCIe I/O Performance . . . . .	111
PCIe Parity Error Forwarding . . . . .	111
ROM Scan Ordering . . . . .	111
Reset Configuration Data . . . . .	112
Slot1 PCIe x8 . . . . .	112
Option ROM Scan . . . . .	112
Enable Master . . . . .	112

Latency Timer . . . . .	.112
Large Disk Access Mode . . . . .	.112
Advanced Chipset Control . . . . .	.112
SERR Signal Condition . . . . .	.113
4GB PCIe Hole Granularity . . . . .	.113
Memory Branch Mode . . . . .	.113
Branch 0/1 Rank Interleaving . . . . .	.113
Branch 0/1 Rank Sparing . . . . .	.113
Enhanced x8 Detection . . . . .	.113
High Bandwidth FSB . . . . .	.114
High Temperature DRAM Operation . . . . .	.114
AMB Thermal Sensor . . . . .	.114
Thermal Throttle . . . . .	.114
Global Activation Throttle . . . . .	.114
Snoop Filter . . . . .	.114
Crystal Beach Features . . . . .	.115
Route Port 80h Cycles to . . . . .	.115
Clock Spectrum Feature . . . . .	.115
High Precision Event Timer . . . . .	.115
USB Function . . . . .	.115
Legacy USB Support . . . . .	.115
Advanced Processor Options . . . . .	.116
CPU Speed . . . . .	.116
Frequency Ratio . . . . .	.116
Core-Multi-Processing . . . . .	.116
Machine Checking . . . . .	.116
Thermal Management 2 . . . . .	.116
C1 Enhanced Mode . . . . .	.116
Execute Disable Bit . . . . .	.117
Adjacent Cache Line Prefetch . . . . .	.117
Hardware Prefetch . . . . .	.117
Direct Cache Access . . . . .	.117
DCA Delay Clocks . . . . .	.117

Intel Virtualization Technology . . . . .	117
Intel EIST Support . . . . .	118
I/O Device Configuration . . . . .	118
Serial Port A . . . . .	118
Serial Port B . . . . .	118
DMI Event Logging . . . . .	119
Event Log Validity . . . . .	119
Event Log Capacity . . . . .	119
View DMI Event Log . . . . .	119
Event Logging . . . . .	119
ECC Event Logging . . . . .	119
Mark DMI Events as Read . . . . .	119
Clear All DMI Event Logs . . . . .	119
Console Redirection . . . . .	119
COM Port Address . . . . .	120
BAUD Rate . . . . .	120
Console Type . . . . .	120
Flow Control . . . . .	120
Console Connection . . . . .	120
Continue CR after POST . . . . .	120
Hardware Monitor . . . . .	120
CPU Temperature Threshold . . . . .	121
Fan Speed Control Modes . . . . .	121
Voltage Monitoring . . . . .	121
IPMI . . . . .	122
IPMI Specification Version . . . . .	122
Firmware Version . . . . .	122
System Event Logging . . . . .	122
Clear System Event Logging . . . . .	123
Existing Event Log Number . . . . .	123
Event Log Control . . . . .	123
System Event Log/System Event Log (List Mode) . . . . .	124
Realtime Sensor Data . . . . .	125

Security . . . . .	.126
Supervisor Password Is . . . . .	.126
User Password Is . . . . .	.126
Set Supervisor Password . . . . .	.127
Set User Password . . . . .	.127
Password on Boot . . . . .	.127
Boot . . . . .	.128
Boot Priority Order/Excluded from Boot Orders . . . . .	.128
Exit . . . . .	.129
Exit Saving Changes . . . . .	.130
Exit Discarding Changes . . . . .	.130
Load Setup Defaults . . . . .	.130
Discard Changes . . . . .	.130
Save Changes . . . . .	.130
<b>A BIOS Power-on Self Test . . . . .</b>	<b>.131</b>
BIOS POST Messages . . . . .	.131
BIOS POST Codes . . . . .	.137
Recoverable POST Errors . . . . .	.137
Terminal POST Errors . . . . .	.137
<b>B IPMI 2.0 Management Utility . . . . .</b>	<b>.145</b>
Network Connection. . . . .	.147
Functions Listed on the Home Page. . . . .	.148
Remote Control . . . . .	.150
KVM Console . . . . .	.150
Remote Power . . . . .	.151
Virtual Media . . . . .	.151
CD-ROM Image . . . . .	.152
Drive Redirection . . . . .	.154
Virtual Media Options . . . . .	.156
System Health . . . . .	.158
Chassis Control . . . . .	.158
Monitor Sensors . . . . .	.160

System Event Log . . . . .	162
Alert Settings . . . . .	163
User Management . . . . .	164
Change Password . . . . .	164
Users and Groups . . . . .	165
Permissions . . . . .	166
KVM Settings . . . . .	167
User Console . . . . .	167
Keyboard/Mouse . . . . .	170
Device Settings . . . . .	172
Network . . . . .	172
Dynamic DNS . . . . .	174
Security . . . . .	175
Certificate . . . . .	178
Date and Time . . . . .	180
Event Log . . . . .	182
SNMP Settings . . . . .	184
Maintenance . . . . .	185
Device Information . . . . .	185
Event Log . . . . .	187
Update Firmware . . . . .	188
Unit Reset . . . . .	188
Remote Console Main Page . . . . .	190
Remote Console Options . . . . .	191
Log Out . . . . .	192
<b>C Regulatory Specifications and Safety Information . . . . .</b>	<b>193</b>
Manufacturer's Regulatory Declarations. . . . .	193
Server Model Number . . . . .	193
CE Notice and Manufacturer's Declaration of Conformity . . . . .	193
Electromagnetic Emissions . . . . .	194
FCC Notice (USA Only) . . . . .	194
Industry Canada Notice (Canada Only) . . . . .	195
VCCI Class A Notice (Japan Only) . . . . .	195

	Shielded Cables . . . . .	.195
	Electrostatic Discharge . . . . .	.195
<b>D</b>	<b>System Specifications . . . . .</b>	<b>.197</b>
<b>E</b>	<b>System Safety . . . . .</b>	<b>.201</b>
	Electrical Safety Precautions . . . . .	.201
	Node Board Battery . . . . .	.202
	General Safety Precautions . . . . .	.203
	ESD Safety Precautions . . . . .	.204
	Operating Precautions . . . . .	.204
<b>F</b>	<b>Upgrading Your Server for SAS/RAID Support. . . . .</b>	<b>.205</b>
	Installing the HBAs . . . . .	.205
	Creating RAID Volumes . . . . .	.207
<b>G</b>	<b>Upgrading BIOS . . . . .</b>	<b>.209</b>
	Requirements . . . . .	.209
	Setting up the Virtual Media Boot Feature . . . . .	.210
	Booting the Virtual Media DOS Image . . . . .	.211
<b>I</b>	<b>Index . . . . .</b>	<b>.213</b>





# Figures

Figure 1-1	SGI Altix XE310 Server . . . . .	1
Figure 1-2	Chassis Components . . . . .	3
Figure 1-3	Node Board Block Diagram . . . . .	5
Figure 2-1	Identify Sections of the Rack Rails (right side rail shown) . . . . .	13
Figure 2-2	Rail Assembly . . . . .	13
Figure 2-3	Attaching the Inner Bracket . . . . .	14
Figure 2-4	Attaching the Rail to the Front of the Rack (View from Front of Rack) . . . . .	15
Figure 2-5	Attaching the Rail to the Rear of the Rack (View from Rear of Rack) . . . . .	15
Figure 2-6	Install the Rack Rails. . . . .	16
Figure 2-7	Install the Server in a Rack . . . . .	18
Figure 2-8	Install the Server in a Third-party Rack (1) . . . . .	19
Figure 2-11	Remove the Top Cover . . . . .	23
Figure 3-1	Front Panel Controls and Indicators . . . . .	26
Figure 4-1	Remove the Top Cover . . . . .	31
Figure 4-2	Node Board Installation . . . . .	33
Figure 4-3	Control Panel Connector (JF1) Pin Definitions . . . . .	34
Figure 4-4	I/O Port Locations . . . . .	35
Figure 4-5	Install a CPU Heatsink . . . . .	41
Figure 4-6	Minimum Population for Dual-Channel Mode with Identical FBDIMMs . . . . .	51
Figure 4-7	Standard DIMM Population for Sparing or Mirroring . . . . .	53
Figure 4-8	Install DIMMs . . . . .	55
Figure 4-9	Replace DIMMs . . . . .	56
Figure 4-10	Install Air Shrouds . . . . .	57
Figure 4-11	Node Board Component Locations . . . . .	58
Figure 4-12	Install a PCI Card . . . . .	60
Figure 4-13	Explanation of Jumper Pins . . . . .	74

Figure 4-14	CMOS Memory Jumper Location (JBT1)	. 75
Figure 4-15	LAN 1 and LAN 2 Jumper Locations (JPL1/JPL2)	. 77
Figure 4-16	Watch Dog Timer Jumper Location (JWD)	. 78
Figure 4-17	InfiniBand Link LED Location (LE1)	. 80
Figure 4-18	InfiniBand Link LED Location (LE2)	. 81
Figure 5-1	Chassis Front View	. 84
Figure 5-2	Chassis Rear View	. 84
Figure 5-3	JF1 Connector Location	. 85
Figure 5-4	Disk Drive Carrier	. 88
Figure 5-5	Drive Removal	. 89
Figure 5-6	Power Supply Replacement	. 91
Figure 6-1	Main BIOS Setup Menu	. 103
Figure B-1	BMC Remote Console	. 148
Figure B-2	Remote Console Screen	. 150
Figure B-3	CD-ROM Image	. 152
Figure B-4	Drive Redirection	. 154
Figure B-5	Virtual Media Options	. 156
Figure B-6	Chassis Control	. 158
Figure B-7	Monitor Sensors	. 160
Figure B-8	System Event Log	. 162
Figure B-9	Alert Settings	. 163
Figure B-10	User Console Settings	. 168
Figure B-11	Keyboard/Mouse Settings	. 170
Figure B-12	Network Settings	. 172
Figure B-13	Dynamic DNS Settings	. 174
Figure B-14	Security Settings	. 176
Figure B-15	Certificate Settings	. 178
Figure B-16	Date and Time Settings	. 180
Figure B-17	Event Log	. 182
Figure B-18	SNMP Settings	. 184
Figure B-19	Device Information	. 186
Figure B-20	Event Log	. 187
Figure B-21	Update Firmware	. 188

Figure B-22	Unit Reset . . . . .	.189
Figure B-23	Remove Console Screen . . . . .	.190
Figure B-24	Remote Console Options. . . . .	.191
Figure E-1	Install the Battery. . . . .	.202



## Tables

Table 4-1	Recommended DIMM Configurations . . . . .	52
Table 4-2	DIMM Configurations . . . . .	55
Table 4-3	Node Board Default Jumper Settings . . . . .	61
Table 4-4	Node Board Connector Descriptions . . . . .	61
Table 4-5	Node Board LED Descriptions . . . . .	62
Table 4-6	Node Board Connector Pin Definitions . . . . .	63
Table 4-7	ATX Power Connector Pin Definitions . . . . .	64
Table 4-8	Auxiliary Power Connector Pin Definitions (JP10) . . . . .	64
Table 4-9	PW_ON Switch Pin Definitions (JF1) . . . . .	65
Table 4-10	Reset Switch Pin Definitions (JF1) . . . . .	65
Table 4-11	Overheat/Fan Fail LED Pin Definitions (JF1) . . . . .	65
Table 4-12	NIC2 LED Pin Definitions (JF1). . . . .	66
Table 4-13	NIC1 LED Pin Definitions . . . . .	66
Table 4-14	HDD LED Pin Definitions (JF1). . . . .	66
Table 4-15	Power On LED Pin Definitions (JF1) . . . . .	67
Table 4-16	NMI Button Pin Definitions (JF1) . . . . .	67
Table 4-17	Fan Header Pin Definitions (Fan1/2 - Fan7/8) . . . . .	68
Table 4-18	Chassis Intrusion Pin Definitions (JL1) . . . . .	68
Table 4-19	Universal Serial Bus (USB) Pin Definitions . . . . .	69
Table 4-20	Ethernet Ports (LAN1/LAN2) . . . . .	70
Table 4-21	Wake on LAN Connector Pin Definitions (JWOL) . . . . .	70
Table 4-22	Wake on Ring Connector Pin Definitions . . . . .	70
Table 4-23	Serial Port Pin Definitions (COM2) . . . . .	71
Table 4-24	Serial General Purpose I/O Connector Pin Definitions (SGPIO) . . . . .	71
Table 4-25	SMB Power Connector Pin Definitions (J17) . . . . .	72

Table 4-26	SMB Header Pin Definitions (J18)	. . . . .	.72
Table 4-27	Node Board Jumper Descriptions	. . . . .	.73
Table 4-28	VGA Jumper Settings (JPG1)	. . . . .	.76
Table 4-29	I2C to PCIe Slot Jumper Settings	. . . . .	.76
Table 4-30	LAN1/LAN2 Jumper Settings (JPL1/JPL2)	. . . . .	.77
Table 4-31	Watch Dog Timer Jumper Settings (JWD)	. . . . .	.78
Table 4-32	LAN1 and LAN 2 LED Descriptions	. . . . .	.79
Table 4-33	Power LED Description (LE1)	. . . . .	.79
Table 4-34	InfiniBand Link/Activity LED Descriptions (LE2/LE3)	. . . . .	.81
Table 5-1	Part Numbers and Marketing Codes	. . . . .	.86
Table 6-1	BIOS Default Settings	. . . . .	.93
Table A-1	BIOS Post Codes	. . . . .	137
Table B-1	Health Monitoring Sensors	. . . . .	161
Table D-1	SGI Altix XE310 System Specifications	. . . . .	197

---

## About This Guide

This guide provides an overview of the installation, architecture, general operation, and descriptions of the major components in the SGI® Altix® XE310 server. It also provides basic troubleshooting and maintenance information, BIOS information, and important safety and regulatory specifications.

### Audience

This guide is written for owners, installers, system administrators, and users of SGI Altix XE310 computer systems. It is written with the assumption that the reader has a good working knowledge of computers and computer systems.

### Important Information



---

**Warning:** To avoid problems that could void your warranty, your SGI or other approved system support engineer (SSE) should perform any replacement of parts or service of your SGI Altix XE310 system not covered in the following list of items that you can perform yourself:

---

- Install the server into system rack(s).
- Replace the power supply, power distribution board, or fans in the server chassis.
- Replace disk drives or SATA backplane in the server chassis.
- Replace processors, memory, or processor heatsinks on the node board.
- Add or replace PCIe cards or the baseboard management controller (BMC)
- Replace cables

---

## Chapter Descriptions

The following topics are covered in this guide:

- Chapter 1, “Introduction,” provides a checklist of the main components included with the system and describes the main features of the SGI Altix XE310 and its node boards.
- Chapter 2, “Server Installation,” describes the steps necessary to install the system into a rack and check out the server configuration prior to powering up the system. If your server was ordered without the processor and memory components, this chapter will refer you to the appropriate sections of the manual for their installation.
- Chapter 3, “Controls and Indicators,” provides details on the system interface, which includes the functions and information provided by the control panel on the chassis, as well as other LEDs located throughout the system.
- Chapter 4, “Advanced Node Board Setup,” provides detailed information on the 1U rackmount server chassis. Follow the procedures in this chapter when you install, remove, or reconfigure SAS/SATA or peripheral drives and when you replace system power supply units and cooling fans.
- Chapter 5, “Advanced Chassis Setup,” provides detailed information about the components inside the server chassis, such as the node board connectors and jumper settings, disk drive information, and power supply replacement.
- Chapter 6, “BIOS Settings,” includes an introduction to BIOS and provides detailed information on running the CMOS Setup Utility.
- Appendix A, “BIOS Power-on Self Test,” provides information about BIOS POST self-test messages and codes.
- Appendix B, “IPMI 2.0 Management Utility,” provides information about how to start the baseboard management controller (BMC) intelligent platform management interface (IPMI 2.0 management utility).
- Appendix C, “Regulatory Specifications and Safety Information,” lists regulatory information that may be important to the operation of your system.
- Appendix D, “System Specifications,” provides physical, environmental, and power specifications for your system.
- Appendix E, “System Safety,” provides a general overview of safety precautions that should be followed when installing and servicing the SGI Altix XE310.
- Appendix F, “Upgrading Your Server for SAS/RAID Support,” describes how to upgrade your server to use SAS hard drives as well as SATA hard drives by using model LSISAS3041E HBAs. This HBA option also can provide support for RAID 0, RAID 1, or JBOD.



- Appendix G, “Upgrading BIOS,” gives an overview of the various methods for upgrading BIOS and the details for upgrading clusters via the BMC web interface.

## Related Publications

The following SGI and LSI documents are relevant to the SGI Altix XE310 server:

- *SGI Altix XE1300 Cluster Quick Reference Guide*, publication number 007-4979-00x
- *SGI ProPack 5 for Linux Start Here*, publication number 007-4837-00x
- *SGI InfiniteStorage* series documentation
- *PCI Express to 3.0 Gbit/s Serial Attached SCSI (SAS) Host Bus Adapters User’s Guide*, publication number 860-0477-001
- *Integrated RAID for SAS User’s Guide*, publication number 860-0477-001
- Man pages (online)

You can obtain SGI documentation (as well as the pertinent LSI books), release notes, or man pages in the following ways:

- Refer to the SGI Technical Publications Library at <http://docs.sgi.com>. Various formats are available. This library contains the most recent and most comprehensive set of online books, release notes, man pages, and other information.
- You can also view man pages by typing `man <title>` on a command line.

SGI systems include a set of Linux® man pages, formatted in the standard UNIX® “man page” style. Important system configuration files and commands are documented on man pages. These are found online on the internal system disk (or DVD-ROM) and are displayed using the `man` command. For example, to display the man page for the `xscsidisktest` command, type the following on a command line:

```
man xscsidisktest
```

For additional information about displaying man pages using the `man` command, see `man (1)`.

In addition, the `apropos` command locates man pages based on keywords. For example, to display a list of man pages that describe disks, type the following on a command line:

```
apropos disk
```

For information about setting up and using `apropos`, see `apropos (1)`.

---

## Conventions

The following conventions are used throughout this document:

<b>Convention</b>	<b>Meaning</b>
Command	This fixed-space font denotes literal items such as commands, files, routines, path names, signals, messages, and programming language structures.
<i>variable</i>	The italic typeface denotes variable entries and words or concepts being defined. Italic typeface is also used for book titles.
<b>user input</b>	This bold fixed-space font denotes literal items that the user enters in interactive sessions. Output is shown in nonbold, fixed-space font.
[ ]	Brackets enclose optional portions of a command or directive line.
...	Ellipses indicate that a preceding element can be repeated.
man page(x)	Man page section identifiers appear in parentheses after man page names.
<b>GUI element</b>	This font denotes the names of graphical user interface (GUI) elements such as windows, screens, dialog boxes, menus, toolbars, icons, buttons, boxes, fields, and lists.

## Product Support

SGI provides a comprehensive product support and maintenance program for its products. SGI also offers services to implement and integrate Linux applications in your environment.

- Refer to <http://www.sgi.com/support/>
- If you are in North America, contact the Technical Assistance Center at +1 800 800 4SGI or contact your authorized service provider.
- If you are outside North America, contact the SGI subsidiary or authorized distributor in your country.

---

## Reader Comments

If you have comments about the technical accuracy, content, or organization of this document, contact SGI. Be sure to include the title and document number of the manual with your comments. (Online, the document number is located in the front matter of the manual. In printed manuals, the document number is located at the bottom of each page.)

You can contact SGI in any of the following ways:

- Send e-mail to the following address: [techpubs@sgi.com](mailto:techpubs@sgi.com)
- Contact your customer service representative and ask that an incident be filed in the SGI incident tracking system.
- Send mail to the following address:

SGI  
Technical Publications  
1140 East Arques Avenue  
Sunnyvale, CA 94085-4602

SGI values your comments and will respond to them promptly.



## Introduction

The SGI Altix XE310 server is a 1U rackmount server (refer to Figure 1-1) that contains two node boards in a single chassis. Each node supports two Intel® Xeon® quad-core processors.

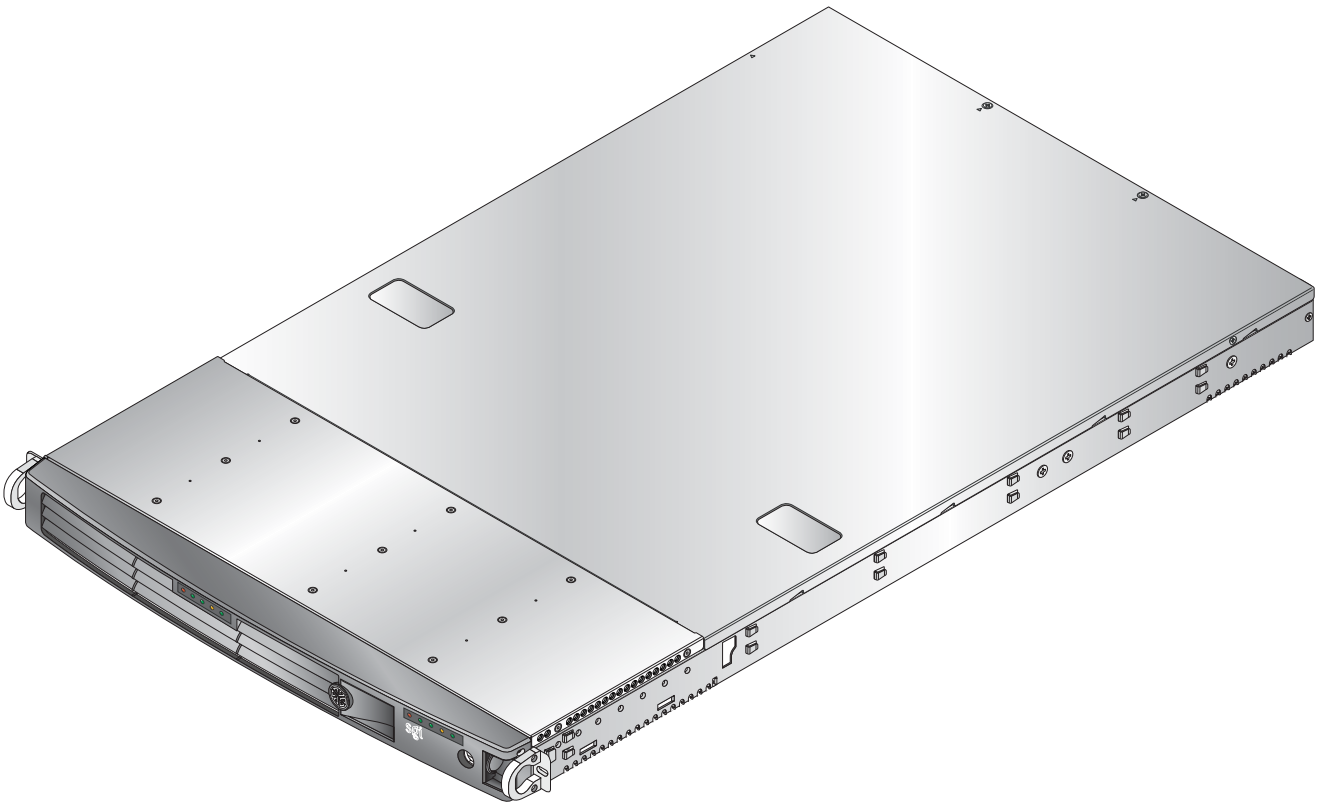

**Figure 1-1** SGI Altix XE310 Server

In addition to the node and chassis, the following hardware components are included (refer to Figure 1-2):

- Two dual-core or quad-core processors per node board
- Two processor heatsinks per node board
- Four hard drive carriers
- One internal SATA backplane
- One SATA cable set
- Two PCIe x8 riser cards
- Two IPMI 2.0 baseboard management cards (BMCs)
- Six 4-cm high-performance fans
- One air shroud for 1U chassis
- Rackmount hardware with screws
  - Two rack rail assemblies
  - Six brackets for mounting the rack rails in a rack/telco rack

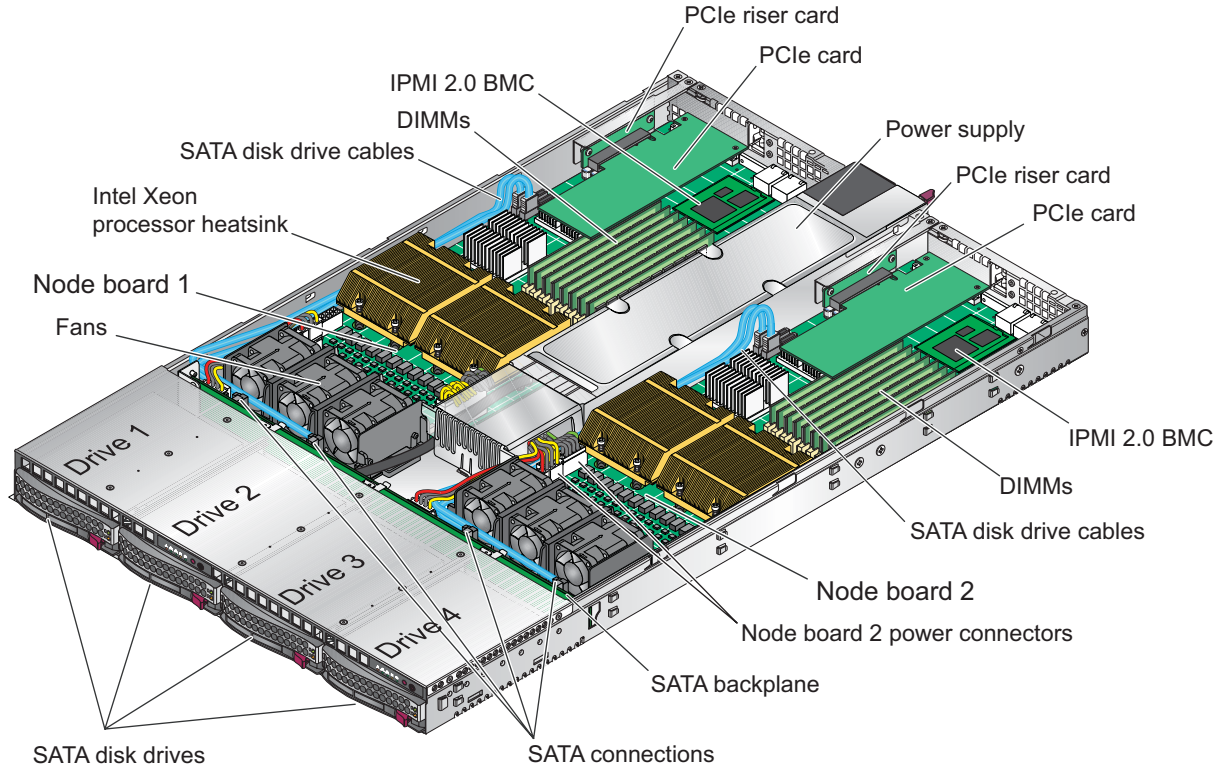

**Figure 1-2** Chassis Components

## Node Board Features

At the heart of the SGI Altix XE310 lies two dual-processor node boards, which are based on the Intel 5000P chipset (refer to Figure 1-3). Below are the main features of the node board.

---

**Note:** The features on each node board are doubled for the server (refer to Appendix D, “System Specifications”).

---

### Processors

Each node board supports two Intel Xeon quad-core processors.

### Memory

Each node board has eight 240-pin DIMM sockets (refer to Figure 1-2) that can support up to 32 GB of ECC fully buffered DIMM (FBDIMM) DDR2-667/533 SDRAM. Memory can be installed in both interleaved (dual-channel) and non-interleaved (single-channel) configurations. All memory modules used to populate the system should be the same size, type, and speed.

The node board memory controller supports memory mirroring to prevent data loss in case of DIMM failure. The system maintains two copies of all the data in memory; therefore, a mirrored system uses only half of the installed DIMMs. If a DIMM fails, the system recovers the second copy of data from the mirrored DIMM in the opposite channel. If both the primary and the mirrored copy of the data become corrupt, the system will fail. Configure memory mirroring with the Memory Branch Mode BIOS setting (refer to “Memory Branch Mode” on page 113).

### Serial ATA (SATA)

The southbridge (ESB2 chip) of the 5000P chipset includes a SATA controller for 3-Gb/s SATA drives. The hot-swappable SATA drives are connected to a backplane (refer to Figure 1-2) that provides power, bus termination, and configuration settings.



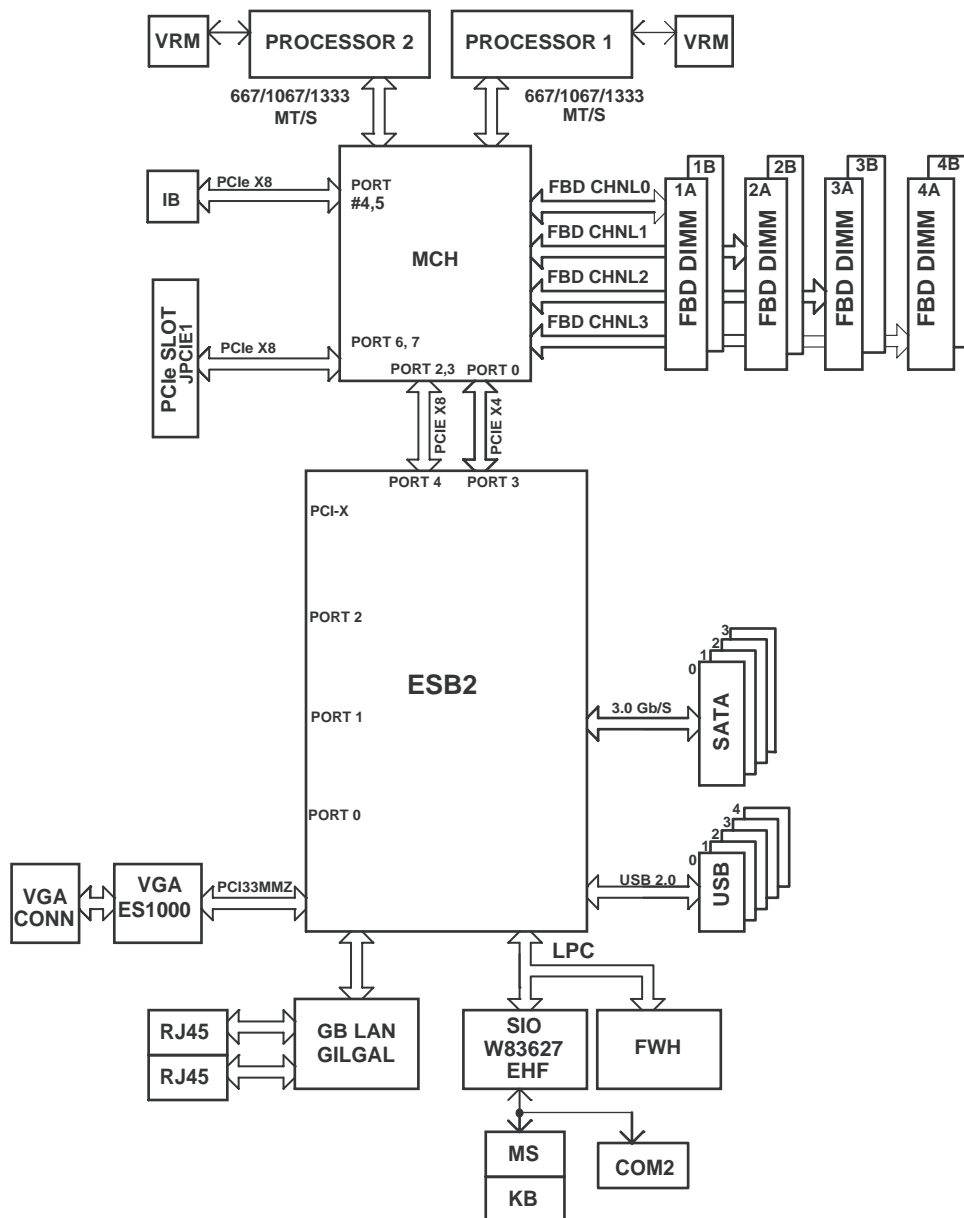

Figure 1-3 Node Board Block Diagram

## **Serial Attached SCSI (SAS) and RAID Support**

Appendix F, “Upgrading Your Server for SAS/RAID Support,” describes how to upgrade your server to use SAS hard drives as well as SATA hard drives by using model LSI SAS3041E HBAs. This HBA option also can provide support for RAID 0, RAID 1, or JBOD.

## **PCIe Expansion Slots**

Each node board supports one PCIe x8 slot. Two PCIe slots are available in the server chassis.

## **Ethernet Ports**

Two Intel 82563EB network controllers are integrated into the 5000P chipset on each of the node boards to support a total of four Gigabit LAN ports (100/1000 Base-T/1000 BaseTX, RJ45 output).

## **Onboard Controllers/Ports**

The node board IDE controller supports Ultra ATA 100 hard drives or ATAPI devices. Each node board I/O panel ports includes one COM port, a VGA port, two USB ports, two Gigabit Ethernet LAN (NIC) ports, and one optional InfiniBand® port.

## **ATI Graphics Controller**

The SGI Altix XE310 features an integrated ATI video controller based on the ES1000 graphics chip. The ES1000 was designed specifically for servers, featuring low-power consumption, high reliability, and superior longevity.

## **Other Features**

Other onboard features that enable reliable service include voltage monitors, auto-switching voltage regulators, chassis and CPU overheat sensors, virus protection, and BIOS rescue.

## Server Chassis Features

This section describes the main features of the SGI Altix XE310 1U chassis. Refer to Chapter 5, “Advanced Chassis Setup.” for more detailed information.

---

**Note:** For more detail on the chassis, refer to Chapter 5, “Advanced Chassis Setup.”

---

### System Power

A single power supply (refer to Figure 1-2) provides the power for both node boards. Each node board however, can be shut down independently of the other with the power button on its own control panel.

Although they share a common power supply, the I<sup>2</sup>C signals used for power supply monitoring are received by the node board 1 only. (When viewed from the front of the chassis, the node board on the left is node board 1 and the node board on the right is the node board 2.)

### SATA/SAS Backplane/Drives

As a system, the SGI Altix XE310 supports four SATA/SAS disk drives (refer to Figure 1-2). The SATA/SAS backplane is divided into two sections. A single power connector is used for the entire backplane, but other functions, such as circuit board overtemperature monitoring, apply to both sections. Each pair of disk drives is logically connected to its own node board. Consequently, the RAID configuration is limited to a two-drive scheme (RAID 1 or RAID 0). The RAID configuration cannot be set up across all four drives.

### System Security and Pre-Installed Linux Operating Systems

If your server was shipped with a pre-installed Linux<sup>®</sup> operating system, the password for `root` was set to `sgisgi` for your convenience. You should change this password at your earliest opportunity. Consult your Linux documentation for the procedure.



## Server Installation

This chapter provides a quick setup checklist to get the SGI Altix XE310 operational.

### Unpack the System

Inspect the shipping container that the SGI Altix XE310 was shipped in and note if it was damaged in any way. If the server shows damage, file a damage claim with the carrier who delivered it.

Decide on a suitable location for the rack that supports the weight, power requirements, and environmental requirements of the SGI Altix XE310 server. It should be situated in a clean, dust-free environment that is well ventilated. Avoid areas where heat, electrical noise, and electromagnetic fields are generated. Place the server rack near a grounded power outlet. Refer to “Warnings and Precautions” on page 10.

### Prepare for Setup

The shipping container should include two sets of rail assemblies, two rail mounting brackets and the mounting screws that you will use to install the system into a rack.

Read this section in its entirety before you begin the installation procedure.

### Choose a Setup Location

- Leave enough clearance in front of the rack to enable you to open the front door completely, approximately 25 in. (65 cm).
- Leave approximately 30 in. (76 cm) of clearance in the back of the rack to allow for sufficient airflow and ease in servicing.

## Warnings and Precautions

### Rack Precautions



---

**Warning:** The SGI Altix XE310 server weighs 40 lb (18 kg). Always use proper lifting techniques when you move the server. Always get the assistance of another qualified person when you install the sever in a location above your shoulders. Failure to do so may result in serious personal injury or damage to the equipment.

---



---

**Warning:** Extend the leveling jacks on the bottom of the rack to the floor with the full weight of the rack resting on them. Failure to do so can result in serious injury or death.

---



---

**Warning:** Attach stabilizers to the rack in single rack installations. Failure to do so can result in serious injury or death.

---



---

**Warning:** Couple racks together in multiple rack installations. Failure to do so can result in serious injury or death.

---



---

**Warning:** Be sure the rack is stable before extending a component from the rack. Failure to do so can result in serious injury or death.

---



---

**Warning:** Extend only one component at a time. Extending two or more components simultaneously may cause the rack to tip over and result in serious injury or death.

---

## Server Precautions

- Review the electrical and general safety precautions in Appendix E, “System Safety.”
- Determine the placement of each component in the rack before you install the rails.
- Install the heaviest server components in the bottom of the rack first, and then work up.
- Use a regulating uninterruptible power supply (UPS) to protect the server from power surges and voltage spikes and to keep your system operating in case of a power failure.
- Allow the hot plug SATA drives and power supply modules to cool before touching them.
- Always keep the rack’s front door and all panels and components on the servers closed when not servicing to maintain proper cooling.

## Rack Mounting Considerations

### Ambient Operating Temperature

If installed in a closed or multi-unit rack assembly, the ambient operating temperature of the rack environment may be greater than the ambient temperature of the room. Therefore, consideration should be given to installing the equipment in an environment compatible with the manufacturer’s maximum rated ambient temperature (35° C or 95° F). Refer to Appendix D, “System Specifications” for information.

### Reduced Airflow

Equipment should be mounted into a rack so that the amount of airflow required for safe operation is not compromised.

### Mechanical Loading

Equipment should be mounted into a rack so that a hazardous condition does not arise due to uneven mechanical loading.

## **Circuit Overloading**

Consideration should be given to the connection of the equipment to the power supply circuitry and the effect that any possible overloading of circuits might have on overcurrent protection and power supply wiring. Appropriate consideration of equipment nameplate ratings should be used when addressing this concern.

## **Reliable Ground**

A reliable ground must be maintained at all times. To ensure this, the rack itself should be grounded. Particular attention should be given to power supply connections other than the direct connections to the branch circuit (i.e. the use of power strips, etc.).

## **Install the System into a Rack**

This section provides information on installing the SGI Altix XE310 into a rack unit with the rack rails provided. If the system has already been mounted into a rack, refer to “Check the Node Board Setup” on page 22. There are a variety of rack units on the market, which may mean the assembly procedure will differ slightly. You should also refer to the installation instructions that came with the rack unit you are using.

## **Identify the Sections of the Rack Rails**

You should have received two rack rail assemblies in the rack mounting kit. Each assembly consists of two sections: an inner fixed chassis rail that secures directly to the server chassis and an outer fixed rack rail that secures directly to the rack itself (refer to Figure 2-1). Two pairs of short brackets to be used on the front side of the outer rails are also included.



## Install the Rails

Perform the following procedure to install the inner rails:

1. If both the left and right side inner rails (refer to Figure 2-1) have not been pre-attached to the chassis, refer to Figure 2-6 on page 16. Figure 2-6 shows how the inner rails are attached to the server chassis.

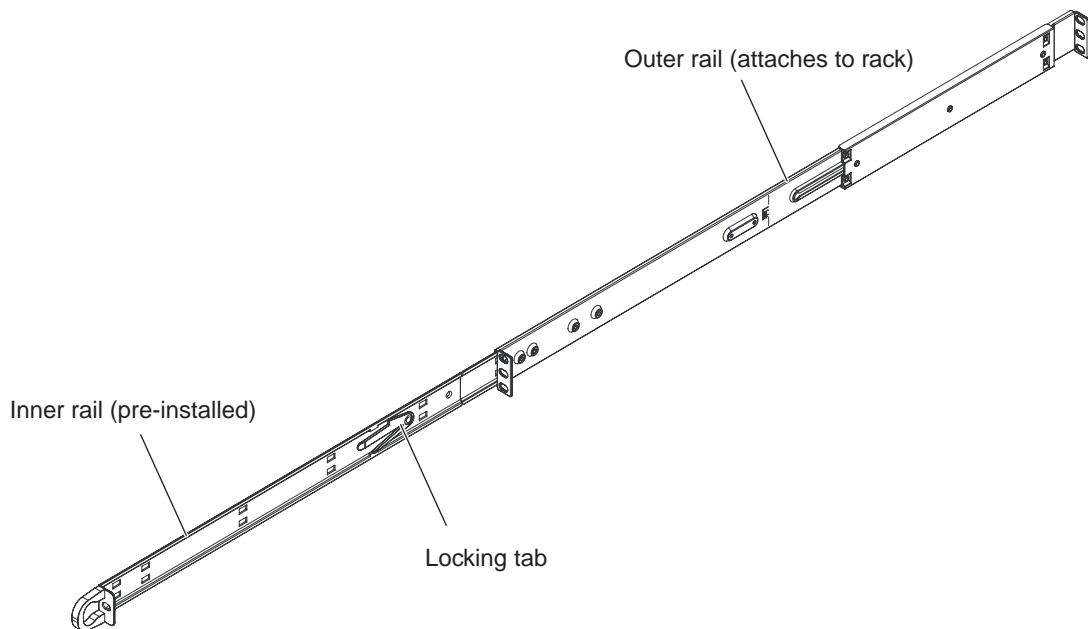

**Figure 2-1** Identify Sections of the Rack Rails (right side rail shown)

2. Assemble one of the rails that attaches to the rack. (Refer to Figure 2-2.)



**Figure 2-2** Rail Assembly

3. Install two screws to attach the inner bracket to the front of the rail. (Refer to Figure 2-3.)



**Figure 2-3** Attaching the Inner Bracket

4. Attach the rail to the front of the rack chassis (refer to Figure 2-4):
  - a. Slide the front brackets over the appropriate holes in the rack frame.

---

**Note:** The frame of the rack fits between the two brackets on front of the rail.

---

- b. Install the upper and lower screws to attach the rail to the rack.

---

**Note:** The middle hole remains empty. You will install a screw into this hole to secure the server to the front of the rack.

---

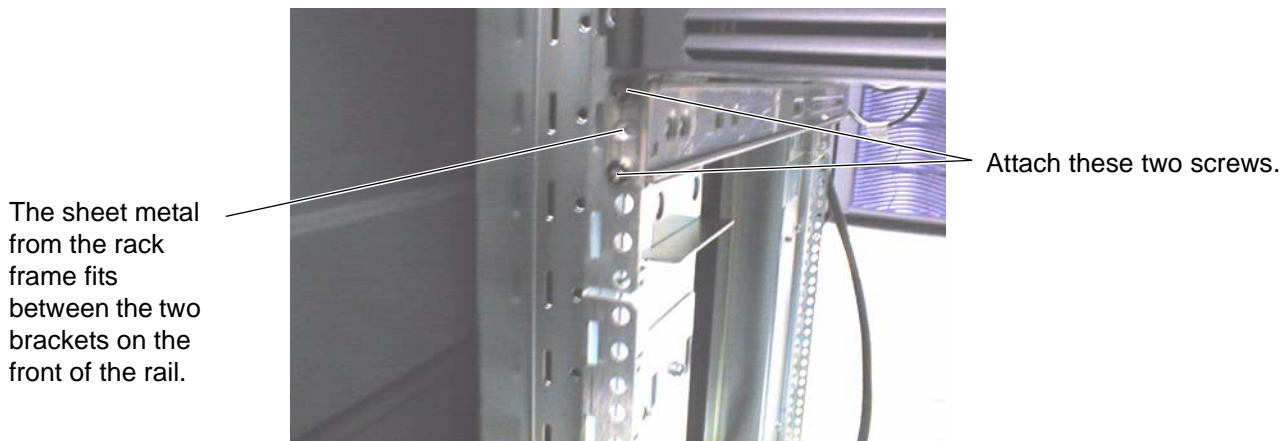

**Figure 2-4** Attaching the Rail to the Front of the Rack (View from Front of Rack)

5. Attach the rail to the rear of the chassis (refer to Figure 2-5):
  - a. Slide two clips (rail nuts) over the appropriate holes in the rack frame.
  - b. Position the rail over the rack chassis (in front of the rail clips/nuts) and align to the proper position.
  - c. Install two screws through the holes in the rail. The screws fasten into the two rail clips/nuts that you previously installed.
6. Repeat Steps 1 through 5 to install the other rail in the rack.

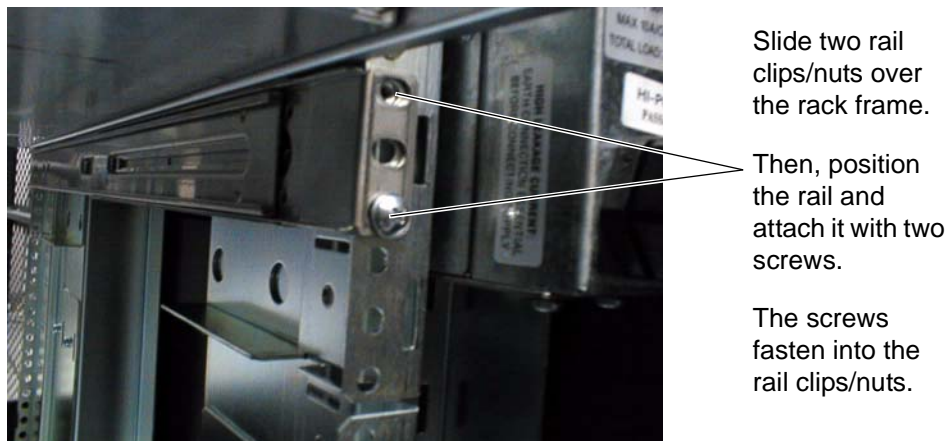

**Figure 2-5** Attaching the Rail to the Rear of the Rack (View from Rear of Rack)

## Locking Tabs

Both chassis rails have a locking tab (refer to Figure 2-6), which serves two functions: the first is to lock the server into place when it is installed in the rack; the second is to lock the server in place when it is fully extended from the rack. The locking tab prevents the server from being removed from the rack accidentally when you pull it out for service.

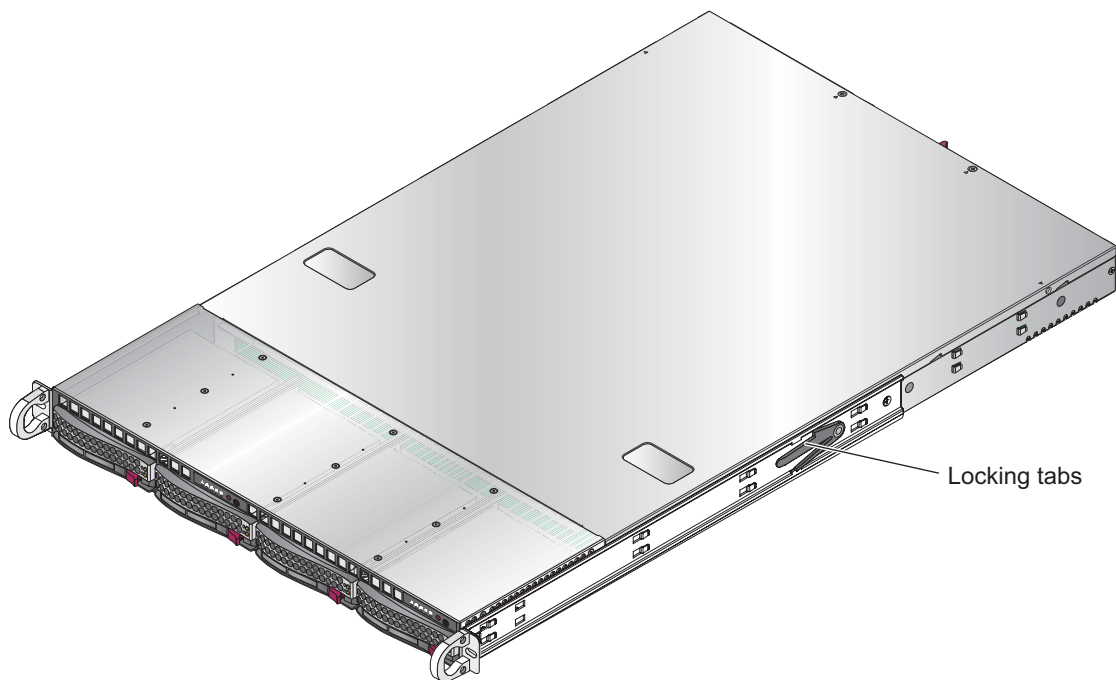

**Figure 2-6** Install the Rack Rails

## Install the Server in a Rack



---

**Warning:** The SGI Altix XE310 server weighs 40 lb (18 kg). Always use proper lifting techniques when you move the server. Always get the assistance of another qualified person when you install the sever in a location above your shoulders. Failure to do so may result in serious personal injury or damage to the equipment.

---

You should now have rails attached to both the server chassis and the rack unit. The next step is to install the server into the rack (refer to Figure 2-7).

1. Line up the rear of the chassis rails with the front of the rack rails.
2. Slide the server chassis rails into the rack rails, keeping the pressure even on both sides (you may have to depress the locking tabs when inserting).
3. When the server has been pushed completely into the rack, you should hear the locking tabs “click.”
4. Install and tighten two screws to secure the server to the rack.

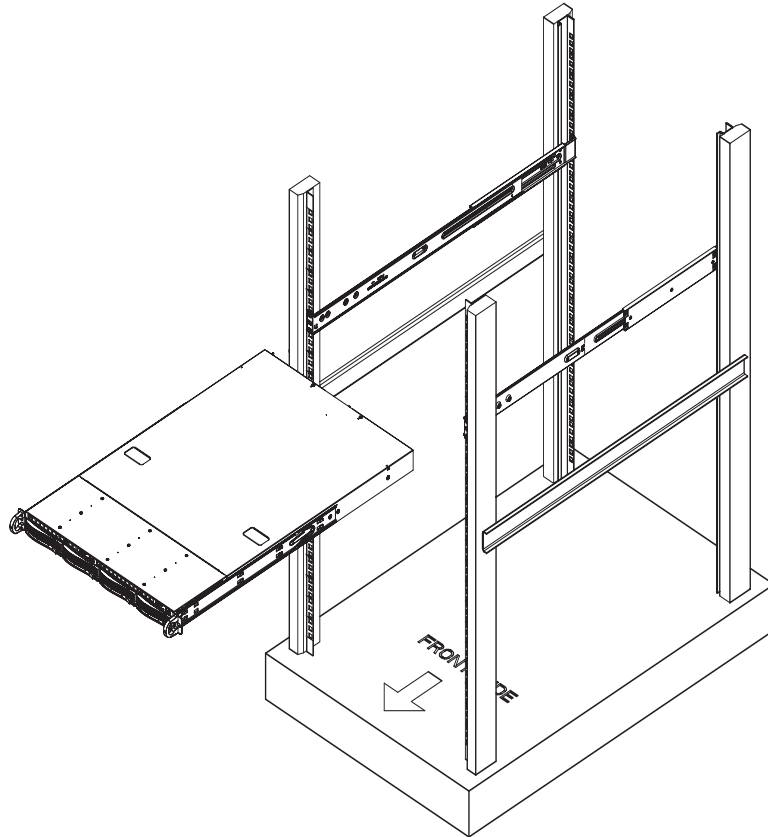

**Figure 2-7** Install the Server in a Rack

## Install the Server in a Third-party Rack



**Warning:** The SGI Altix XE310 server weighs 40 lb (18 kg). Always use proper lifting techniques when you move the server. Always get the assistance of another qualified person when you install the sever in a location above your shoulders. Failure to do so may result in serious personal injury or damage to the equipment.

1. Slide the server onto the outer rack rails (refer to Figure 2-8).

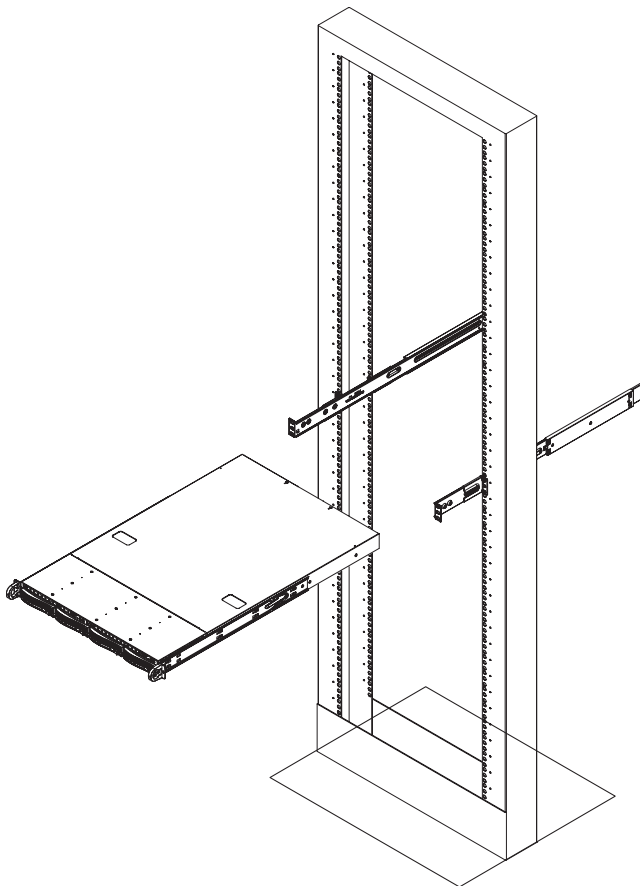

**Figure 2-8** Install the Server in a Third-party Rack (1)

- Using three screws each, attach the outer rail assembly onto the right angle brackets.

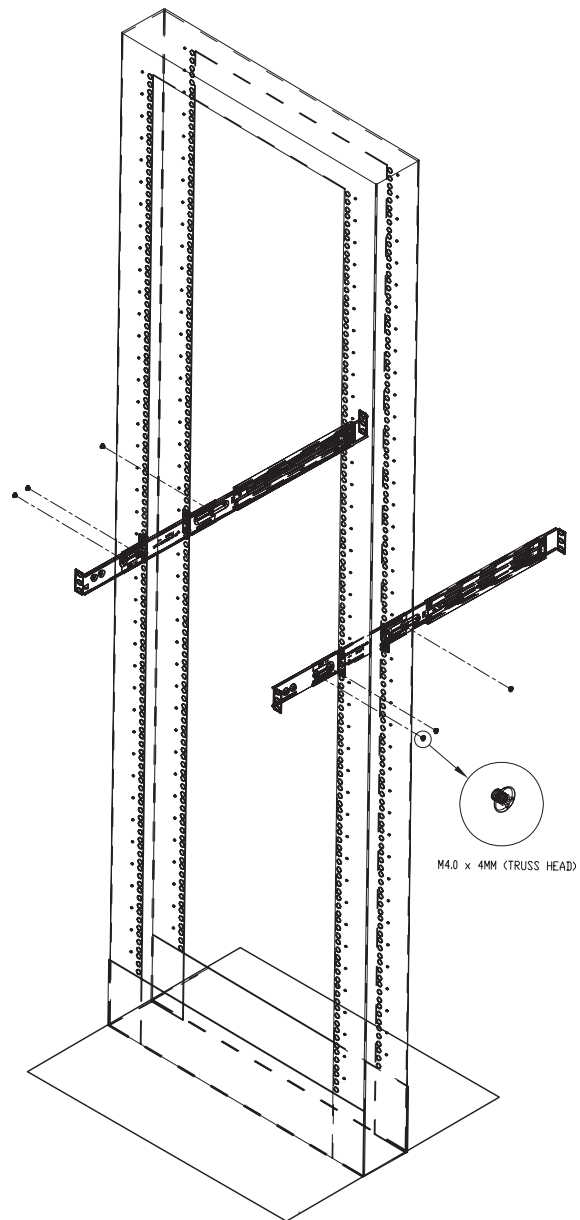

**Figure 2-9** Install the Server in a Third-party Rack (2)



3. Install the right angle brackets onto the two-post rack, using two screws on each end.

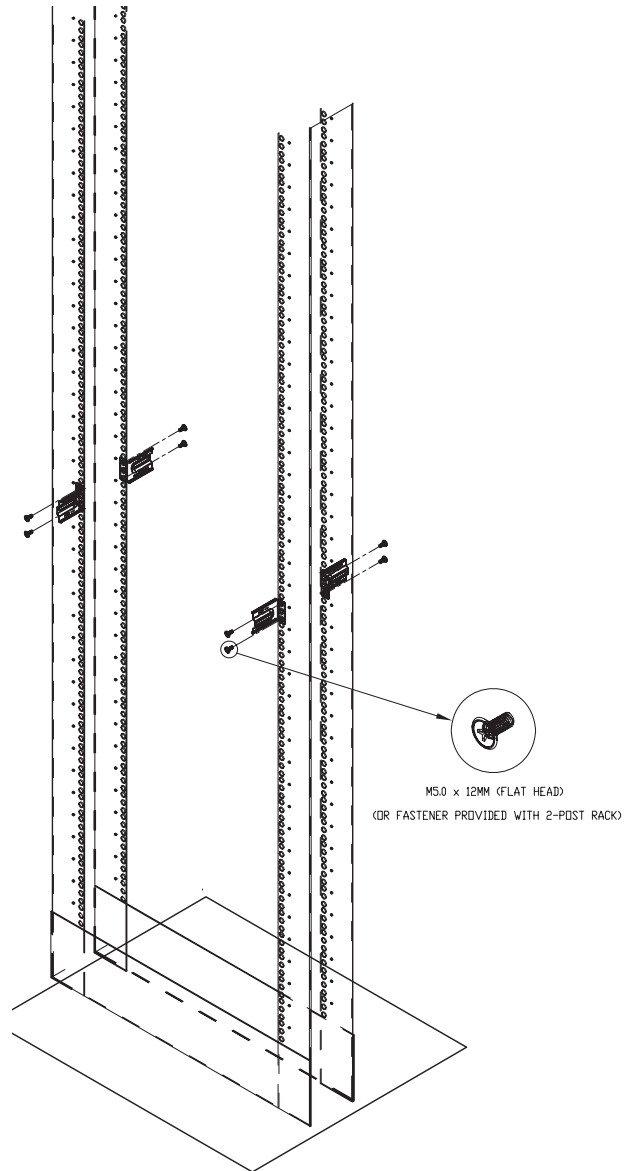

**Figure 2-10** Install the Server in a Third-party Rack (3)

## Check the Node Board Setup

Use the following sections to open the top cover and check that each node board is properly installed and all the connections have been made.

### Access the Inside of the Chassis

Refer to Figure 2-11 when using the following procedure.

1. Remove the screws that secure the system to the rack.
2. Grasp the two handles on either side and pull the system straight out until it locks (you will hear a “click”).
3. Press the locking tabs to release the system from the rack and place it on a stable ESD-safe work surface.
4. Remove the rack rails (Figure 2-6) from the chassis so that you can gain access to the top cover screws.
5. Remove the four screws (two on the sides and two on the top) that secure the top cover to the chassis.
6. Place your thumbs in the two rectangular recesses and push the cover away from you (toward the rear of the chassis) until it stops.
7. Lift the top cover from the chassis to gain access to the inside of the server.

---

**Note:** To remove the system from the rack completely, depress the locking tabs in the chassis rails (push the right-side tab down and the left-side tab up) to continue to pull the system out past the locked position.

---

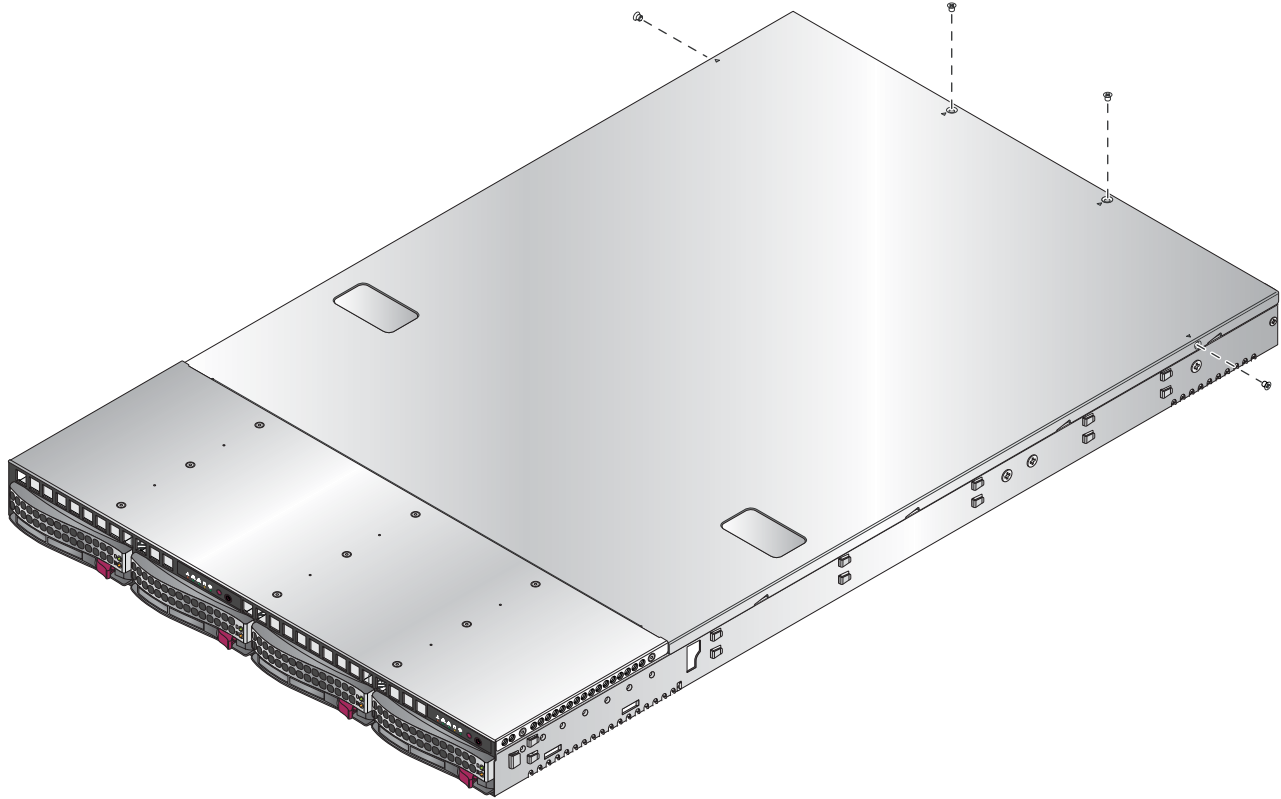

**Figure 2-11** Remove the Top Cover

## Check the CPUs (processors)

You may have one or two processors installed on each node board. Each processor needs its own heatsink. Refer to Chapter 4, “Advanced Node Board Setup,” for instructions on how to install processors and heatsinks.

## Check the System Memory

Your server system is shipped with system memory installed. Make sure all DIMMs are fully seated in their slots. For details on adding system memory, refer to Chapter 4.

## Install Expansion PCIe Cards

You can install two expansion PCIe cards in the system. Refer to Chapter 4 for details on installing PCIe expansion cards.

## Check all Cable Connections and Airflow

Make sure all power and data cables are properly connected and not blocking the chassis airflow. Refer to Chapter 4 for details on cable connections.

## Check the Drive Bay Setup

Next, you should check to make sure the SATA/SAS drives and SATA/SAS backplane have been properly installed and all connections have been made.

## Check the SATA/SAS Drives

Depending upon your system configuration, your system may have one or more drives installed. For detailed information about how to install SATA/SAS drives, refer to Chapter 5, “Advanced Chassis Setup.”

## Check the Airflow

Airflow is provided by six sets of 4-cm fans (each set of fans consists of two fans that are mounted back to back). The system component layout was carefully designed to direct sufficient airflow to cool the components that generate the most heat. Note that all power and data cables have been routed in such a way that they do not block the airflow generated by the fans. An air shroud is also installed to focus the airflow to areas where the most heat is generated.

## Supply Power to the System

If necessary, install the system in a rack (refer to “Install the System into a Rack” on page 12), and connect the power cord from the power supply module into a power strip or power distribution unit (PDU). The PDU offers protection from electrical noise and power surges. SGI also recommends that you use an uninterruptible power supply (UPS) source.

## Controls and Indicators

This chapter describes the functions of the controls and indicators (light emitting diodes, or LEDs) on the SGI Altix XE310 server. There are several LEDs on the two control panels (refer to Figure 3-1) as well as others on the SATA drive carriers that inform you of the overall system status, as well as the activity and status of specific components. There are also two switches (buttons) on each control panel.

---

**Note:** The server has two control panels, one for each node board installed in the system. This allows each node board to be controlled independently of the other.

---

### Controls

There are two push-button switches located on each control panel: a reset switch and a power on/off switch (refer to Figure 3-1).

- **RESET:** Press the reset button to reboot only the node board controlled by that control panel.
- **POWER:** Press power button to apply or remove power only to the node board controlled by that control panel. Pressing this button removes the main power but keeps standby power supplied to the node board.

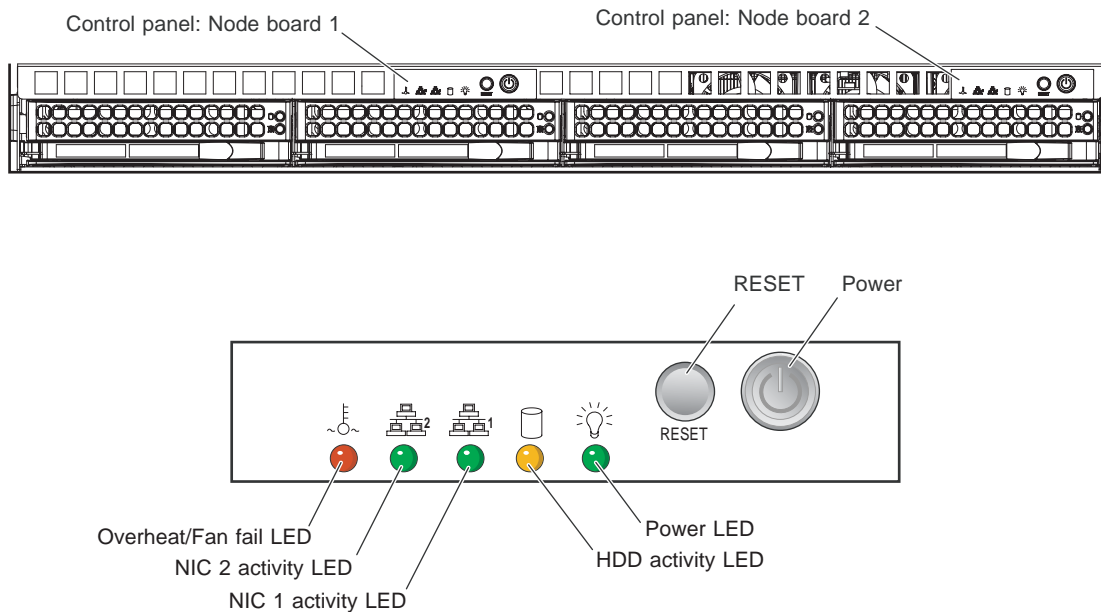

**Figure 3-1** Front Panel Controls and Indicators

## Indicators

Each control panel is located on the front of the SGI Altix XE310 system and has five LED indicators (refer to Figure 3-1). Each LED provides you with critical information related to its own specific node board.

The following items explain the node board LED indicators and the corrective action that you should take when the LED illuminates:

- **Overheat/Fan fail:** When the Overheat/Fan Fail LED flashes, it indicates that a fan has failed. When the Overheat/Fan Fail LED is on continuously, it indicates that an overheat condition has occurred, which may be caused by cables obstructing the airflow in the system or the ambient room temperature being too warm.

**Note:** Check the routing of the cables and make sure all fans are present and operating normally. Check that the chassis covers are installed properly.

Verify that the processor heatsinks are installed properly (refer to Chapter 4). Verify that the overhead/fan fail LED remains flashing. It will remain flashing as long as the overheated or fan fail condition exists.

---

- **NIC2:** Indicates network activity on LAN2 when flashing.
- **NIC1:** Indicates network activity on LAN1 when flashing.
- **HDD:** Channel activity for the hard disk drive (HDD). This light indicates SATA drive activity on the node board when flashing.
- **Power:** Indicates power is being supplied to the system's power supply unit. This LED should normally be illuminated when the system is operating.

## SATA Drive Carrier Indicators

Each SATA drive carrier has two LED indicators.

- **Green**
  - When illuminated, the green LED on the front of the SATA drive carrier indicates drive activity. A connection to the SATA backplane enables this LED to blink on and off when that particular drive is being accessed.
- **Red**
  - The red LED indicates two states. When blinking, it indicates the drive is rebuilding. When solid, it indicates a drive failure.
  - If a SATA drive fails, you should be notified by your system management software. Refer to Chapter 5 for instructions about how to replace a failed SATA disk drive.





## Advanced Node Board Setup

This chapter includes procedures to install a node board into the SGI Altix XE310 chassis, connect the data and power cables, and install expansion cards. All node board jumpers and connections are also discussed.

A layout and quick reference chart is included in this chapter for your reference.

---

**Note:** *Some software products are protected with software license keys derived from the Media Access Control (MAC) ethernet address. When you replace a node board, the MAC ethernet address changes. If you are using such a product, you must request a new license key after replacing the node board. Contact your local customer support office:*

*<http://www.sgi.com/support/supportcenters.html>*

---



---

**Caution:** Install the chassis cover after you have completed accessing the components inside the server to maintain proper airflow and cooling for the system.

---

## Handling the Node Board



---

**Caution:** Electrostatic discharge (ESD) can damage electrostatic-sensitive devices inside the SGI Altix XE310 server. Use the ESD precautions described below when you handle printed circuit boards or other components in the system. To prevent the node board from bending, keep one hand under the center of the board to support it when handling it. The following measures are generally sufficient to protect your equipment from electric static discharge.

---

## ESD Precautions

- Use a grounded wrist strap designed to prevent electrostatic discharge.
- Touch a grounded metal object before removing any board from its antistatic bag.
- Handle each printed circuit board (PCB) by the edges; do not touch the components, peripheral chips, memory modules, or gold contacts on the PCB.
- When handling chips or modules, avoid touching the pins.
- Place the node board, expansion PCI cards, or other boards and components into antistatic bags when not in use.
- Make sure your computer chassis provides a conductive path between the power supply, the case, the mounting fasteners, and the node board to chassis ground.

## Unpacking



---

**Caution:** The node board is shipped in antistatic packaging to avoid electrostatic discharge damage. Be sure to use ESD precautions when you unpack replacement components for the SGI Altix XE310 server. Failure to do so can result in damage to the equipment.

---

## Node Board Installation

This section explains how to mount the node board into the SGI Altix XE310 chassis. To remove the node board, follow this procedure in reverse order.

1. Access the inside of the system (refer to Figure 4-1):
  - a. Remove the rack rails so that you can gain access to the top cover screws.
  - b. The top cover of the chassis is secured with four screws: two at the top rear of the cover and one on each side lip, also near the back. Remove all four screws, then place both thumbs in the indentations and push the cover back until it slides off. You can then lift the top cover from the chassis to gain full access to the inside of the server.

---

**Note:** If already installed in a rack, you must first release the retention screws that secure the unit to the rack. Then grasp the two handles on either side and pull the unit straight out until the rails lock into place.)

---

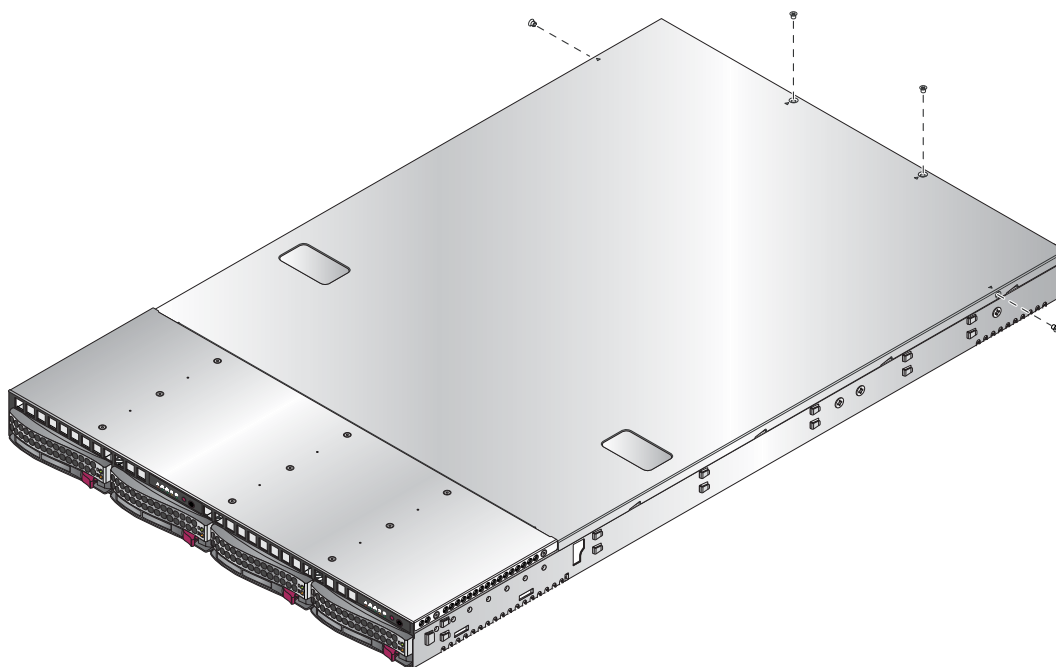

**Figure 4-1** Remove the Top Cover

2. Check compatibility of node board ports and I/O shield:

---

**Note:** Make sure that the I/O ports on the node boards align properly with their respective holes in the I/O shield on the back of the SGI Altix XE310 chassis.

---

3. Remove the PCI card riser card and bracket.
4. Mount the node board onto the node board tray:
  - a. Carefully mount the node boards by aligning the board holes with the raised metal standoffs that are visible in the chassis (refer to Figure 4-2).



---

**Caution:** Do not overtighten the screws in step b. Overtightening the screws will damage the equipment.

---

- b. Install 5 screws into all the mounting holes on the node board that line up with the standoffs and tighten until snug. The metal screws provide an electrical contact to the node board ground to provide a continuous ground for the system.
5. Install the PCI riser card and bracket.

## Connect the Power Cables

A node board has two 20-pin ATX power supply connectors (refer to Figure 4-2) that can be connected to the ATX power supply. Only one of these connectors is used when the node board is installed in the chassis. Each node board also provide a 4-pin auxiliary power connector used to connect disk drive power to the SATA backplane.

For the node board 1 (installed on the left side of the chassis):

1. Connect the power cable to the primary ATX power header on the right side of the node board.
2. Connect the auxiliary power cable to the power connector on left side of the SATA backplane.

For node board 2 (installed on the right side of the chassis):

1. Connect the power cable to the secondary ATX power header on the left side of the node board.
2. Connect the auxiliary power cable to the power connector on right side of the SATA backplane.

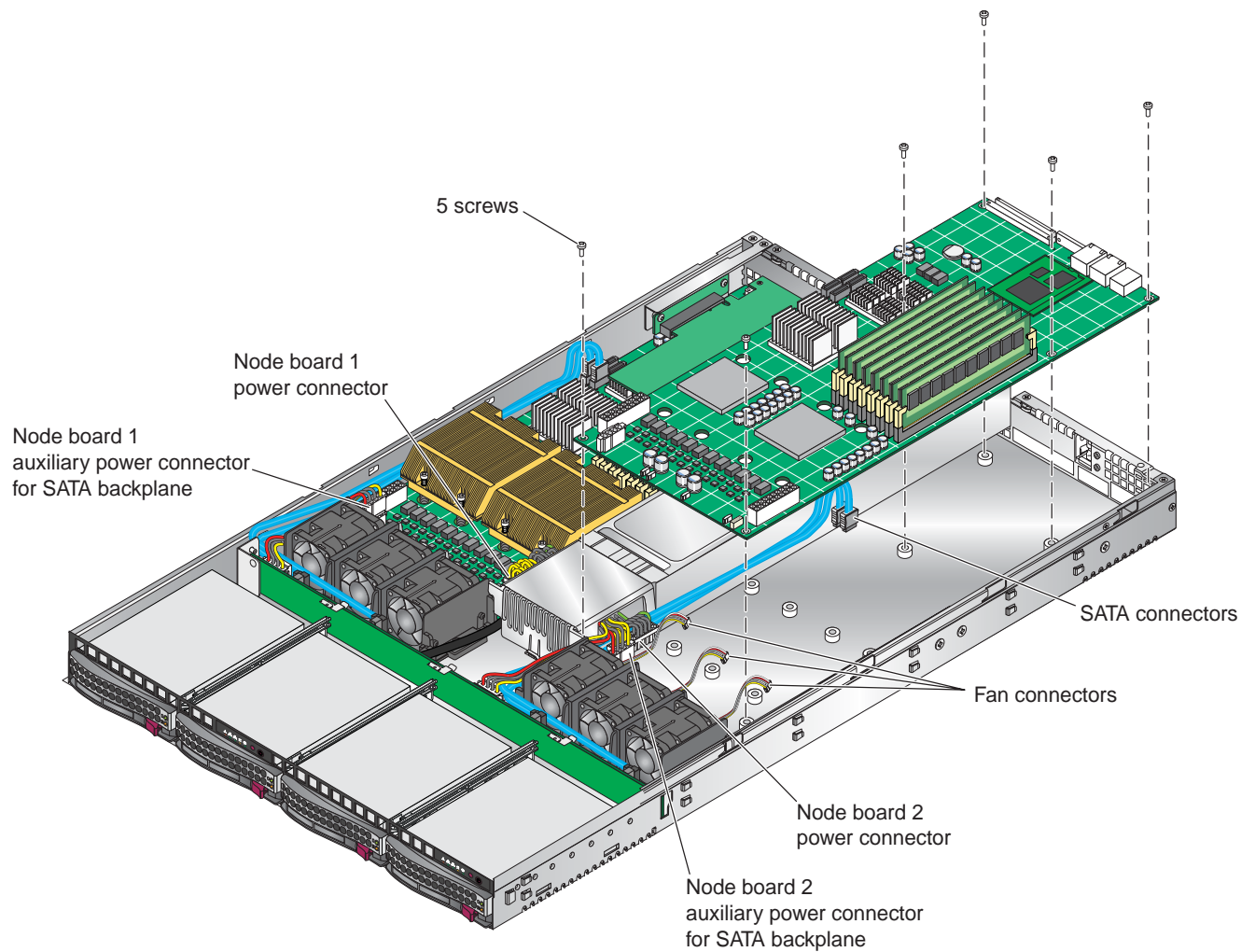
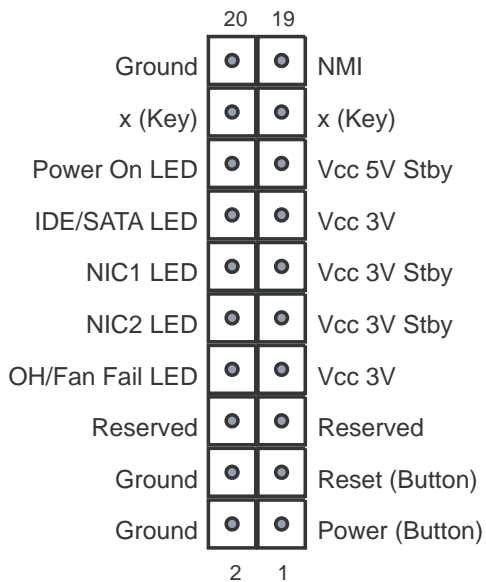

**Figure 4-2** Node Board Installation

## Connecting the Control Panel

The JF1 connector (refer to Figure 4-3) contains header pins for various front control panel connectors, switches, and LED indicators.

All of the JF1 connector wires are bundled into a single ribbon cable to simplify this connection. Make sure the red wire plugs into pin 1 as marked on the board. The other end connects to the control panel PCB, located just behind the system status LEDs on the chassis.



**Figure 4-3** Control Panel Connector (JF1) Pin Definitions

## I/O Ports

The I/O ports are color coded. Figure 4-4 shows the color and location of the various I/O ports on the I/O panel.

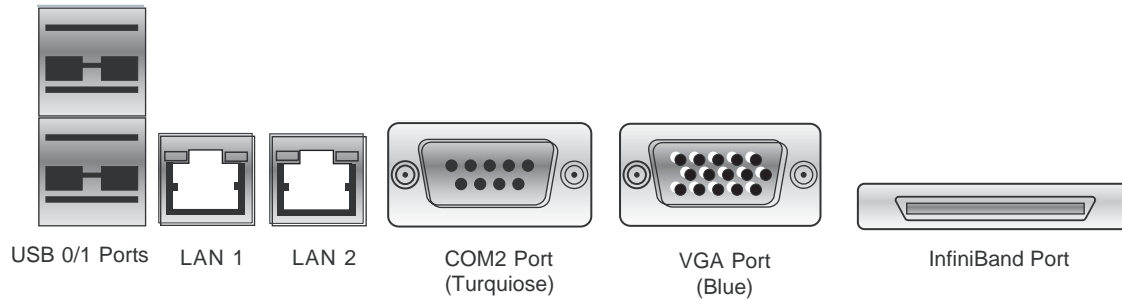

**Figure 4-4** I/O Port Locations

## Processor and Heatsink Installation and Removal



**Caution:** When handling the processor, avoid placing direct pressure on the label area of the fan.



**Caution:** Do not place the node board on a conductive surface. A conductive surface can damage the BIOS battery and prevent the system from booting. Always place the node board on an ESD-safe worksurface.



**Caution:** Always disconnect the power before adding, removing or changing any hardware components. Make sure that you install the processor into the CPU socket before you install the heatsink and fan. The node board can support either one or two processors. If installing one processor only, install it into CPU socket 2. The DIMMs run significantly cooler using socket 2 rather than socket 1.

---

**Note:** SGI's replacement Xeon CPU package contains a heatsink assembly. Make sure that the black pick-and-place (PnP) cap is in place; otherwise, contact the SGI immediately.

---

---

**Important!:** When you install only a single CPU on each node board, install the single CPU in socket 2 (refer to Figure 4-11 on page 58) on both node boards. Install the air shroud in accordance with “Install or Remove the Air Shroud” on page 57.

---

## Install a Processor

---

**Note:** A black pick-and-place (PnP) cap is attached to the load plate to protect the CPU socket.

---

1. Press the load lever down and away from the retention clasp to release the load plate from its locked position.

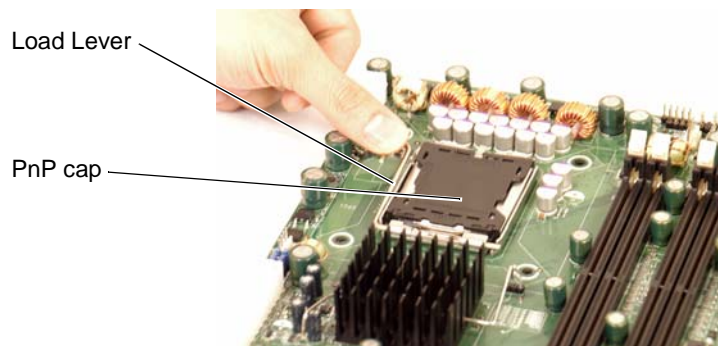



2. Gently lift the load lever to open the load plate.

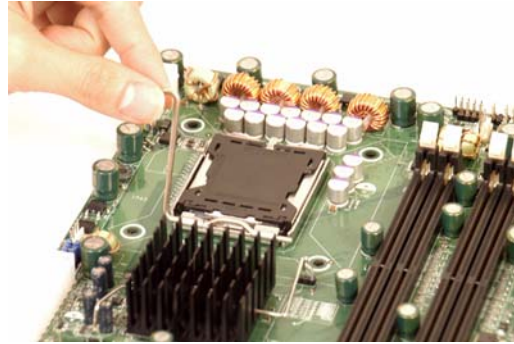

Load plate  
released

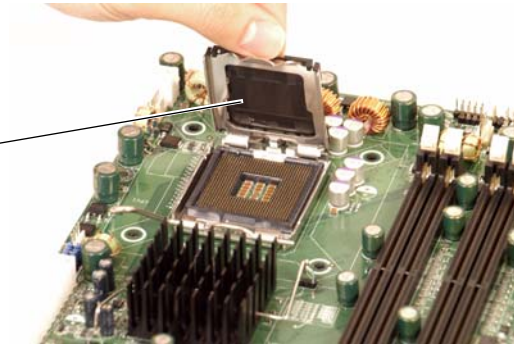

3. Use your thumb and your index finger to hold the CPU at opposite sides.

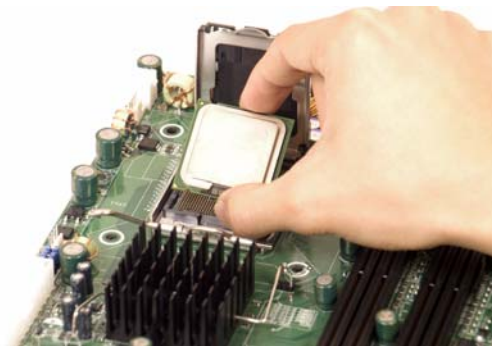

4. Align pin 1 of the CPU (the corner marked with a triangle) with the notched corner of the CPU socket.



---

**Caution:** In step 5, do not drop the CPU on the socket. Do not move the CPU horizontally or vertically, and do not rub the CPU against any surface or any of the contacts which may damage the CPU and/or contacts.

---

5. Once aligned, carefully lower the CPU straight down into the socket.
6. Find the corner of the CPU that has a semi-circle cutout below a gold dot (CPU key). This corner should be aligned with the cutout on the socket (socket key).

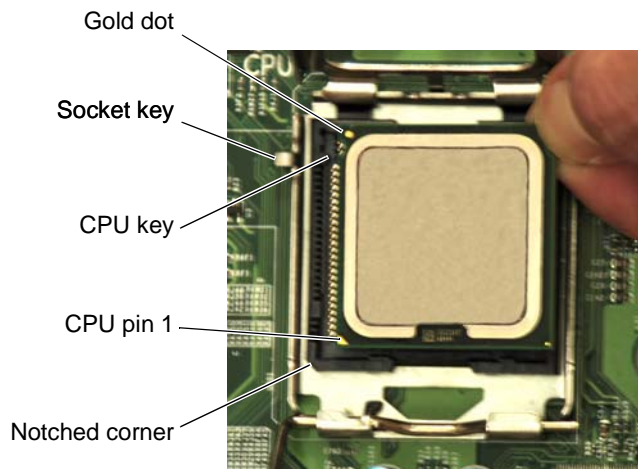

7. With the CPU in the socket, inspect the four corners of the CPU to make sure that it is properly installed.

8. Use your thumb to gently push the load lever down until it snaps into the retention clasp.

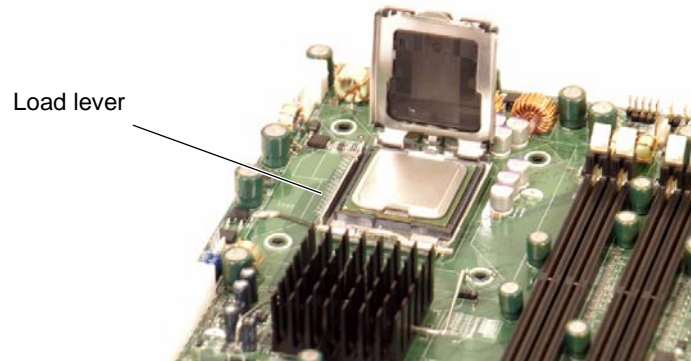

9. If the CPU is properly installed into the socket, the PnP cap is automatically released from the load plate when the lever locks.



---

**Caution:** Retain the plastic PnP cap for shipping. The node board must be shipped with the PnP cap properly installed to protect the CPU socket. Shipment without the PnP cap properly installed may void the warranty.

---

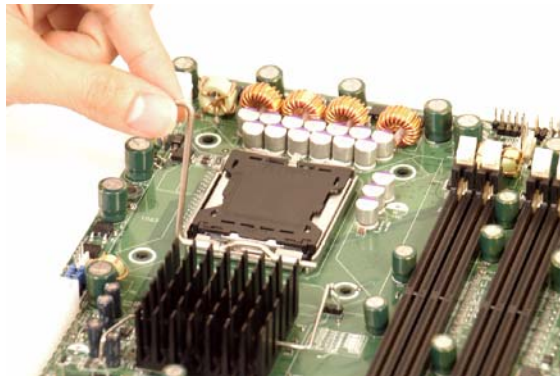

10. Remove the PnP cap.

PnP cap released  
from load plate

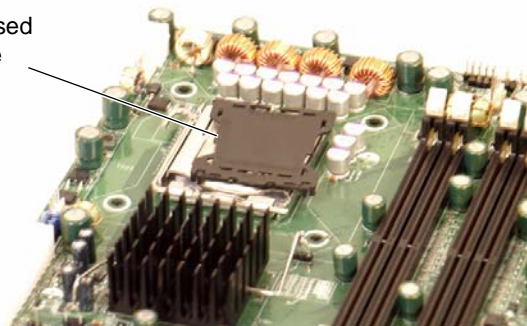

11. Repeat these steps to install a second CPU if desired.

## Install a Heatsink

1. Ensure that you have replaced the thermal interface material (TIM) between the heatsink and the CPU die.

Refer to section “Replace the Thermal Interface Material” on page 42.



---

**Caution:** Use caution when you unpack the heat sink so you do not damage the TIM.

---

2. Place the heatsink on top of the CPU so that the four mounting holes are aligned with those on the (preinstalled) heatsink retention mechanism.



---

**Caution:** Do not tighten the screws in step 3 or you may damage the CPU.

---

3. Install two screws (screw 1 and screw 2, shown in Figure 4-5) and tighten until just snug.



---

**Caution:** Do not overtighten the screws in step 4 or you may damage the CPU.

---

4. Install the two remaining screws (screw 3 and screw 4, shown in Figure 4-5); then, gently tighten all four screws.

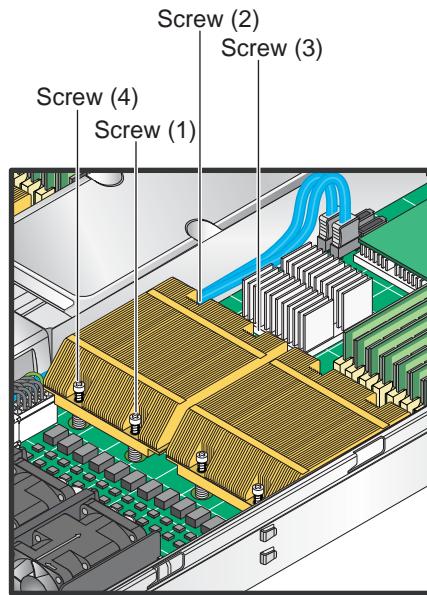

**Figure 4-5** Install a CPU Heatsink

## Remove the Heatsink

SGI does not recommend that the CPU or the heatsink be removed from the node board. However, if you do need to remove the heatsink, use the instructions below to prevent damage to the CPU or the CPU socket.

1. Unscrew and remove the heatsink screws from the node board in the sequence as shown in Figure 4-5.



**Caution:** Do not use excessive force when loosening the heatsink. Using excessive force can damage the heatsink, CPU, or node board.

2. Grasp the heatsink and gently loosen it from the CPU.
3. When the heatsink is loose, remove it from the CPU.
4. Clean the surface of the CPU and the heatsink to remove the old thermal grease.

Refer to section “Replace the Thermal Interface Material” on page 42.

5. Apply a small amount of thermal interface material (TIM) on the surface of the CPU before you install the heatsink.

## Replace the Thermal Interface Material

The Intel Xeon processors used in your server require a thermal interface material (TIM) between the processors and heatsinks to properly dissipate the heat that is generated by the processors. If you replace a processor and/or heatsink, you will need to remove the existing TIM from the processor and heatsink. Then, you will need to apply new TIM to the processor before you install the heatsink.

The TIM application instructions accompany the new TIM. The following subsections describe how to remove the existing TIM:

- “Removing TIM from a Processor” on page 42
- “Removing TIM from a Heatsink” on page 46

### Removing TIM from a Processor

You should always remove the TIM from a processor before you remove it from the node board.

---

**Warning:** Always wear gloves when performing this procedure to avoid direct skin contact with the TIM, which is a potentially toxic material.

---

#### Tools/Parts Required:

- Dry, lint-free cloth
- Lint-free cloth moistened with isopropyl alcohol
- Gloves

---

**Caution:** To prevent the processor from moving in its socket, ensure that the processor load lever remains engaged while you perform the following procedure. If the processor moves while you remove the TIM, the pins on the processor might be damaged.

---

Perform the following steps to remove the TIM from a processor:

1. Remove the heatsink from the socket.

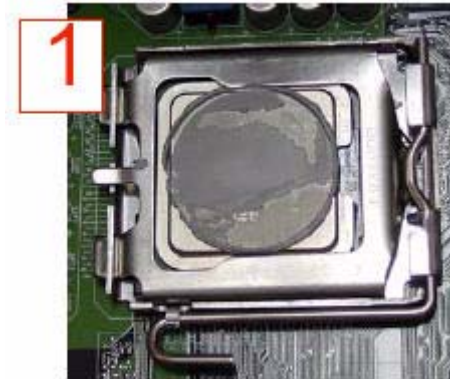

---

**Note:** If you plan to re-use the heatsink with a replacement processor, you must clean the TIM off of the heatsink. (Refer to “Removing TIM from a Heatsink” on page 46.)

---

2. Gently push any loose TIM pieces to the center of the processor.



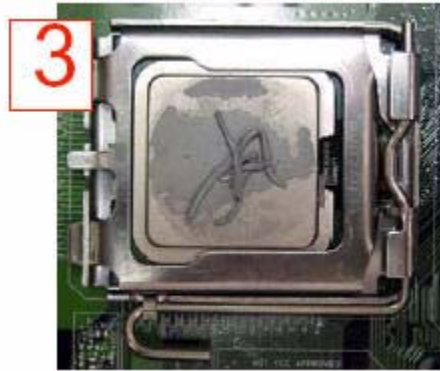

3. Use a dry lint-free cloth to lift the loose TIM pieces off of the processor.





4. Use a dry, lint-free cloth to wipe any remaining TIM pieces off of the processor.

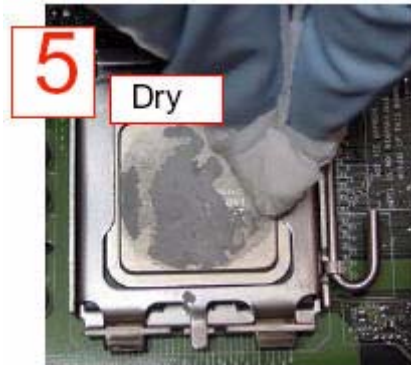

5. Use a different lint-free cloth moistened with isopropyl alcohol (IPA) to remove any remaining TIM from the processor.

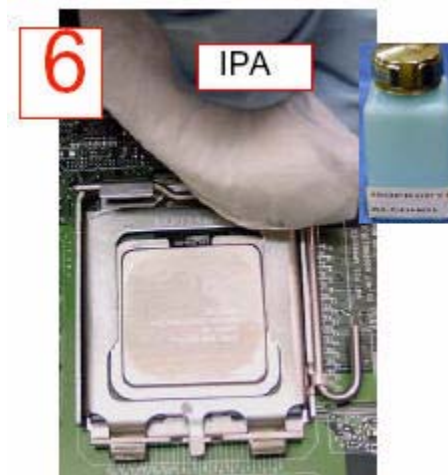

---

**Note:** Be sure to remove TIM from the gaps between the processor and the load plate.

---

### Removing TIM from a Heatsink

If you plan re-use the heatsink with a replacement processor, you need to remove the TIM from the heatsink.

---

**Warning:** Always wear gloves when performing this procedure to avoid direct skin contact with the TIM, which is a potentially toxic material.

---

#### Tools/Parts Required:

- Dry, lint-free cloth
- Lint-free cloth moistened with isopropyl alcohol
- Gloves

Perform the following steps to remove the TIM from a heatsink:

1. Remove the heatsink from the socket and place the heatsink on a secure surface with the bottom facing upward.

2. Use a dry, lint-free cloth to wipe any loose TIM pieces off of the heatsink.



3. Use a different lint-free cloth moistened with isopropyl alcohol (IPA) to remove any remaining TIM from the heatsink.

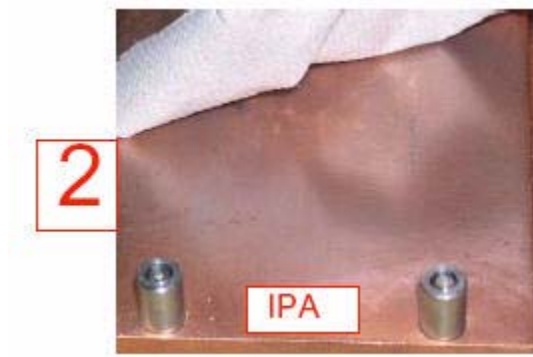

## Remove the Processor

1. Press the load lever down and away from the retention clasp to release the load plate from its locked position.

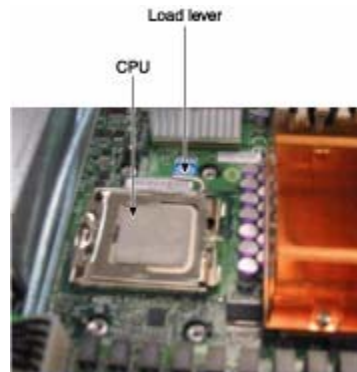

2. Gently lift the load lever to open the load plate.

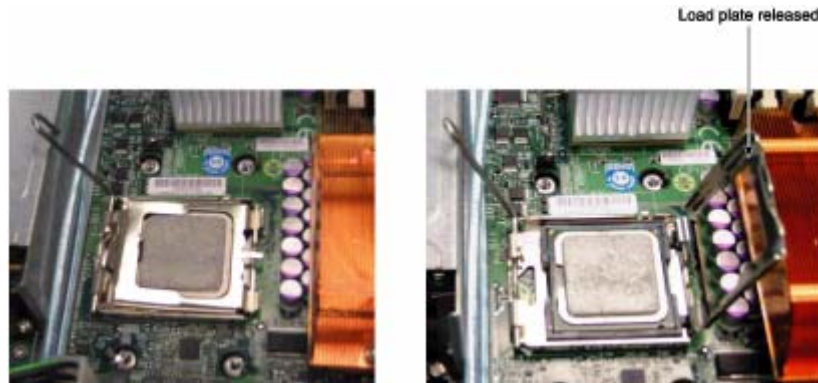

3. Use your thumb and your index finger to hold the CPU at opposite sides.
4. Carefully lift the CPU straight out of the socket.

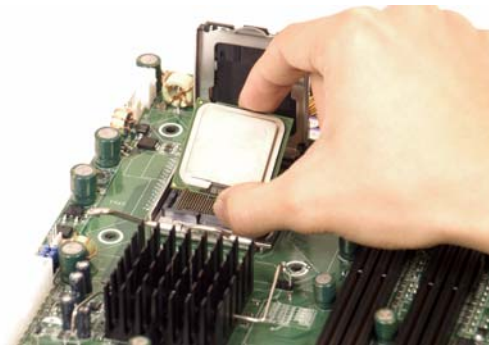

---

**Note:** If you are removing the processor so that you can return the node board to SGI, install a PnP cap in the socket.

---

## Install Memory



---

**Caution:** Exercise extreme care when installing or removing DIMM modules to prevent damage to the node board or DIMM module.

---

The node board provides eight 240-pin DIMM sockets that can support up to 32 GB of error correction code (ECC) fully buffered DIMM (FBDIMM) DDR2-667/533 SDRAM (for a total of 64 GB in the system). The memory scheme is interleaved; therefore, you must always add memory to two memory DIMM slots. Table 4-2 lists how to optimize your DIMM installation. Figure 4-11 shows the DIMM slot designations and bank locations on the node board.

## Memory Layout

The memory controller hub (MCH) supports FBDIMM in dual-channel mode. There are a maximum of eight DIMMs in each node board and DIMMs must be populated in groups of two (a DIMM pair).

There are four DIMM pairs as follows:

- DIMM pair 1: 1A and 2A
- DIMM pair 2: 3A and 4A
- DIMM pair 3: 1B and 2B
- DIMM pair 4: 3B and 4B

A minimum of one DIMM pair must be installed. Figure 4-6 illustrates the minimum population for such a configuration.

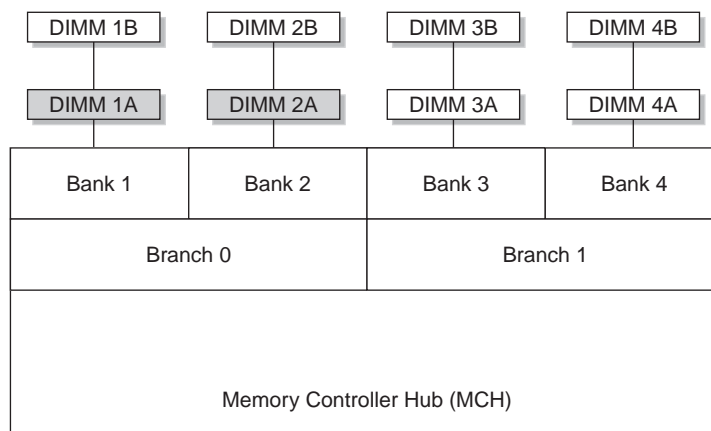

**Figure 4-6** Minimum Population for Dual-Channel Mode with Identical FBDIMMs

## Constraints for DIMM Pairs

The DIMM pairs (1A,2A), (3A,4A), (1B,2B), and (3B,4B) must be identical with respect to the following attributes:

- Size (1, 2, or 4 GB)
- Speed (533 or 667 MHz)
- Organization (x4- or x8-bit)

The DIMM pairs (1A,1B), (2A,2B), (3A,3B), and (4A,4B) do not need to be identical with respect to size, speed, and organization. The MCH will adjust to the lowest-speed DIMM.

## Performance Optimization

The primary rule for installing DIMMs to obtain maximum performance is the following:

**Balance the DIMM memory capacity across both memory branches.**

As illustrated in Figure 4-6, the MCH has memory Branch 0 and Branch 1. DIMMs 1A, 1B, 2A, and 2B are on Branch 0 and DIMMs 3A, 3B, 4A, and 4B are on Branch 1. If the total memory capacity of the DIMMs on each branch is not balanced, the memory performance will be degraded by approximately 25% and, in some cases, 40%.

Table 4-1 lists the recommended DIMM configurations to achieve maximum performance.

**Table 4-1** Recommended DIMM Configurations

DIMM Pair 1 Capacity	DIMM Pair 2 Capacity	DIMM Pair 3 Capacity	DIMM Pair 4 Capacity	Total Node Memory Size
2GB	2GB			4GB
4GB	4GB			8GB
2GB	2GB	2GB	2GB	8GB
4GB	2GB		2GB	8GB (mixed)
4GB	4GB	2GB	2GB	12GB (mixed)
8GB	8GB			16GB
4GB	4GB	4GB	4GB	16GB
8GB	4GB		4GB	16GB (mixed)
8GB	8GB	2GB	2GB	20GB (mixed)
8GB	8GB	4GB	4GB	24GB (mixed)
8GB	8GB	8GB	8GB	32GB

**Note:** DIMM configurations that are not described in Table 4-1 will run with degraded performance.

The following are examples of DIMM configurations that will yield degraded performance:



- Single DIMM pair
- Three DIMM pairs all having the same memory capacity

## Memory Sparring Mode

To select memory sparring mode, you must select sparring in the BIOS setup:

**Advanced --> Advanced Chipset Control**

Figure 4-7 illustrates the standard DIMM population for sparring mode.

Branch 0				Branch 1				Mirroring Possible	Sparring Possible
Bank 1		Bank 2		Bank 3		Bank 4			
DIMM 1A	DIMM 1B	DIMM 2A	DIMM 2B	DIMM 3A	DIMM 3B	DIMM 4A	DIMM 4B		
								yes	
									yes
								yes	yes

**Figure 4-7** Standard DIMM Population for Sparring or Mirroring

## Memory Mirroring Mode

The memory controller supports memory mirroring to prevent data loss in case of DIMM failure. The system maintains two copies of all the data in memory; therefore, a mirrored system uses only half of the installed DIMMs. If a DIMM fails, the system recovers the second copy of data from the mirrored DIMM in the opposite channel. If both the primary and the mirrored copy of the data becomes corrupt, the system will fail.

To select memory mirroring mode, you must select mirroring in the BIOS setup:

**Advanced --> Advanced Chipset Control**

Configure memory mirroring with the Memory Branch Mode BIOS setting (refer to “Memory Branch Mode” on page 113).

Figure 4-7 illustrates the standard DIMM population for mirroring mode.

The minimum number of DIMM supported in mirror mode is four. All four DIMMs must be identical in size, speed, and organization.

## Mirroring Mode Upgrade

To upgrade DIMM memory in mirroring mode, you must add four additional DIMMs. The additional four must be identical to initial four, except for speed. The MCH will adjust to the lowest-speed DIMM.

## Install DIMMs

Align the DIMM so that the notch along the bottom of the DIMM module (refer to Figure 4-8 and Figure 4-9) aligns with the notch in the DIMM slot. Insert DIMMs vertically and gently press down on the DIMM until it snaps into place.

---

**Note:** Refer to “Install or Remove the Air Shroud” on page 57 for a procedure on how to remove and install the air shrouds.

---

An “X” in the slot number (refer to Table 4-2) indicates that a DIMM slot is populated; “----” indicates a DIMM slot is not populated. Both fully buffered 533 MHz and 667 MHz DIMMs are supported, however, you need to use memory modules of the same speed and of the same type. Interleaved memory is supported only when pairs of DIMMs are installed in both Bank 1 and Bank 2.

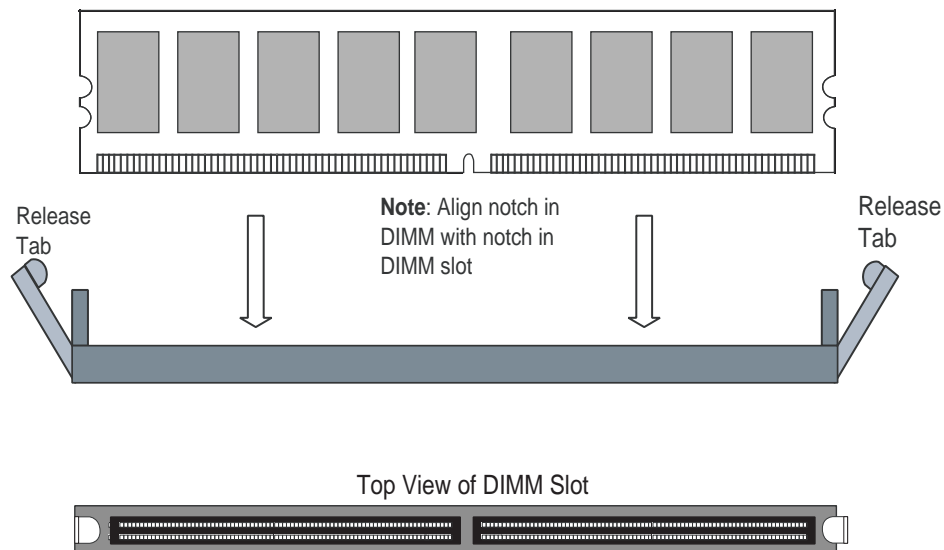
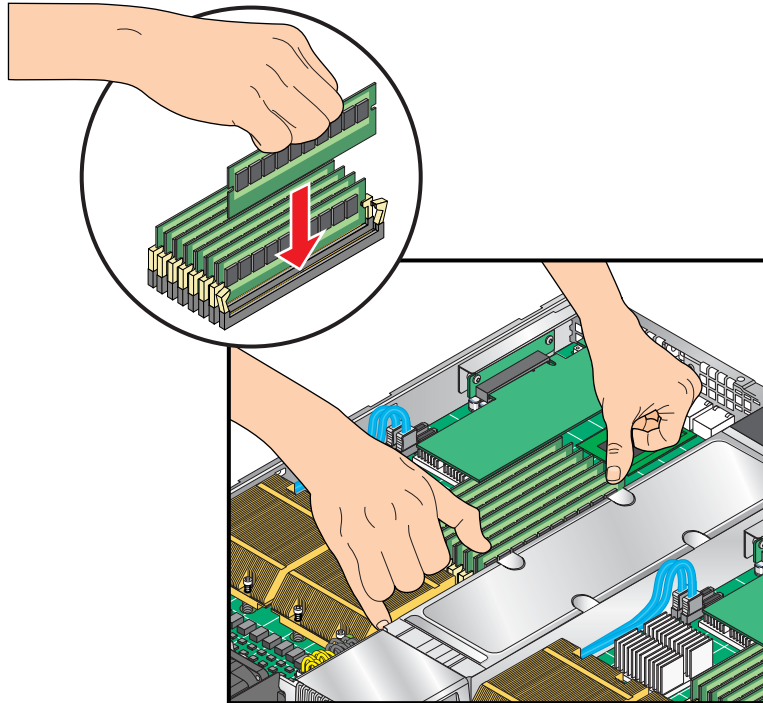

**Figure 4-8** Install DIMMs

Table 4-2 lists the order in which you should install DIMMs to optimize your memory configuration. Figure 4-11 shows the DIMM slot designations and bank locations on the node board.

**Table 4-2** DIMM Configurations

Number of DIMMs	Bank 1		Bank 2		Bank 3		Bank 4	
	Slot A	Slot B	Slot A	Slot B	Slot A	Slot B	Slot A	Slot B
2 DIMMs	X	---	X	---	---	---	---	---
4 DIMMs	X	---	X	---	X	---	X	---
6 DIMMs	X	X	X	X	X	---	X	---
8 DIMMs	X	X	X	X	X	X	X	X



**Figure 4-9** Replace DIMMs

## Install or Remove the Air Shroud

1. Position each air shrouds as shown in Figure 4-10.
2. Gently place the air shrouds over the node boards and just over the fan assemblies.
3. Slide the air shroud towards the rear of the chassis.
4. Position the front tab between the fan tray and 20-pin ATX power connector.
5. Press down on the front of the air shroud to secure it to the fan assemblies.

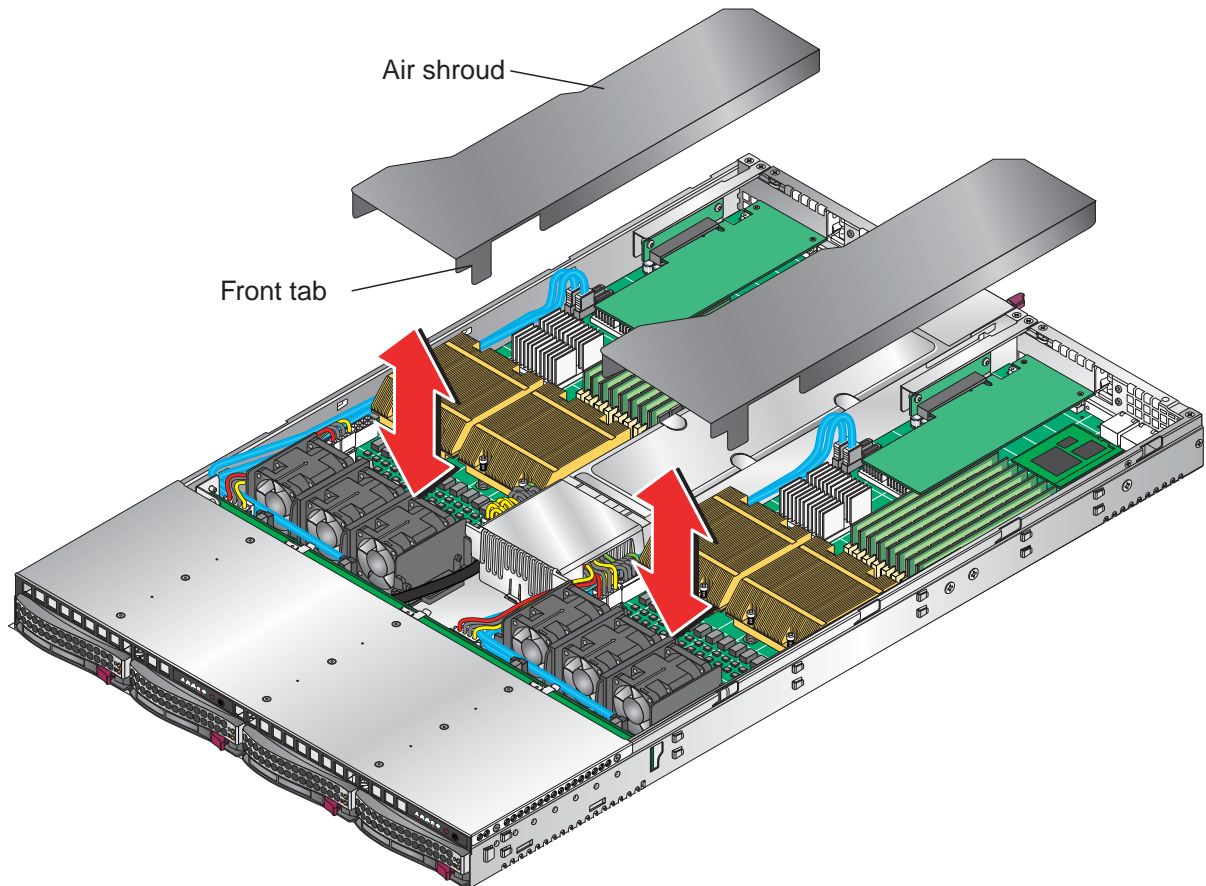

**Figure 4-10** Install Air Shrouds

## Node Board Component Locations

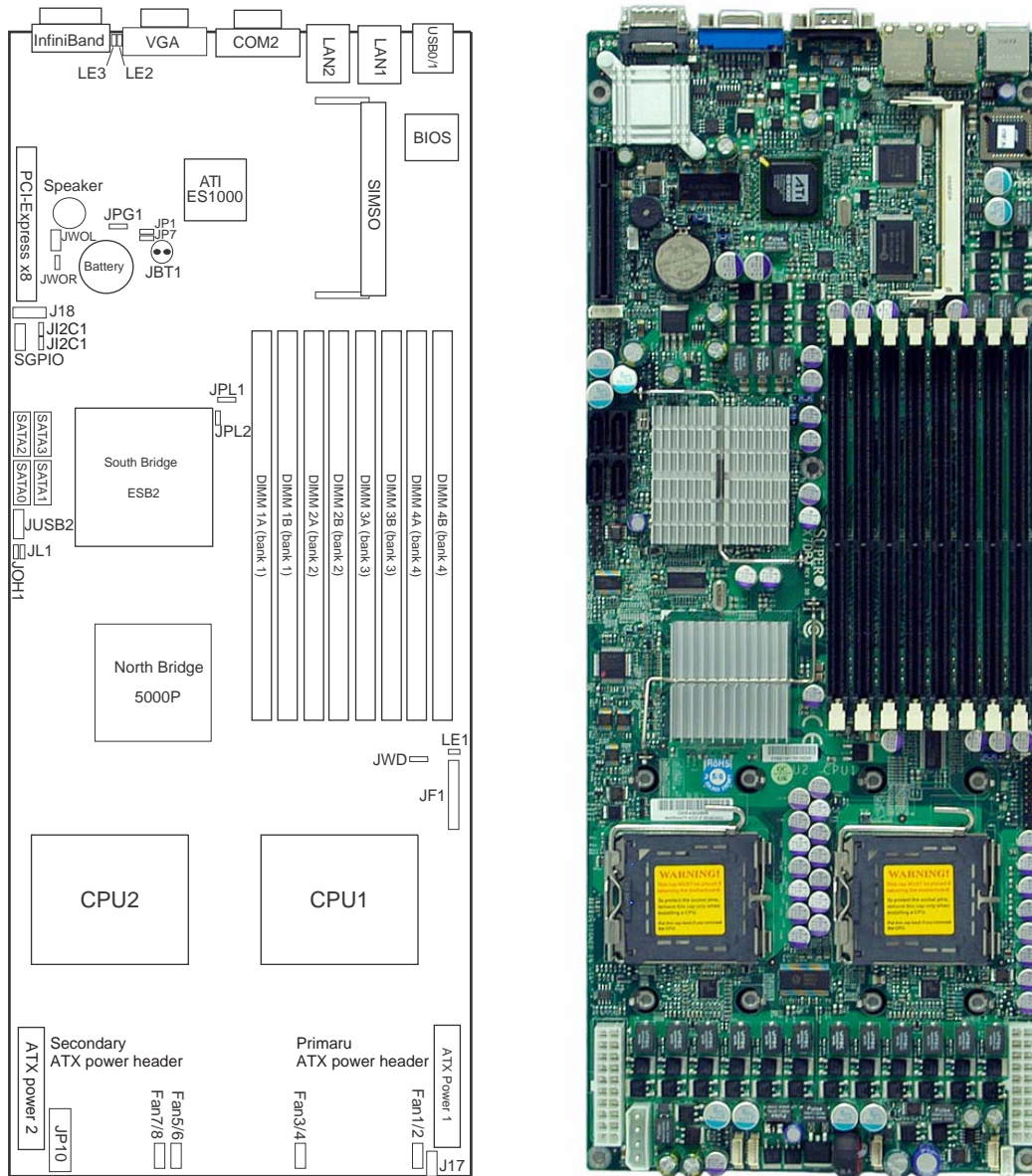

Figure 4-11 Node Board Component Locations

## Add PCIe Expansion Cards

The SGI Altix XE310 includes two preinstalled riser boards in the 1U rackmount chassis (refer to Figure 4-12). These riser cards support two low-profile PCIe x8 cards.

---

**Note:** Use only SGI approved PCIe x8 cards in the SGI Altix XE310 server.

---

### Install a PCIe Expansion Card

Perform the following steps to install a PCIe expansion card:

1. Remove the top cover in accordance with “Access the Inside of the Chassis” on page 22.
2. Remove the air shrouds in accordance with “Install or Remove the Air Shroud” on page 57.
3. Remove the PCIe slot EMI shield on the chassis by releasing the locking tab.
4. Insert the expansion PCIe card into the riser card and slide the bracket under the tab.
5. Secure the PCIe expansion card with the locking tab.
6. Install the air shrouds in accordance with “Install or Remove the Air Shroud” on page 57.
7. Install the top cover in accordance with “Access the Inside of the Chassis” on page 22.

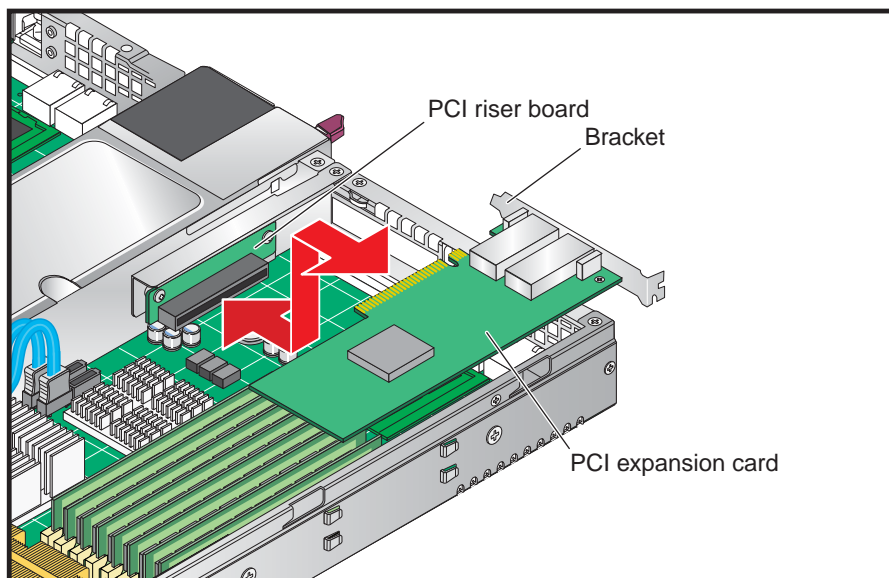

**Figure 4-12** Install a PCI Card



## Node Board Jumpers and Connectors

Refer to Figure 4-11 when using Table 4-3, Table 4-4 and Table 4-5.

**Table 4-3** Node Board Default Jumper Settings

Jumper	Description	Default Setting
JBT1	CMOS Clear	Refer to “CMOS Memory Clear (JBT1)” on page 75.
J <sup>2</sup> C1/J <sup>2</sup> C2	I <sup>2</sup> C to PCIe Slot	Open (Disabled)
JPG1	VGA Enable	Pins 1-2 (Enabled)
JPL1/ JPL2	LAN1/LAN2 Enable/Disable	Pins 1-2 (Enabled)
JWD	Watch Dog	Pins 1-2 (Reset)
IB, JIB, JWOL, JWOR, JP1, JP7, J18, SGPIO	N/A	No connection

**Table 4-4** Node Board Connector Descriptions

Connector	Description
ATX Power 1 <sup>a</sup>	20-Pin ATX PWR Connector (for Primary Board)
ATX Power 2	20-Pin ATX PWR Connector (for Secondary Board)
COM2	COM2 Serial Port Connector
FAN 1/2 - 7/8	Chassis and CPU Fan Connectors
InfiniBand	InfiniBand Connector
J17	System Management Power (I <sup>2</sup> C) Connector
J18	System Management Bus Connector
JF1	Front Control Panel Connector
JL1	Chassis Intrusion Connector (not used)
JOH1	Overheat LED Connector
JPI2C	System Management Power (I <sup>2</sup> C) Connector

**Table 4-4** Node Board Connector Descriptions (**continued**)

Connector	Description
JP10	4-pin Auxiliary Power Connector (for HDDs)
JWOL	Wake-on-LAN Connector
JWOR	Wake-on-Ring Connector
LAN1/2	Gigabit Ethernet Ports
SATA0 – SATA3	Intel SATA 0 – 3 Ports
SGPIO	Serial ATA General Purpose Input/Output Connector
SIMSO IPMI	SIMSO IPMI Socket
USB0/1	USB0/1 Ports

- a. The primary ATX power header is used to supply power to the node board 1 and the secondary ATX power header is used to supply power to the node board 2. Connect the power supply to only one of these on both boards (Node board 1 is the left node board and node board 2 is the right node board when viewed from front of server).

**Table 4-5** Node Board LED Descriptions

LED Indicator	Description
LE1	Onboard Power LED Indicator
LE2	InfiniBand Link LED (green)
LE3	InfiniBand Activity LED (yellow)

## Node Board Connector Pin Definitions

Use Table 4-6 to locate the page number for the node board connector or jumper.

**Table 4-6** Node Board Connector Pin Definitions

Connector Description	Page	Connector Name	Page
ATX Power Connector Pin Definitions	page 64	ATX Power 1/2	page 64
Auxiliary Power Connector Pin Definitions (JP10)	page 64	COM2	page 71
Chassis Intrusion Pin Definitions (JL1)	page 68	Fan1/2 - Fan7/8	page 68
Fan Header Pin Definitions (Fan1/2 - Fan7/8)	page 68	J17	page 72
HDD LED Pin Definitions (JF1)	page 66	J18	page 72
Ethernet Ports (LAN1/LAN2)	page 70	JF1	page 65 – page 67
NIC2 LED Pin Definitions (JF1)	page 66	JL1	page 68
NIC1 LED Pin Definitions	page 66	JP10	page 64
NMI Button Pin Definitions (JF1)	page 67	JWOL	page 70
Overheat/Fan Fail LED Pin Definitions (JF1)	page 65	JWOR	page 70
Power On LED Pin Definitions (JF1)	page 67	LAN1/LAN2	page 71
PW_ON Switch Pin Definitions (JF1)	page 65	SGPIO	page 70
Reset Switch Pin Definitions (JF1)	page 65		
Serial Port Pin Definitions (COM2)	page 71		
Serial General Purpose I/O Connector Pin Definitions (SGPIO)	page 71		
SMB Power Connector Pin Definitions (J17)	page 72		
SMB Header Pin Definitions (J18)	page 72		
Wake on LAN Connector Pin Definitions (JWOL)	page 70		
Wake on Ring Connector Pin Definitions	page 70		

## ATX Power Connector Pin Definitions

**Table 4-7** ATX Power Connector Pin Definitions

Notes	ATX Power 20-pin Connector Pin Definitions ATX Power 1/2			
	Pin#	Definition	Pin#	Definition
<p>The main ATX power supply connectors on the node board meet the SSI (Superset ATX) 24-pin specification.</p> <p><b>Note:</b> Only one of the two ATX power connectors from each node board should be connected to the power supply.</p>	11	PS On	1	Ground
	12	5VSB	2	Ground
	13	Ground	3	Ground
	14	Ground	4	Ground
	15	Ground	5	Ground
	16	NC2	6	NC1
	17	12V	7	12V
	18	12V	8	12V
	19	12V	9	12V
	20	12V	10	12V

## Auxiliary Power Connector Pin Definitions (JP10)

**Table 4-8** Auxiliary Power Connector Pin Definitions (JP10)

Notes	Auxiliary Power Pin Definitions JP10	
	Pin#	Definition
<p>A 4-pin 12V auxiliary power connector is included to provide power to hard drive disks.</p>	1	+12V
	2	Ground
	3	Ground
	4	+5V

## PW\_ON Switch Pin Definitions (JF1)

**Table 4-9** PW\_ON Switch Pin Definitions (JF1)

Notes	PW_ON Button Pin Definitions JF1	
	Pin#	Definition
The PW_ON connector is on pins 1 and 2 of JF1 (refer to Figure 4-16 on page 78). This header should be connected to the chassis power button.	1	PW_ON
	2	Ground

## Reset Switch Pin Definitions (JF1)

**Table 4-10** Reset Switch Pin Definitions (JF1)

Notes	Reset Button Pin Definitions JF1	
	Pin#	Definition
The reset connector is located on pins 3 and 4 of JF1 (refer to Figure 4-16 on page 78) and attaches to the reset switch on the computer chassis.	3	Reset
	4	Ground

## Overheat/Fan Pin Definitions (JF1)

**Table 4-11** Overheat/Fan Fail LED Pin Definitions (JF1)

Notes	OH/Fan Fail LED Pin Definitions JF1	
	Pin#	Definition
The overheat (OH) fan fail LED connection is on pins 7 and 8 of JF1 (refer to Figure 4-16 on page 78), which provides advanced warning of chassis overheating.	7	Vcc
	8	Ground

## NIC2 LED Pin Definitions (JF1)

**Table 4-12** NIC2 LED Pin Definitions (JF1)

Notes	NIC2 LED Pin Definitions JF1	
	Pin#	Definition
The NIC2 LED connection (LAN2) is on pins 9 and 10 of JF1 (refer to Figure 4-16 on page 78) and displays network activity on LAN 2.	9	Vcc
	10	Ground

## NIC1 LED Pin Definitions (JF1)

**Table 4-13** NIC1 LED Pin Definitions

Notes	NIC2 LED Pin Definitions JF1	
	Pin#	Definition
The NIC1 LED connection is on pins 11 and 12 of JF1 (refer to Figure 4-16 on page 78) and displays network activity on LAN 1.	11	Vcc
	12	Ground

## HDD LED Pin Definitions (JF1)

**Table 4-14** HDD LED Pin Definitions (JF1)

Notes	HDD LED Pin Definitions JF1	
	Pin#	Definition
The HDD LED connection is located on pins 13 and 14 of JF1 (refer to Figure 4-16 on page 78). Attach the hard drive LED cable here to display disk activity (for any disk drives in the system, including SAS, serial ATA and IDE disk drives).	13	Vcc
	14	HD Active

## Power On LED Pin Definitions (JF1)

**Table 4-15** Power On LED Pin Definitions (JF1)

Notes	Power On LED Pin Definitions JF1	
	Pin#	Definition
The Power On LED connector is located on pins 15 and 16 of JF1. Use this connection is used to indicate that power is supplied to the system.	15	5V Standby
	16	Control

## NMI Switch Pin Definitions (JF1)

**Table 4-16** NMI Button Pin Definitions (JF1)

Notes	Power On LED Pin Definitions JF1	
	Pin#	Definition
The non-maskable interrupt button header is located on pins 19 and 20 of JF1.	19	Vcc
	20	Ground

## Fan Connector Pin Definitions (Fan1/2 - Fan7/8)

**Table 4-17** Fan Header Pin Definitions (Fan1/2 - Fan7/8)

Notes	Fan Header Pin Definitions Fan1/2 - Fan7/8			
	Pin#	Definition	Pin#	Definition
<p>The node board has four 6-pin proprietary fan headers. Each fan header supports two 3-pin fans.</p> <p><b>Note:</b> The onboard fan speed is controlled by the CPU die temperature.</p>	1	PWR (DC Speed CTRL)	4	Ground
	2	Tachometer for Fan 1/3/5	5	Tachometer for Fan 2/4/6
	3	Ground	6	PWR (DC Speed CTRL)

## Chassis Intrusion Connector Pin Definitions (JL1)

**Table 4-18** Chassis Intrusion Pin Definitions (JL1)

Notes	Chassis Intrusion Pin Definitions JL1	
	Pin#	Definition
<p>The Chassis Intrusion connector is designated JL1 (refer to Figure 4-15 on page 77). <b>Note: The feature is not supported on the SGI Altix XE310 server.</b></p>	1	Intrusion Input
	2	Ground



## USB Connector Pin Definitions (USB0/USB1)

**Table 4-19** Universal Serial Bus (USB) Pin Definitions

Notes	USB Ports USB0/1			
	Pin#		Definition	
There are two Universal Serial Bus ports located on the I/O panel and two additional USB headers located on the node board. The headers, labeled USB2 and USB3, can be used to provide front side USB access (cables not included).	1		+5V	
	2		PO-	
	3		PO+	
	4		Ground	
	5		N/A	
	USB Headers USB1, USB2			
	USB3/5		USB2/4	
	Pin#	Definition	Pin#	Definition
	1	+5V	1	+5V
	2	PO-	2	PO-
	3	PO+	3	PO+
	4	Ground	4	Ground
	5	Key	5	NC

## Ethernet Port (LAN1/LAN2)

**Table 4-20** Ethernet Ports (LAN1/LAN2)

Notes	Ethernet Ports LAN1/LAN2
Two gigabit Ethernet ports (designated LAN1 and LAN2) are located on the I/O panel. These ports accept RJ45 type cables.	

## Wake on LAN Connector Pin Definitions (JWOL)

**Table 4-21** Wake on LAN Connector Pin Definitions (JWOL)

Notes	Wake-On-LAN Pin Definitions JWOL	
	Pin#	Definition
The Wake-On-LAN (JWOL) connector (refer to Figure 4-14) enables the wake-on-LAN feature. You must enable the LAN Wake-Up setting in BIOS and also have a LAN card with a wake-on-LAN connector and cable installed to use this feature.	1	+5V Standby
	2	Ground
	3	Wake-up

## Wake on Ring Connector Pin Definitions (JWOR)

**Table 4-22** Wake on Ring Connector Pin Definitions

Notes	Wake-On-Ring Pin Definitions JWOR	
	Pin#	Definition
The Wake-On-Ring connector (JWOR) connector (refer to Figure 4-14) enables the system to receive and be “awakened” by an incoming call when in the suspend state. You must also have the WOR card and cable installed to use this feature.	1	Ground (Black)
	2	Wake-up

## Serial Port Pin Definitions (COM2)

**Table 4-23** Serial Port Pin Definitions (COM2)

Notes	Serial Port Pin Definitions COM2			
	Pin#	Definition	Pin#	Definition
One serial port is included on the node board: COM2 is a port located beside the VGA port.	1	DCD	6	DSR
	2	RXD	7	RTS
	3	TXD	8	CTS
	4	DTR	9	RI
	5	Ground	10	NC

## Serial General Purpose I/O Connector Pin Definitions (SGPIO)

**Table 4-24** Serial General Purpose I/O Connector Pin Definitions (SGPIO)

Notes	SGPIO Headers Pin Definitions SGPIO			
	Pin#	Definition	Pin#	Definition
The Serial General Purpose Input/Output (SGPIO) connector (refer to Figure 4-14) is used to communicate with the system monitoring circuitry and monitor SATA activity.	1	NC	2	NC
	3	Ground	4	DATA Out
	5	Load	6	Ground
	7	Clock	8	NC

## System Management Bus Power Connector Pin Definitions (J17)

**Table 4-25** SMB Power Connector Pin Definitions (J17)

Notes	SMB Power (I <sup>2</sup> C) Pin Definitions J17	
	Pin#	Definition
The system management bus (SMB) power connector (J17) is used to support the I2C bus.	1	Clock
	2	Data
	3	Power Fail
	4	Ground
	5	+3.3V

## System Management Bus Connector Pin Definitions (J18)

**Table 4-26** SMB Header Pin Definitions (J18)

Notes	SMB Header Pin Definitions J18	
	Pin#	Definition
A SMB bus connector (J18) monitors the status of the system's power supply, fan speed, and temperature (refer to Figure 4-14 on page 75).	1	Data
	2	Ground
	3	Clock
	4	NC

## Node Board Jumper Settings

**Table 4-27** Node Board Jumper Descriptions

Connector Description	Page
CMOS Memory Clear (JBT1)	page 75
I2C to PCIe Slot Jumper Settings (JPI2C1/JPI2C2)	page 76
LAN1/LAN2 Jumper Settings (JPL1/JPL2)	page 77
VGA Jumper Settings (JPG1)	page 76
Watch Dog Timer Jumper Settings (JWD)	page 78

Jumper Name	Page
JBT1	page 75
JPG1	page 76
JPI2C1/JPI2C2	page 76
JPL1/JPL2	page 77
JWD	page 78

## Explanation of Jumper Settings

To modify the operation of the node board, jumpers (refer to Figure 4-13) can be used to choose between optional settings. Jumpers create shorts between two pins to change specific functions or features on the node board. Pin 1 is identified with a square solder pad on the printed circuit board. Refer to Figure 4-11 on page 58 for jumper locations.

**Note:** On a two-pin jumper, “Closed” means the jumper is on both pins and “Open” means the jumper is either on only one pin or completely removed.

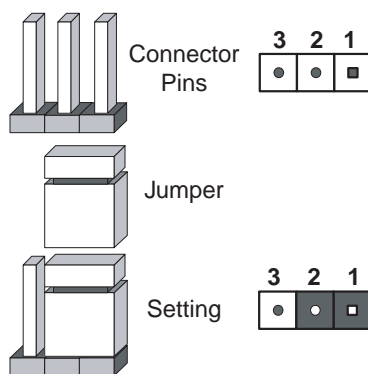

**Figure 4-13** Explanation of Jumper Pins

## CMOS Memory Clear (JBT1)

Jumper pad JBT1 (refer to Figure 4-14) is used to clear CMOS memory (which also clears passwords). Instead of pins, this jumper consists of contact pads to prevent you from accidentally clearing the contents of CMOS memory. To clear CMOS memory:

1. Power down the system and unplug the power cord(s).



**Caution:** Do not use the PW\_ON connector to clear CMOS memory. Using the PW\_ON connector to clear CMOS memory may damage the equipment.

2. Short the JBT1 pads with a metal object such as a small screwdriver.
3. Remove the screwdriver (or shorting device).
4. Reconnect the power cord(s) and power on the system.

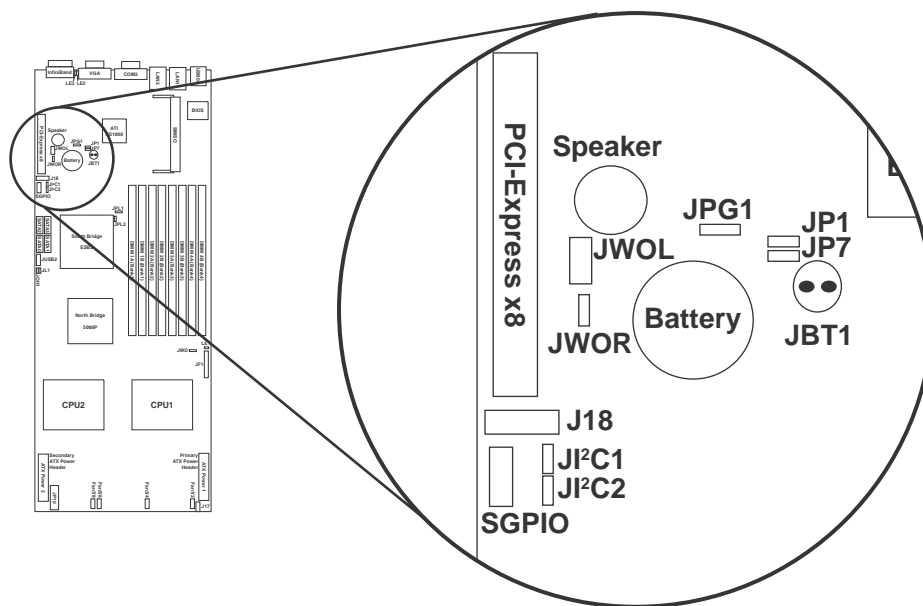

**Figure 4-14** CMOS Memory Jumper Location (JBT1)

## VGA Jumper Settings (JPG1)

**Table 4-28** VGA Jumper Settings (JPG1)

Notes	VGA Enable/Disable Jumper Settings JPG1	
	Jumper	Definition
Jumper JPG1 (refer to Figure 4-14) enables or disables the VGA port. The default position is pins 1 and 2 jumpered, which enables VGA port.	1-2	Enabled
	2-3	Disabled

## I<sup>2</sup>C to PCIe Slot Jumper Settings (JPI2C1/JPI2C2)

**Table 4-29** I<sup>2</sup>C to PCIe Slot Jumper Settings

Notes	I <sup>2</sup> C to PCIe Slot Jumper Settings JPI2C1/JPI2C2	
	Jumper	Definition
Jumpers JI2C1 and JI2C2 (refer to Figure 4-14) enable or disable I <sup>2</sup> C bus communication with the PCIe slot. Always set both jumpers to the same setting. If enabled, both jumpers must be enabled. If disabled, both jumpers must be disabled.	Closed	Enabled
	Open	Disabled



## LAN1/LAN2 Jumper Settings (JPL1/JPL2)

**Table 4-30** LAN1/LAN2 Jumper Settings (JPL1/JPL2)

Notes	LAN1/LAN2 Enable/Disable Jumper Settings JPL1/JPL2	
	Jumper	Definition
Jumper JPL1 (refer to Figure 4-15) enables or disables the LAN1 port and JPL2 to enable or disable the LAN2 port on the node board. The default setting is enabled.	1-2	Enabled
	2-3	Disabled

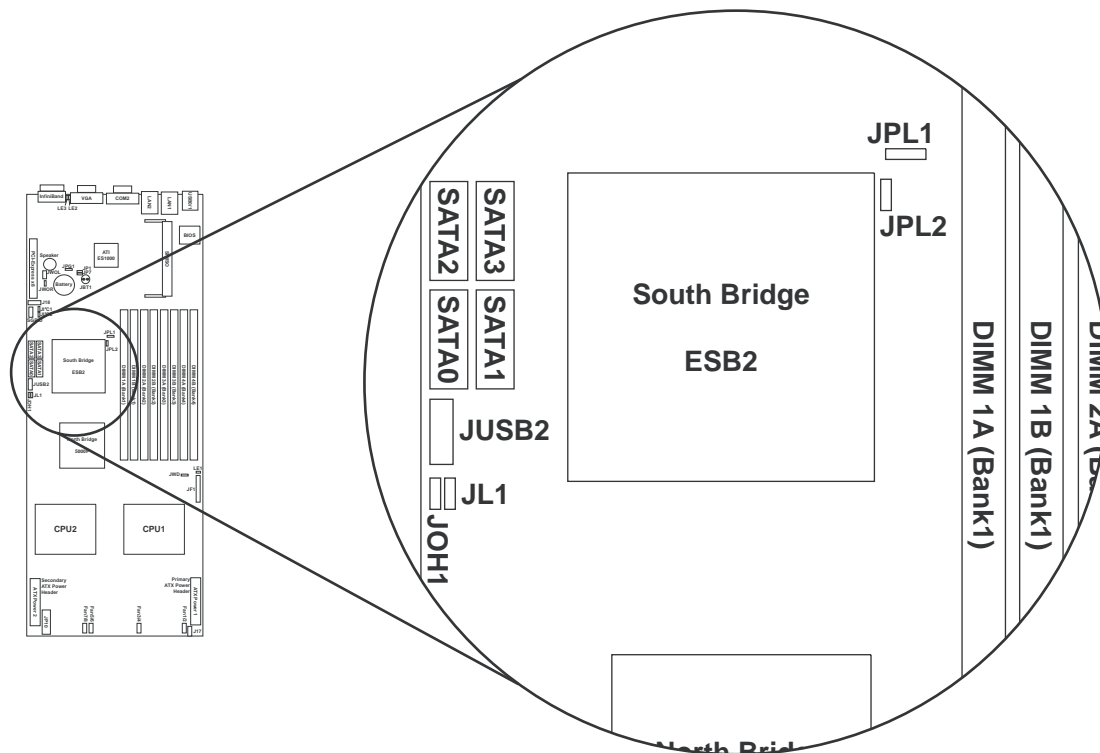

**Figure 4-15** LAN 1 and LAN 2 Jumper Locations (JPL1/JPL2)

## Watch Dog Timer Jumper Settings (JWD)

Users must write their own application software to disable the watch dog timer when it is enabled.

**Table 4-31** Watch Dog Timer Jumper Settings (JWD)

Notes	Watch Dog Jumper Settings JWD	
	Jumper	Definition
Jumper JWD (refer to Figure 4-16) enables or disables the watch dog timer, a system monitor that takes action when a software application freezes or hangs. Jumping pins 1-2 causes the watch dog timer to reboot the system if a program freezes. Jumping pins 2-3 generates a non-maskable interrupt for the program that has frozen. The watch dog timer must also be enabled in BIOS.	Pins 1-2	Reset
	Pins 2-3	NMI
	Open	Disabled

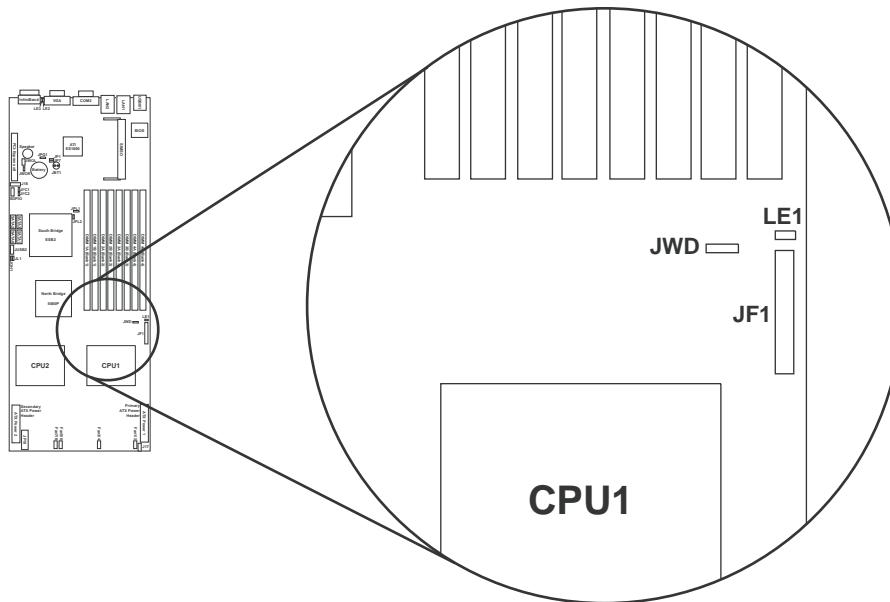

**Figure 4-16** Watch Dog Timer Jumper Location (JWD)

## Node Board LED Descriptions

### LAN1 and LAN2 (Ethernet Ports)

**Table 4-32** LAN1 and LAN 2 LED Descriptions

Notes	LAN LED Speed Indicators LAN1/LAN2	
	LED Color	Description
The Ethernet ports (located beside the serial COM2 port) have two LEDs. On each Gigabit LAN port, one LED indicates activity when blinking while the other LED may be green, amber, or off to indicate the speed of the connection.	Off	10 MHz
	Green	100 MHz
	Amber	1 GHz

### Power LED (LE1)

**Table 4-33** Power LED Description (LE1)

Notes	Power LED LE1	
	LED Color	Description
The Onboard Power LED (LE1) is located near connector JF1 (refer to Figure 4-16 on page 78). When the LED is green and flashing, power is connected.	Green (solid)	Power is on and system is on
	Green (flashing)	Power in standby, power cable connected, or system is off
	Off	Power off or power cable not connected

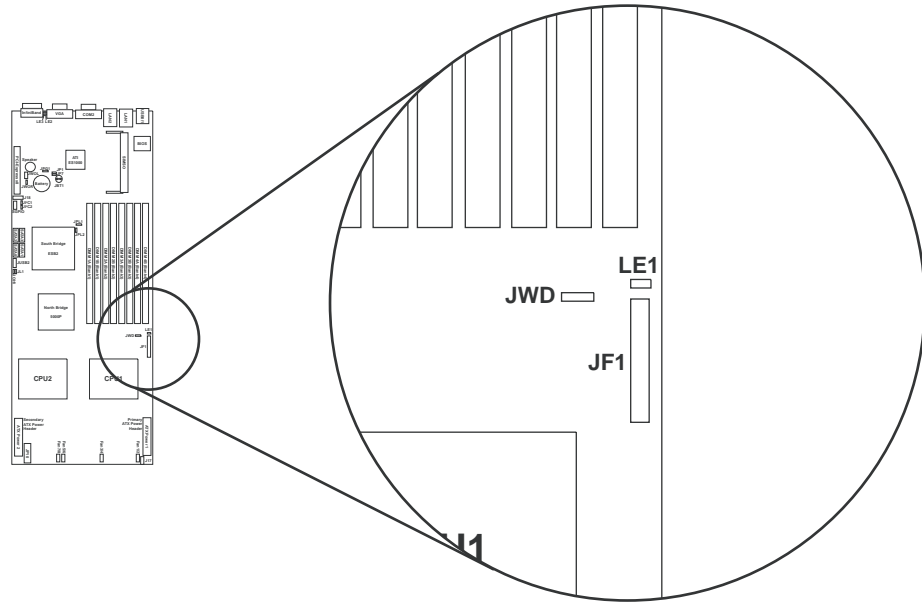
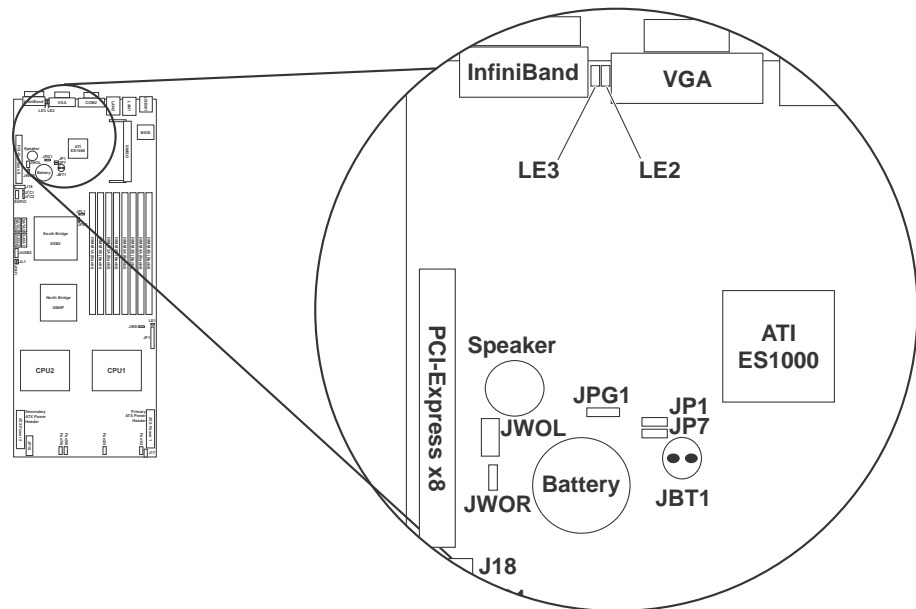

**Figure 4-17** InfiniBand Link LED Location (LE1)

## InfiniBand Link/Activity LEDs (LE2/LE3)

**Table 4-34** InfiniBand Link/Activity LED Descriptions (LE2/LE3)

Notes	InfiniBand Link/Activity LEDs LE2/LE3	
	LED Color	Description
Two InfiniBand LED Indicators (LE2/LE3) are located near the InfiniBand connector (refer to Figure 4-18). The green LED (LE2) is the InfiniBand Link LED while the yellow LED (LE3) indicates activity.	LE2 Green (solid)	InfiniBand connected
	LE2 (Off)	No connection
	LE3 Yellow (solid)	InfiniBand active
	LE3 Yellow (dim)	InfiniBand connected but idle
	Off	No connection



**Figure 4-18** InfiniBand Link LED Location (LE2)



## Advanced Chassis Setup

This chapter covers the steps required to install components and perform maintenance on the SGI Altix XE310 chassis (refer to Figure 5-1 and Figure 5-2).

### ESD Precautions

Electrostatic Discharge (ESD) can damage electronic components. To prevent damage to any printed circuit boards (PCBs), it is important to handle them very carefully. The following measures are generally sufficient to protect your equipment from ESD discharge.

- Use a grounded wrist strap designed to prevent static discharge.
- Touch a grounded metal object before removing any board from its antistatic bag.
- Handle a board by its edges only; do not touch its components, peripheral chips, memory modules, or gold contacts.
- When handling chips or modules, avoid touching their pins.
- Put the node board, add-on cards, and peripherals back into their antistatic bags when not in use.
- For grounding purposes, make sure your computer chassis provides excellent conductivity between the power supply, the case, the mounting fasteners, and the node board.
- The node board is shipped in antistatic packaging to avoid static damage. When unpacking the board, make sure the person handling it is static protected.

## Chassis Components

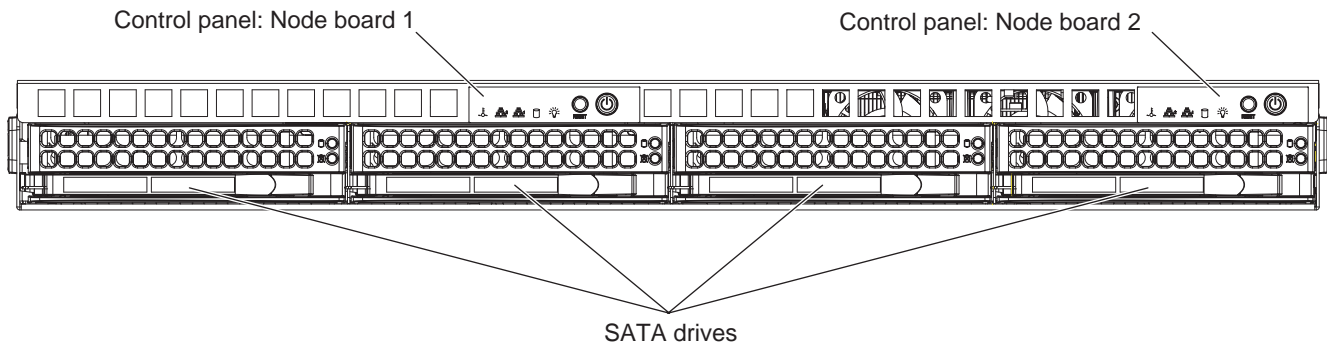

**Figure 5-1** Chassis Front View

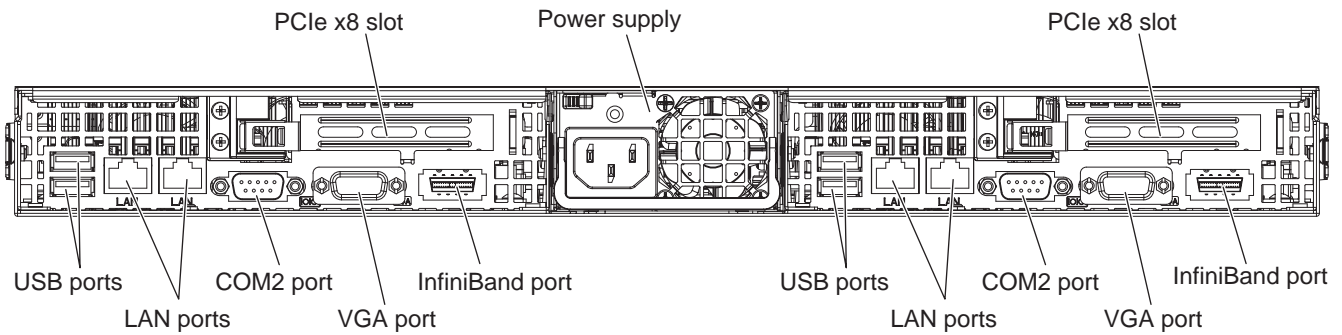

**Figure 5-2** Chassis Rear View



## Control Panel

Each control panel on the front of the chassis must be connected to the JF1 connector on its associated node board to provide you with system control buttons and status indicators. When viewed from the front of the chassis, the node board on the left is referred to as node board 1 and the node board on the right is node board 2.

These wires have been bundled together in a ribbon cable to simplify the connection. Refer to Table 4-6 on page 63. Connect the cable from JF1 (refer to Figure 5-3) on the node board to the control panel printed circuit board (PCB). Make sure the red wire plugs into pin 1 on both connectors. Pull all excess cabling out of the airflow path. The LEDs inform you of the node board status.

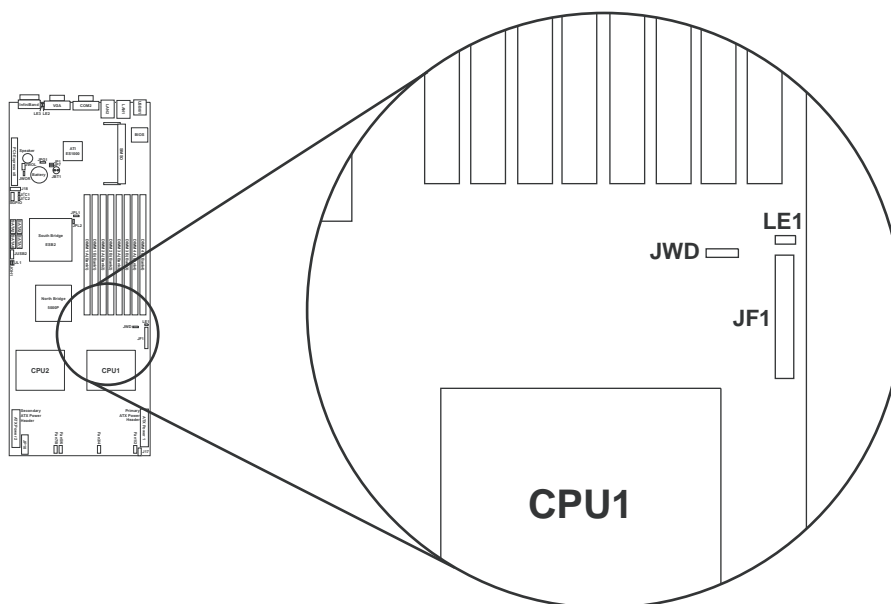

**Figure 5-3** JF1 Connector Location

## Part Numbers and Marketing Codes

Table 5-1 lists the marketing codes and part numbers for the SGI Altix XE310 server.

**Table 5-1** Part Numbers and Marketing Codes

Description	SGI Part number/Marketing Code
1U base chassis (GigE on-board) with two compute nodes	LSX-BASE-310-GE
1U base chassis (IB and GigE onboard) with two compute nodes	LSX-BASE-310-IB
146GB 15K RPM SAS system disk drive	LSX-SASDRV-146G-Z
300GB 15K RPM SAS system disk drive	LSX-SASDRV-300G-Z
73GB 15K RPM SAS system disk drive	LSX-SASDRV-73G-Z
250GB 7200 RPM SATA system disk drive	LSX-SATADRV-250G-Z
500GB 7200 RPM SATA system disk drive	LSX-SATADRV-500G-Z
750GB 7200 RPM SATA system disk drive	LSX-SATADRV-750G-Z
Disk drive trays	9470878
PCA, node board (Green creek chipset), with InfiniBand	030-2230-001
PCA, SAS Backplane	030-2232-001
PCA, riser card, 1U	030-2233-001
PCA, AOC-SIMSO, BMC IPMI2.0	030-2234-001
Power supply, 980+ watts	060-0262-001
Fan, 1U, 4mm x 40mm x 56mm, 6-pin with 5cm cable	9310221
Power cable, 4-pin	018-1355-001
SATA cables, set of 4	018-1356-001
Ribbon cable, round 16-pin to 16-pin	018-1354-001
Rackmount chassis	013-5425-001
System rail mounting kit	026-1598-001
Heat Sink 1U passive	7262257

**Table 5-1** Part Numbers and Marketing Codes **(continued)**

Description	SGI Part number/Marketing Code
Front panel LED board	9071049
Power Distribution Board	030-2229-001

## System Fans

Each node board has its own set of three 4-cm high-performance fans (for a total of six in the chassis) to provide the cooling for the SGI Altix XE310. The fan speed can be controlled by a setting in BIOS. Refer to Chapter 6, “BIOS Settings” for more information.

## System Fan Failure

If a fan fails, the remaining fans ramp up to full speed and the overheat/fan fail LED on the control panel blinks on and off. Replace any failed fan at your earliest convenience with a replacement fan from SGI (the system can continue to run with a failed fan). Remove the top chassis cover while the system is still running to determine which of the fans has failed. Then, power down the system and remove the power cord before replacing a fan.

## Disk Drive Replacement

---

**Note:** Drives can be removed during operation (hot swapped) only if you are running an operating system that supports RAID.

---



---

**Caution:** Use caution when working with the SATA/SAS backplane. Do not touch the backplane with any metal objects, and make sure that ribbon cables do not touch the backplane. Also, regardless of how many drives are installed, all four drive carriers must remain in the chassis to maintain proper airflow. Failure to follow these precautions can damage the equipment.

---

## Disk Drive Installation

### Mounting a Drive in a Drive Carrier

The drives are mounted in drive carriers (refer to Figure 5-4) to simplify their installation and removal from the chassis. These carriers also help promote proper airflow for the system. For this reason, even empty carriers without drives installed must remain in the chassis. To add a new drive, install it into the carrier with the printed circuit board side facing down so that the mounting holes align with those in the carrier. Secure the drive to the carrier with four screws, as shown in Figure 5-4.

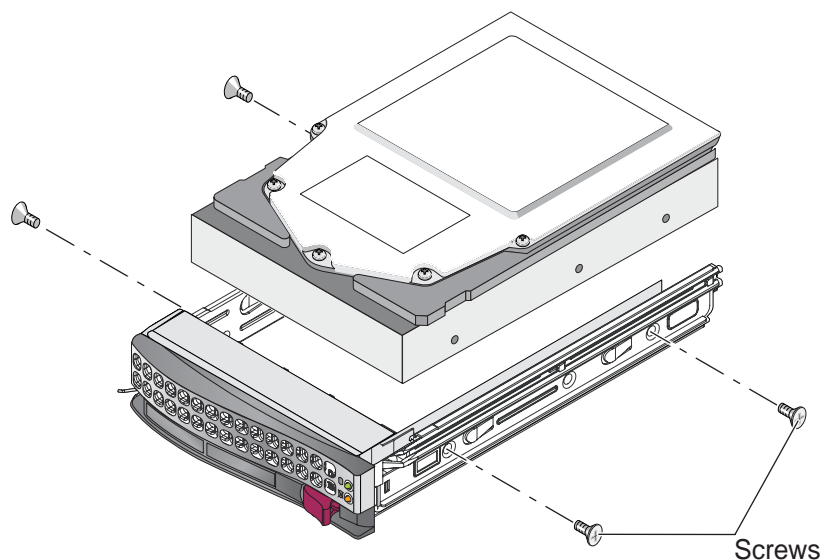

**Figure 5-4** Disk Drive Carrier

## Drive Replacement

The drive carriers are all easily accessible at the front of the chassis. These are (with RAID enabled) hot-swap drives. To remove a carrier, push the release button located beside the drive LEDs. Then, swing the handle fully out and use it to pull the unit straight out (refer to Figure 5-5).

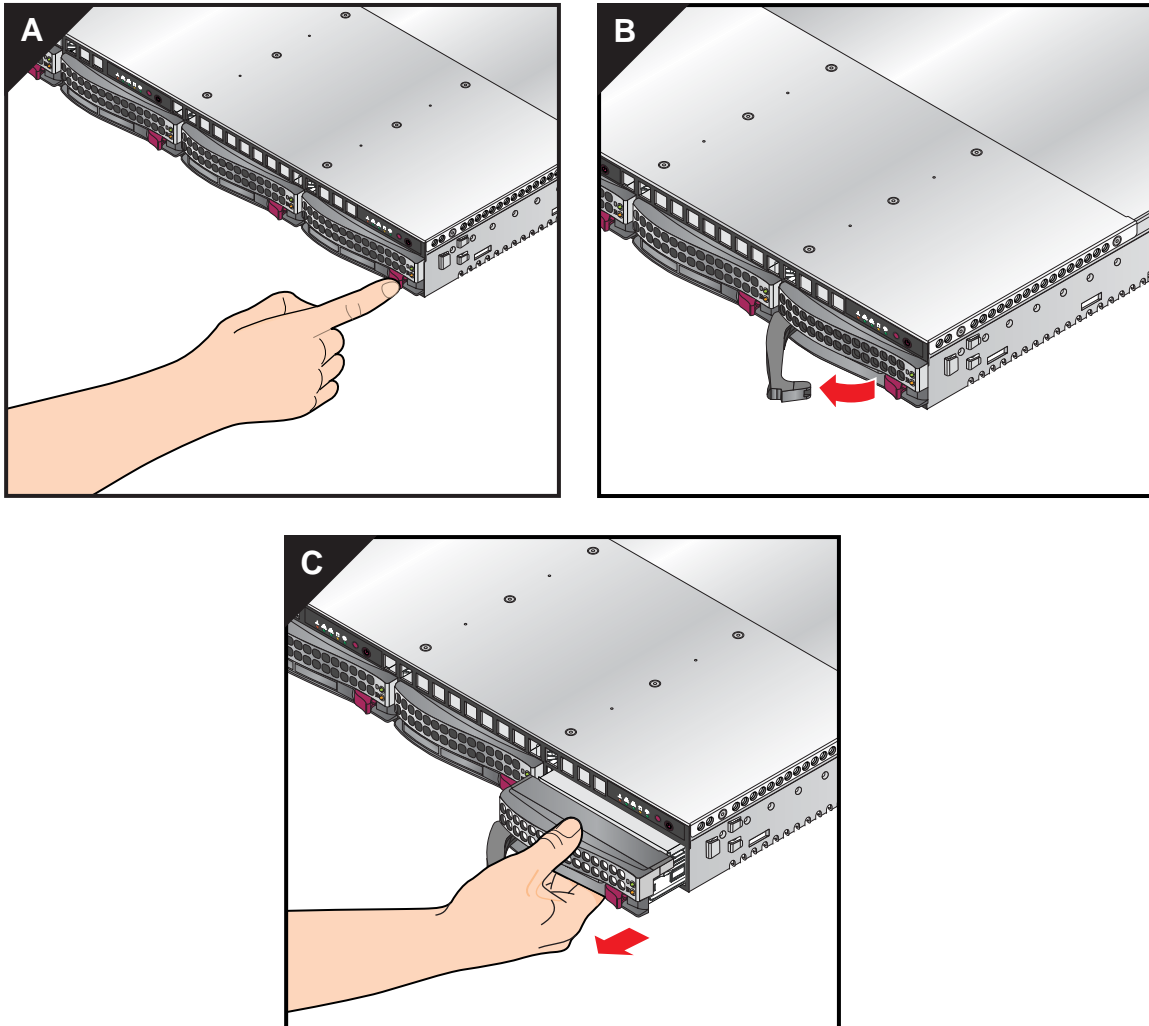

**Figure 5-5** Drive Removal

## Power Supply

The SGI Altix XE310 has a single 980 watt power supply. This power supply has the capability of operating at 100 - 240 input volts. Depress both main power buttons on the front of the chassis and then unplug the AC power cord to completely remove power from the system before removing the power supply.

## Power Supply Failure

If the power supply unit fails, the system shuts down and you must replace the power supply. Replacement power supplies can be ordered directly from SGI customer service.

## Power Supply Replacement

To replace a power supply (refer to Figure 5-6):

1. Unplug the power cord from the system.
2. Use the handle to grasp the power supply.
3. Move the lever to the right to unseat the power supply connector from the chassis.
4. Slide the power supply straight out of the chassis.

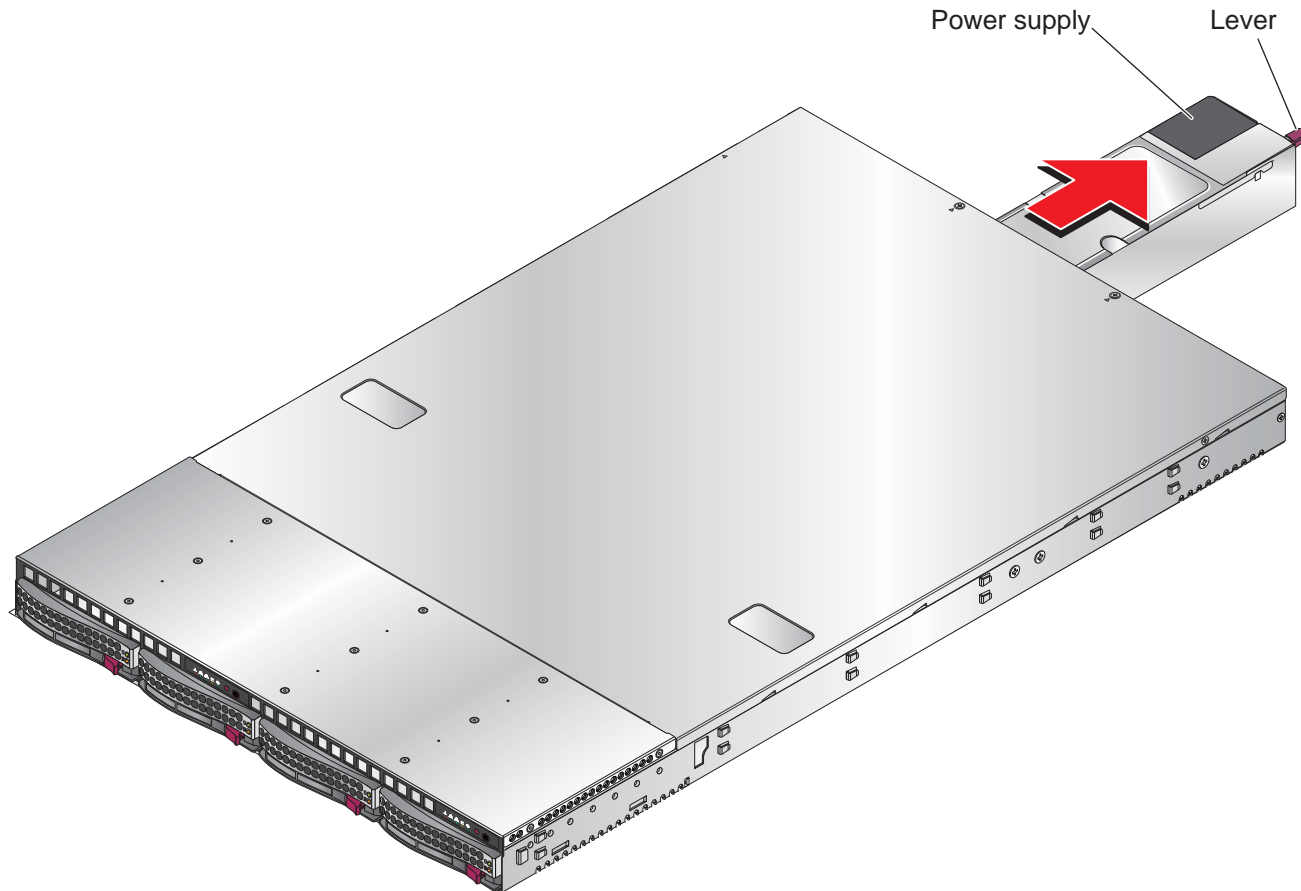

**Figure 5-6** Power Supply Replacement





---

## BIOS Settings

This chapter lists the BIOS default settings and describes the setup utility for the node board. The BIOS is stored in a flash chip and can be easily upgraded. For the upgrade procedure, see Appendix G, “Upgrading BIOS”.

---

**Note:** Due to periodic changes to the BIOS, some settings may have been added or deleted and might not yet be recorded in this manual.

---

### Default Settings

---

**Note:** Some of the settings in Table 6-1 are reported by the system and stored in flash memory as a BIOS setting and cannot be changed. Examples are Extended Memory, CPU Speed, Fan RPM, etc.

---

**Table 6-1** BIOS Default Settings

Menu Item	Setting	Page
<b>Main</b>		
System Time	[08:36:58]	104
System Date	[01/17/2007]	104
BIOS Date	12/28/06	104
> SATA Port 0	[None]	
> SATA Port 1	[None]	
> SATA Port 2	[None]	
> SATA Port 3	[None]	

---

**Table 6-1** BIOS Default Settings **(continued)**

<b>Menu Item</b>	<b>Setting</b>	<b>Page</b>
Serial ATA	[Enabled]	105
Native Mode Operation	[Serial ATA]	106
SATA Controller Mode Option	[Enhanced]	106
SATA RAID	[Disabled]	107
SATA AHCI	[Enabled]	107
System Memory	634 KB	107
Extended Memory	2047 MB ( <i>varies</i> )	107
<b>MAIN / SATA Port</b>		
Type	[Auto]	105
Multi-Sector Transfers	[16 Sectors]	106
LBA Mode Control	[Enabled]	106
32 Bit I/O	[Disabled]	106
Transfer Mode	[FPIO 4 / DMA 2]	106
Ultra DMA Mode	[Mode 5]	106
<b>Advanced / Boot Features</b>		
QuickBoot Mode	[Enabled]	108
QuietBoot Mode	[Enabled]	108
POST Errors	[Disabled]	109
ACPI Mode	[Yes]	109
Power Button Behavior	[Instant-Off]	109
Resume On Modem Ring	[Off]	109
Power Loss Control	[Last State]	109
Watch Dog	[Disabled]	109
Summary screen	[Enabled]	109

**Table 6-1** BIOS Default Settings **(continued)**

<b>Menu Item</b>	<b>Setting</b>	<b>Page</b>
<b>Advanced / Memory Cache</b>		
Cache System BIOS area	[Write Protect]	110
Cache Base 0-512k	[Write Back]	110
Cache Base 512k-640k	[Write Back]	110
Cache Extended Memory Area	[Write Back]	110
<b>Advanced / PCI Configuration</b>		
Onboard G-LAN1 OPROM Configure	[Enabled]	111
Onboard G-LAN2 OPROM Configure	[Enabled]	111
Default Primary Video Adapter	[Onboard]	111
Emulated IRQ Solution	[Disabled]	111
PCIe I/O Performance	[Payload 256B]	111
PCI Parity Error Forwarding	[Disabled]	111
ROM Scan Ordering	[Onboard First]	111
Reset Configuration Data	[No]	112
> SLOT1 PCI-Exp x8		112
Large Disk Access Mode	[Other]	112
<b>Advanced / PCI Configuration / SLOT1 PCI-Exp x8</b>		
Option ROM Scan	[Enabled]	112
Enable Master	[Enabled]	112
Latency Timer	[Default]	112
<b>Advanced /Advanced Chipset Control</b>		
SERR signal condition	[Single bit]	113
4GB PCI Hole Granularity	[256 MB]	113

**Table 6-1** BIOS Default Settings **(continued)**

<b>Menu Item</b>	<b>Setting</b>	<b>Page</b>
Memory Branch Mode	[Interleave]	113
Branch 0 Rank Interleave	[4:1]	113
Branch 0 Rank Sparing	[Disabled]	113
Branch 1 Rank Interleave	[4:1]	113
Branch 1 Rank Sparing	[Disabled]	113
Enhanced x8 Detection	[Enabled]	113
High Bandwidth FSB	[Enabled]	114
High Temp DRAM OP	[Disabled]	114
AMB Thermal Sensor	[Disabled]	114
Thermal Throttle	[Disabled]	114
Global Activation Throttle	[Disabled]	114
Snoop Filter	[Enabled]	114
Crystal Beach Feature	[Enabled]	115
Route Port 80h cycles to	[LPC]	115
Clock Spectrum Feature	[Enabled]	115
High Precision Event Timer	[Yes]	115
USB Function	[Enabled]	115
Legacy USB Support	[Enabled]	115
<b>Advanced / Advanced Processor Options</b>		
CPU Speed	2.33 GHz ( <i>varies</i> )	116
Frequency Ratio	[Default]	116
Core Multi-Processing	[Enabled]	116
Machine Checking	[Enabled]	116
Thermal Management 2	[Enabled]	116

**Table 6-1** BIOS Default Settings **(continued)**

<b>Menu Item</b>	<b>Setting</b>	<b>Page</b>
C1 Enhanced Mode	[Disabled]	116
Execute Disable Bit	[Enabled]	117
Adjacent Cache Line Prefetch	[Disabled]	117
Hardware Prefetcher	[Enabled]	117
Direct Cache Access	[Disabled]	117
Intel(R) Virtualization Technology	[Disabled]	117
Intel EIST support	[Disabled]	118
<b>Advanced / I/O Device Configuration</b>		
Serial port A	[Enabled]	118
Base I/O address	[3F8]	118
Interrupt	[IRQ 4]	118
Serial port B	[Enabled]	118
Mode	[Normal]	118
Base I/O address	[2F8]	118
Interrupt	[IRQ 3]	118
<b>Advanced / DMI Event Logging</b>		
Event log validity	Valid	119
Event log capacity	Space Available	119
View DMI event log	[Enter]	119
Event Logging	[Enabled]	119
ECC Event Logging	[Enabled]	119
Mark DMI events as read	[Enter]	119
Clear all DMI event logs	[No]	119
<b>Advanced / Console Redirection</b>		

**Table 6-1** BIOS Default Settings **(continued)**

<b>Menu Item</b>	<b>Setting</b>	<b>Page</b>
Com Port Address	[On-board COM B]	120
Baud Rate	[115.2K]	120
Console Type	[VT100+]	120
Flow Control	[CTS/RTS]	120
Console connection	[Direct]	120
Continue C.R. after POST	[On]	120
<b>Advanced / Hardware Monitor</b>		
CPU Temperature Threshold	[75C]	121
PECI Agent 1	24 C	
PECI Agent 2	17 C	
System Temperature	26 C	
FAN1 =	10629 RPM	
FAN2 =	9060 RPM	
FAN3 =	10546 RPM	
FAN4 =	9375 RPM	
FAN5 =	10975 RPM	
FAN6 =	9000 RPM	
FAN7 =	N/A	
FAN8 =	N/A	
Fan Speed Control Modes	[1] disable (full speed)]	121
VcoreA	1.198 V	121
VcoreB	1.218 V	121
P1V5	1.504 V	121
+3.3V	3.296 V	121

**Table 6-1** BIOS Default Settings **(continued)**

<b>Menu Item</b>	<b>Setting</b>	<b>Page</b>
+12V	11.904 V	121
5Vsb	4.872 V	121
5VDD	4.968 V	121
P_VTT	1.200 V	121
Vbat	3.296 V	121
<b>Advanced / IPMI</b>		
IPMI Specification Version	2.0	122
Firmware Version	1.25	122
System Event Logging	[Enabled]	122
Clear System Event Log	[Disabled]	123
Existing Event Log number	40	123
SYS Firmware Progress	[Disabled]	123
BIOS POST Errors	[Enabled]	123
BIOS POST Watchdog	[Disabled]	123
OS boot Watchdog	[Disabled]	123
Timer for loading OS (min)	[10]	123
Time out action	[No Action]	123
> System Event Log	Data	124
> System Event Log (list mode)	Data	124
> Realtime Sensor Data	Data	126
<b>Security</b>		
Supervisor Password Is	Clear	127
User Password Is	Clear	127
Set Supervisor Password	[Enter]	127

**Table 6-1** BIOS Default Settings **(continued)**

<b>Menu Item</b>	<b>Setting</b>	<b>Page</b>
Set User Password	[Enter]	127
Password on boot	[Disabled]	127
<b>Boot</b>		128
1: USB FDC		128
2: IDE CD		128
3: USB CDROM		128
4: USB KEY		128
5: ALL PCI BEV		128
6: ALL PCI SCSI		128
7:		128
8:		128
: IDE 0:		128
: IDE 1:		128
: IDE 4:		128
: IDE 5:		128
: USB HDD:		128
: PCI SCSI:	HDT722525DLA380-(S0)	128
: PCI SCSI:	HDS725050KLA360-(S1) (If installed)	128
: USB ZIP:		128
: USB LS120:		128
: Other USB:		128



## System BIOS

The BIOS is the Basic Input Output System used in nearly all computers. The BIOS stores the system parameters, types of disk drives, video displays, etc. in the CMOS. The CMOS memory requires very little electrical power. When the computer is turned off, a backup battery provides power to the CMOS logic, enabling it to retain system parameters. Each time the computer is powered on, the computer is configured with the values stored in the CMOS by the system BIOS, which gains control at boot up.

### How To Change the Configuration Data

The CMOS information that determines the system parameters may be changed by entering the BIOS Setup utility. This Setup utility can be accessed by pressing the <Delete> key at the appropriate time during system boot.

### Starting the Setup Utility

Normally, the only visible power-on self-test (POST) routine is the memory test. As the memory is being tested, press the <Delete> key to enter the main menu of the BIOS Setup utility. From the main menu, you can access the other setup screens, such as the Security and Power menus. Detailed descriptions are provide in the section for each parameter setting in the Setup utility.



---

**Caution:** To prevent possible boot failure, do not shut down or reset the system while updating BIOS.

---

## Running Setup

The BIOS setup options described in this section are selected by choosing the appropriate text from the main BIOS Setup screen. All displayed text is described in this section, although the screen display is often all you need to understand how to set the options.

When you first power on the computer, the BIOS is immediately activated.

While the BIOS is in control, the Setup program can be activated in one of two ways:

1. By pressing <Delete> immediately after turning the system on.
2. When the message shown below is displayed briefly at the bottom of the screen during the power-on self-test (POST), press the <Delete> key to activate the main Setup menu:

Press the <Delete> key to enter Setup

## Main BIOS Setup

The main BIOS Setup screen is displayed in Figure 6-1. All main setup options are described in this section.

- Use the Up/Down arrow keys to move among the different settings in each menu.
- Use the Left/Right arrow keys to change the options for each setting.
- Press the <Esc> key to exit the CMOS Setup Menu. The next section describes in detail how to navigate through the menus.
- Items that use submenus are indicated triangle icon. With the item highlighted, press the <Enter> key to access the submenu.

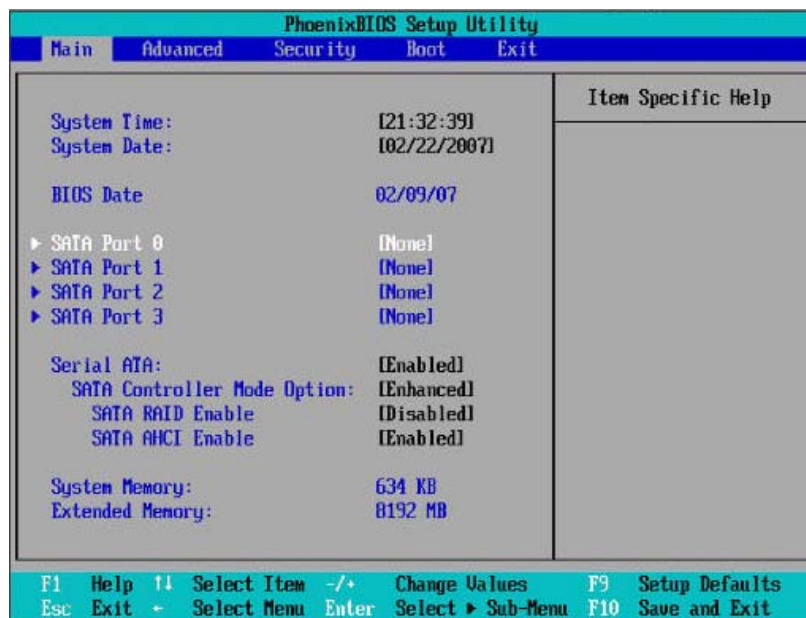

Figure 6-1 Main BIOS Setup Menu

## **Main Setup Features**

### **System Time**

To set the system date and time, type the correct information into the appropriate fields. Then, press the <Enter> key to save the data.

### **System Date**

Using the arrow keys, highlight the month, day, and year fields, and enter the correct data. Press the <Enter> key to save the data.

### **BIOS Date**

This field displays the date when this version of BIOS was built.

## Serial ATA Ports

These settings allow the user to set the parameters of the SATA ports. Press <Enter> to activate the following submenu screen for detailed options of these items. Set the correct configurations accordingly.

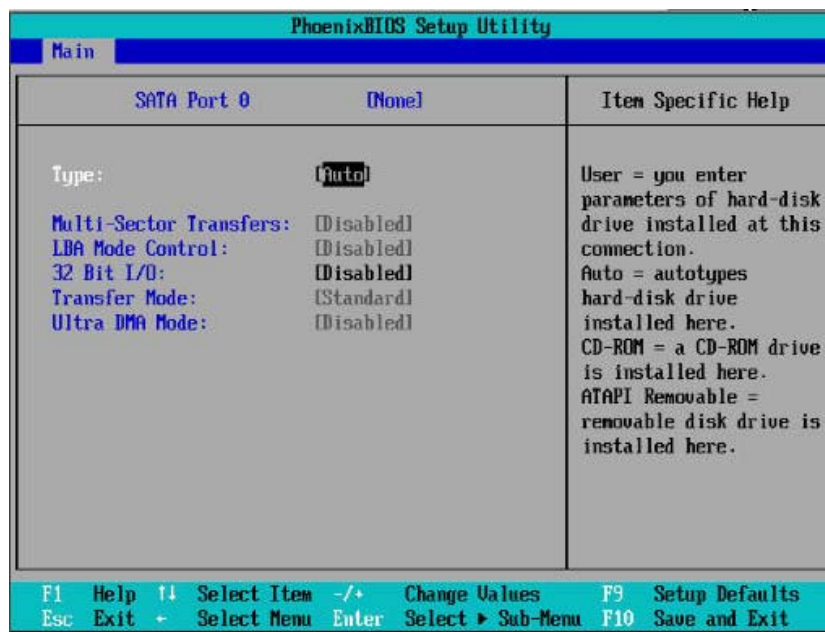

## Type

This option enables you to select the type of IDE hard drive. The option `Auto` enables the BIOS to automatically configure the parameters of the hard disk drive (HDD) installed at the connection. Enter a number between 1 to 39 to select a predetermined HDD type. Select `User` to allow the user to enter the parameters of the HDD installed.

### **Multi-Sector Transfers**

This item enables you to specify the number of sectors per block to be used in multi-sector transfer. The options are Disabled, 4 Sectors, 8 Sectors, and 16 Sectors.

### **LBA Mode Control**

This item determines whether the BIOS accesses the IDE Channel 0 Master Device via the LBA mode. The options are Enabled and Disabled.

### **32 Bit I/O**

This option enables you to enable or disable the function of 32-bit data transfer. The options are Enabled and Disabled.

### **Transfer Mode**

This option allows the user to set the transfer mode. The options are Standard, Fast PIO1, Fast PIO2, Fast PIO3, Fast PIO4, FPIO3/DMA1 and FPIO4/DMA2.

### **Ultra DMA Mode**

This option allows the user to select Ultra DMA Mode. The options are Disabled, Mode 0, Mode 1, Mode 2, Mode 3, Mode 4, and Mode 5.

### **Native Mode Operation**

Select the native mode for ATA. The options are: Serial ATA and Auto.

### **SATA Controller Mode**

Select Compatible to allow the SATA and PATA drives to be automatically-detected and be placed in the Legacy Mode by the BIOS. Select Enhanced to allow the SATA and PATA drives to be to be automatically-detected and be placed in the Native IDE Mode.

---

When the SATA Controller Mode is set to Enhanced, the following items are displayed.

---

**Note:** The SATA RAID functions were not supported when this manual was published. Check with SGI Global Customer Service to verify that the SATA RAID features are fully supported.

---

### **Serial ATA (SATA) RAID Enable**

Select Enable to enable Serial ATA RAID functions. (For the Windows OS environment, use the RAID driver if this feature is set to Enabled. When this item is set to Enabled, the item: "ICH RAID Code Base" is available for you to select Intel or Adaptec Host RAID firmware to be activated. If this item is set to Disabled, the item-SATA AHCI Enable is available.) The options are Enabled and Disabled.

### **ICH RAID Code Base (Available when SATA RAID is Enabled)**

Select Intel to enable the Intel SATA RAID firmware. Select Adaptec to use the Adaptec HostRAID firmware. The options are Intel and Adaptec.

### **SATA AHCI (Available when SATA RAID is Disabled)**

Select Enable to enable the function of Serial ATA Advanced Host Interface. (**Use caution when using this function. This feature is for advanced programmers only.**) The options are Enabled and Disabled.

### **System Memory**

This display informs you how much system memory is recognized as being present in the system.

### **Extended Memory**

This display informs you how much extended memory is recognized as being present in the system.

## Advanced Setup

Choose Advanced from the BIOS Setup Utility main menu with the arrow keys. The items with a triangle beside them have submenus that can be accessed by highlighting the item and pressing <Enter>.

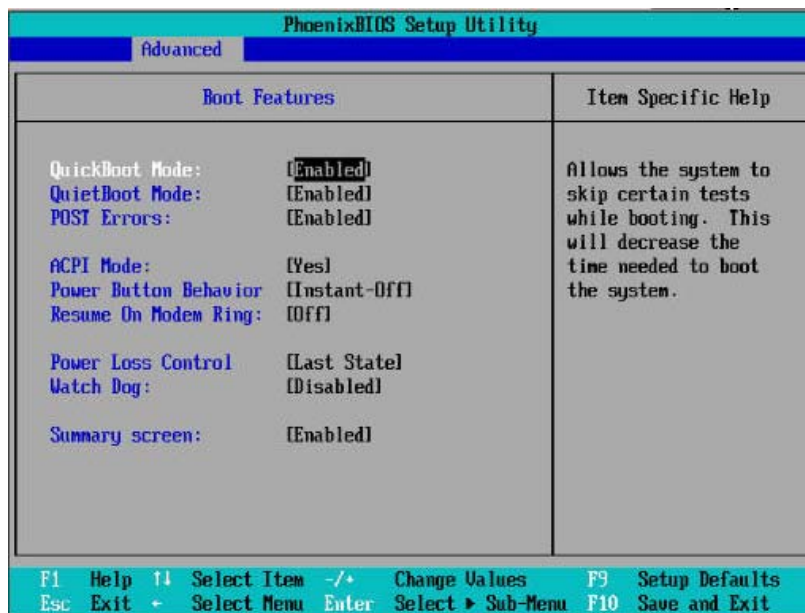

### Boot Features

Access the submenu to make changes to the following settings.

#### QuickBoot Mode

If enabled, this feature speeds up the POST routine by skipping certain tests after the computer is turned on. The settings are Enabled and Disabled. If Disabled, the POST routine will run at normal speed.

#### QuietBoot Mode

This setting enables you to Enable or Disable the graphic logo screen during boot-up.



**POST Errors**

Set to Enabled to display POST Error Messages if an error occurs during bootup. If set to Disabled, the system will continue to boot without displaying any error message even when a boot error occurs.

**ACPI Mode**

Use this setting to determine if you want to employ ACPI (Advanced Configuration and Power Interface) power management on your system. The options are Yes and No.

**Power Button Behavior**

If set to Instant-Off, the system will power off immediately as soon as the user hits the power button. If set to 4-sec., the system will power off when the user presses the power button for 4 seconds or longer. The options are instant-off and 4-second override.

**Resume On Modem Ring**

Select On to “wake your system up” when an incoming call is received by your modem. The options are On and Off.

**Power Loss Control**

The feature allows the user to set the power state after a power outage. You can select Stay Off for the system power to remain off after a power loss. Select Power On for the system power to be turned on after a power loss. Select Last State to allow the system to resume its last state before the power loss.

**Watch Dog**

If enabled, this option automatically resets the system if the system is not active for more than 5 minutes. The options are Enabled and Disabled.

**Summary Screen**

This setting enables you to Enable or Disable the summary screen, which displays the system configuration during bootup.

## Memory Cache

### Cache System BIOS Area

This setting enables you to designate a reserve area in the system memory to be used as a System BIOS buffer to allow BIOS to write (cache) its data into it. Select Write Protect to enable the function and reserve this area for system BIOS ROM access only. Select Uncached to disable this function and make this area available for other devices.

### Cache Base 0-512K

If enabled, this feature will allow the data stored in the base memory area: block 0-512K to be cached (written) into a buffer, a storage area in the Static DRAM (SDROM), or to be written into L1 or L2 cache inside the CPU to speed up CPU's operations. Select Uncached to disable this function. Select Write Through to allow data to be cached into the buffer and written into the system memory at the same time. Select Write Protect to prevent data from being written into the base memory area of Block 0-512K. Select Write Back to allow the CPU to write data back directly from the buffer without writing data to the system memory in order to speed up CPU's operation. The options are Uncached, Write Through, Write Protect, and Write Back.

### Cache Base 512K-640K

If enabled, this feature will allow the data stored in the memory area: 512K-640K to be cached (written) into a buffer, a storage area in the SDRAM or written into L1, L2, or L3 cache inside the CPU to speed up CPU operations. Select Uncached to disable this function. Select Write Through to allow data to be cached into the buffer and written into the system memory at the same time. Select Write Protect to prevent data from being written into the base memory area of Block 512-640K. Select Write Back to allow the CPU to write data back directly from the buffer without writing data to the system memory to speed up CPU's operation. The options are Uncached, Write Through, Write Protect, and Write Back.

### Cache Extended Memory

If enabled, this feature will allow the data stored in the extended memory area to be cached (written) into a buffer, a storage area in the Static DRAM (SDROM), or written into L1, L2, or L3 cache inside the CPU to speed up CPU's operations. Select Uncached to disable this function. Select Write Through to allow data to be cached into the buffer and written into the system memory at the same time. Select Write Protect to prevent data from being written into the base memory area of Block 0-512K. Select Write Back to allow the CPU to write data back directly

from the buffer without writing data to the system memory to speed up CPU's operation. The options are Uncached, Write Through, Write Protect and Write Back.

## **PCIe Configuration**

Access the submenu to make changes to the following settings for PCIe devices.

### **Onboard GLAN1/Onboard GLAN2 (Gigabit- LAN) OPROM Configure**

Enabling this option provides the capability to boot from GLAN Port 1 or GLAN Port 2. The options are Disabled and Enabled.

### **Default Primary Video Adapter**

This feature allows the user to specify which video adapter is to be used as the default primary video adapter: the onboard video adapter or others. The options are Other and Onboard Video.

### **Emulated IRQ Solutions**

The options are Disabled and Enabled.

### **PCIe I/O Performance**

Some add-on cards perform faster with the coalesce feature, which limits the payload size to 128 bytes, while others perform faster with a payload size of 256 bytes, which inhibits coalesce features. Please refer to your add-on card user guide for the desired setting. The options are Payload (256 bytes) and Coalesce Enabled (128 bytes).

### **PCIe Parity Error Forwarding**

The feature allows SERR and PERR errors detected in PCIe slots to be sent (forwarded) to the BIOS DMI Event Log for the user to review. The options are Enabled and Disabled.

### **ROM Scan Ordering**

This feature allows the user to decide which Option ROM should be activated first. The options are Onboard first and Add-On first.

### **Reset Configuration Data**

If set to Yes, this setting clears the Extended System Configuration Data- (ESCD) area. The options are Yes and No.

### **Slot1 PCIe x8**

Access the submenu for each of the settings above to make changes to the following:

### **Option ROM Scan**

When enabled, this setting will initialize the device expansion ROM. The options are Enabled and Disabled.

### **Enable Master**

This setting enables you to enable the selected device as the PCI bus master. The options are Enabled and Disabled.

### **Latency Timer**

This setting enables you to set the clock rate for Bus Master. A high-priority, high throughput device may benefit from a greater clock rate. The options are Default, 0020h, 0040h, 0060h, 0080h, 00A0h, 00C0h, and 00E0h. For Unix, Novell and other Operating Systems, please select the option: other. If a drive fails after the installation of a new software, you might want to change this setting and try again. A different OS requires a different Bus Master clock rate.

### **Large Disk Access Mode**

This setting determines how large a hard drive is to be accessed. The options are DOS or Other (for Unix, Novell NetWare, and other operating systems).

### **Advanced Chipset Control**

Access the submenu to make changes to the following settings.



---

**Caution:** Use caution when changing the Advanced settings. Incorrect values entered may cause a system to malfunction. Also, a very high DRAM frequency or incorrect DRAM timing may cause system to become unstable. When this occurs, revert the item to the default setting.

---

### **SERR Signal Condition**

This setting specifies the ECC Error conditions. The options are None, Single Bit, Multiple Bit, and Both.

### **4GB PCIe Hole Granularity**

This feature enables you to specify the size of PCIe hole. The options are: 256 MB, 512 MB, 1GB and 2GB.

### **Memory Branch Mode**

This option determines how the two memory branches operate. System address space can either be interleaved between the two branches or Sequential from one branch to another. Mirror mode allows data correction by maintaining two copies of data in two branches. Single Channel 0 allows a single DIMM population during system manufacturing. The options are Interleave, Sequential, Mirroring, and Single Channel 0.

### **Branch 0/1 Rank Interleaving**

Select Enabled to enable the feature of memory Interleaving for Branch 0 Rank/ Branch1 Rank. The options are 1:1, 1:2 and 1:4.

### **Branch 0/1 Rank Sparing**

Select Enabled to enable the sparing feature for Branch 0 Rank/Branch 1 Rank. The options are Enabled and Disabled.

### **Enhanced x8 Detection**

Select Enabled to enable Enhanced x8 DRAM UC Error Detection. The options are Disabled and Enabled.

### **High Bandwidth FSB**

The front side bus (FSB) is the physical bi-directional data bus that carries signals between the central processing unit (CPU) and other devices within the system, such as random access memory (RAM), AGP video cards, PCI expansion cards, hard disks, the memory containing the system BIOS, etc. A higher bandwidth FSB improves performance of the system. The options are Enabled and Disabled.

### **High Temperature DRAM Operation**

When set to Enabled, the BIOS will refer to the SPD table to set the maximum DRAM temperature. When set to Disabled, the BIOS sets the maximum DRAM temperature based on a predefined value. The options are Enabled and Disabled.

### **AMB Thermal Sensor**

Select Enabled to enable the thermal sensor embedded in the Advanced Memory Buffer on a fully buffered memory module for thermal monitoring. The options are Disabled and Enabled.

### **Thermal Throttle**

Select Enabled to enable the function of closed-loop thermal throttling on a fully buffered (FBD) memory module. In the closed-loop thermal environment, thermal throttling will be activated when the temperature of the FBD DIMM device exceeds a predefined threshold. The options are Enabled and Disabled.

### **Global Activation Throttle**

Select Enabled to enable open-loop global thermal throttling on a fully buffered (FBD) memory module to make it active whenever the number of activate control exceeds a predefined number. The options are Enabled and Disabled.

### **Snoop Filter**

Select Enabled to eliminate snoop traffic to the graphics port to improve system performance when running graphics intensive applications. The options are Enabled and Disabled.

## Crystal Beach Features

This feature was designed to implement Intel's I/O AT (Acceleration Technology) to accelerate the performance of TCP offload engine (TOE) devices.

---

**Note:** A TOE device is a specialized, dedicated processor that is installed on an add-on card or a network card to handle some or all packet processing of the add-on card. For this motherboard, the TOE device is built inside the ESB2 southbridge chip. The options are Enabled and Disabled.

---

## Route Port 80h Cycles to

This feature allows the user to decide which bus to send debug information to. The options are Disabled, PCI, and LPC.

## Clock Spectrum Feature

If Enabled, the BIOS will monitor the level of Electromagnetic Interference caused by the components and will attempt to decrease the interference whenever needed. The options are Enabled and Disabled.

## High Precision Event Timer

This is a replacement timer for the 8254 Programmable Interval Timer and the Real-time clock's (RTC) periodic interrupt function. The high-precision event timer (HPET) can produce periodic interrupts at much higher resolutions than the RTC interrupt function. The HPET is used to synchronize multimedia streams and provide smooth playback which reduces the need to use other timestamp calculations such as the Intel x86 RDTSC instruction.

## USB Function

Select Enabled to enable the function of USB devices specified. The settings are Enabled and Disabled.

## Legacy USB Support

This setting enables you to enable Legacy USB device support. The settings are Enabled and Disabled.

## Advanced Processor Options

### CPU Speed

This is a display that indicates the speed of the installed processor.

### Frequency Ratio

This feature enables you to set the internal frequency multiplier for the CPU. The options are: Default, x12, x13, x14, x15, x16, x17 and x18.

### Core-Multi-Processing

Set to Enabled to use a processor's second core and beyond. (Please refer to Intel's web site for more information.) The options are Disabled and Enabled.

### Machine Checking

Set to Enabled to activate the function of Machine Checking and allow the CPU to detect and report hardware (machine) errors via a set of model-specific registers (MSRs). The options are Disabled and Enabled.

### Thermal Management 2

Set to Enabled to use Thermal Management 2 (TM2), which will lower CPU voltage and frequency when the CPU temperature reaches a predefined overheat threshold. Set to Disabled to use Thermal Manager 1 (TM1), allowing CPU clocking to be regulated via CPU Internal Clock modulation when the CPU temperature reaches the overheat threshold.

### C1 Enhanced Mode

Select Disable to disable the Standard C1 Halt State, which will partially turn off the CPU internal clocks to conserve energy and prevent system overheating when the OS is idle. Select Enable to use the Enhanced C1 Halt State to lower the CPU clock frequency and the supply voltage before turning off the clocks.



### Execute Disable Bit

Set to Enabled to enable Execute Disable Bit and allow the processor to classify areas in memory where an application code can be executed and where it cannot, and thus preventing a worm or a virus from inserting and creating a flood of codes to overwhelm the processor or damage the system during an attack. The options are Disabled and Enabled.

### Adjacent Cache Line Prefetch

The CPU fetches the cache line for 64 bytes if this option is set to Disabled. The CPU fetches both cache lines for 128 bytes as comprised if Enabled. The options are Disabled and Enabled.

### Hardware Prefetch

Set this option to Enabled to enable the hardware components that are used in conjunction with software programs to prefetch data in order to shorten execution cycles and maximize data processing efficiency. The options are Disabled and Enabled.

### Direct Cache Access

Set to Enable to route inbound network IO traffic directly into processor caches to reduce memory latency and improve network performance. The options are Disabled and Enabled.

### DCA Delay Clocks

This feature allows the user to set the clock delay setting from snoop to prefetch for Direct Cache Access. Select a setting from 8 (bus cycles) to 120 (bus cycles) (in 8-cycle increment). The default setting is 32 (bus cycles).

### Intel Virtualization Technology

Select Enabled to use the Intel Virtualization Technology and enable one platform to run multiple operating systems and applications in independent partitions, creating multiple “virtual” systems in one physical computer. The options are Enabled and Disabled.

---

**Note:** If there is any change to this setting, you must power off and restart the system for the change to take effect.

---

## Intel EIST Support

Select Enabled to use the Enhanced Intel SpeedStep Technology and enable the system to automatically adjust processor voltage and core frequency in an effort to reduce power consumption and heat dissipation. The options are Enabled and Disabled.

## I/O Device Configuration

Access the submenu to make changes to the following settings.

### Serial Port A

This setting enables you to assign control of serial port A. The options are Enabled (user defined), Disabled, Auto (BIOS controlled), and OS Controlled.

#### **Base I/O Address**

This setting enables you to select the base I/O address for serial port A. The options are 3F8, 2F8, 3E8, and 2E8.

#### **Interrupt**

This setting enables you to select the IRQ (interrupt request) for serial port B. The options are IRQ3 and IRQ4.

### Serial Port B

This setting enables you to assign control of serial port B. The options are Enabled (user defined), Disabled, Auto (BIOS controlled), and OS Controlled.

#### **Mode**

This setting enables you to set the type of device that will be connected to serial port B. The options are Normal, IR (for an infrared device), and ASK\_IR.

#### **Base I/O Address**

This setting enables you to select the base I/O address for serial port B. The options are 3F8, 2F8, 3E8, and 2E8.

#### **Interrupt**

This setting enables you to select the IRQ (interrupt request) for serial port B. The options are IRQ3 and IRQ4.

## **DMI Event Logging**

Access the submenu to make changes to the following settings.

### **Event Log Validity**

This is a display to inform you of the event log validity. It is not a setting.

### **Event Log Capacity**

This is a display to inform you of the event log capacity. It is not a setting.

### **View DMI Event Log**

Highlight this item and press <Enter> to view the contents of the event log.

### **Event Logging**

This setting enables you to Enable or Disable event logging.

### **ECC Event Logging**

This setting enables you to Enable or Disable ECC event logging.

### **Mark DMI Events as Read**

Highlight this item and press <Enter> to mark the DMI events as read.

### **Clear All DMI Event Logs**

Select Yes and press <Enter> to clear all DMI event logs. The options are Yes and No.

## **Console Redirection**

Access the submenu to make changes to the following settings.

### COM Port Address

This item enables you to specify which COM port to direct the remote console to: Onboard COM A or Onboard COM B. This setting can also be Disabled.

### BAUD Rate

This item enables you to set the BAUD rate for console redirection. The options are 300, 1200, 2400, 9600, 19.2K, 38.4K, 57.6K, and 115.2K.

### Console Type

This item enables you to set console redirection type. The options are VT100, VT100,8bit, PC-ANSI, 7bit, PC ANSI, VT100+, VT-UTF8, and ASCII.

### Flow Control

This item enables you to select the flow control option for console redirection. The options are None, XON/XOFF, and CTS/RTS.

### Console Connection

This item enables you to decide how console redirection is to be connected: either Direct or Via Modem.

### Continue CR after POST

Choose whether to continue with console redirection after the POST routine. The options are On and Off.

### Hardware Monitor

---

**Note:** The BIOS automatically detects the type of CPU(s) and hardware monitoring chips that are used on the motherboard and displays the Hardware Monitoring Screen accordingly. The Hardware Monitoring Screen may look different than one shown on the following pages.

---

## CPU Temperature Threshold

This option allows the user to set a CPU temperature threshold that will activate the alarm system when the CPU temperature reaches this pre-set temperature threshold. The options are 70°C, 75°C, 80°C, and 85°C.

Highlight this and press <Enter> to view monitor data for the following items:

- CPU1 Temperature
- CPU1 Second Core
- CPU2 Temperature
- CPU2 Second Core
- System Temperature
- Fan1-Fan8 Speeds: If the feature of Auto Fan Control is enabled, the BIOS will automatically display the status of the fans indicated in this item.

## Fan Speed Control Modes

This feature allows the user to decide how the system controls the speeds of the onboard fans. The CPU temperature and the fan speed are correlative. When the CPU on-die temperature increases, the fan speed will also increase, and vice versa. Select Workstation if your system is used as a Workstation. Select Server if your system is used as a Server. Select 3-pin if your chassis uses 3-pin fans. Select 4-pin if your chassis uses 4-pin fans. Select “Disable” to disable the fan speed control function and allow the onboard fans to constantly run at the full speed (12V). The Options are: 1. Disable, 2. Optimized Server w/3-pin, 3. Optimized Workstation w/3-pin, 4. Optimized Server w/4-pin, and 5. Optimized Workstation w/4-pin.

## Voltage Monitoring

The following items are monitored and displayed:

- Vcore A
- Vcore B
- P1V5
- +3.3V
- +12V
- 5Vsb
- 5VDD
- P\_VTT

- Vbat

## IPMI

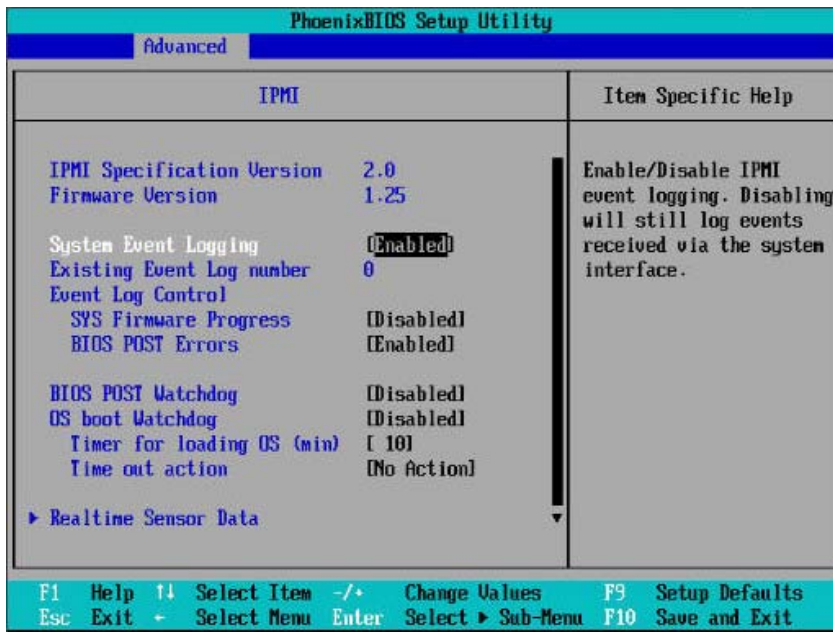

### IPMI Specification Version

This item displays the current IPMI Version.

### Firmware Version

This item displays the current Firmware Version.

### System Event Logging

Select Enabled to enable IPMI Event Logging. When this function is set to Disabled, the system will continue to log events received via system interface. The options are Enabled and Disabled.

## Clear System Event Logging

Enable this function to force the BIOS to clear the system event logs during the next cold boot. The options are Enabled and Disabled.

## Existing Event Log Number

This item displays the number of the existing event log.

## Event Log Control

### System Firmware Progress

Enable this function to log POST progress. Options are Enabled and Disabled.

### BIOS POST Errors

Enable this function to log POST errors. Options are Enabled and Disabled.

### BIOS POST Watch Dog

Set to Enabled to enable POST Watch Dog. Options are Enabled and Disabled.

### OS Boot Watch Dog

Set to Enabled to enable OS Boot Watch Dog. The options are Enabled and Disabled.

### Timer for Loading OS (Minutes)

This feature allows the user to set the time value (in minutes) for the previous item: OS Boot Watch Dog by keying-in a desired number in the blank. The default setting is 10 minutes. **Ignore this option when OS Boot Watch Dog is set to Disabled.**

### Time Out Option

This feature allows the user to determine what action to take in an event of a system boot failure. The options are No Action, Reset, Power Off, and Power Cycles.

## System Event Log/System Event Log (List Mode)

These options display the System Event (SEL) Log and System Event (SEL) Log in List Mode. Items include: SEL (System Event Log) Entry Number, SEL Record ID, SEL Record Type, Time Stamp, Generator ID, SEL Message Revision, Sensor Type, Sensor Number, SEL Event Type, Event Description, and SEL Event Data.

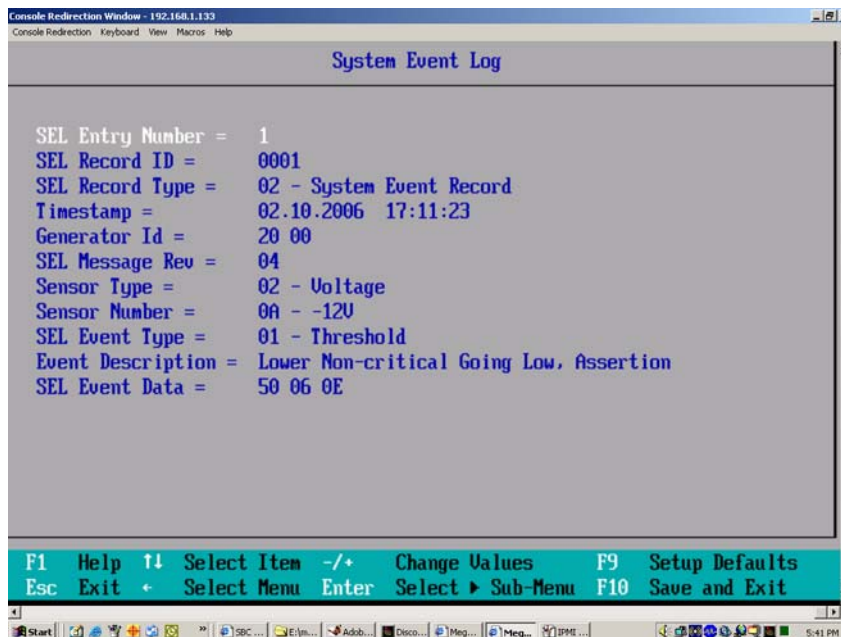



## Realtime Sensor Data

This feature display information from motherboard sensors, such as temperatures, fan speeds, and voltages of various components.

Sensor Type	Sensor Name	Sensor Data	Sensor Units	Lower Limit	Upper Limit
<b>Temp</b>					
	CPU1 CoreA	48.00	degrees C	0.00	75.00
	CPU1 CoreB	54.00	degrees C	0.00	75.00
	CPU2 CoreA	47.00	degrees C	0.00	75.00
	CPU2 CoreB	46.00	degrees C	0.00	75.00
	System	44.00	degrees C	0.00	75.00
<b>Voltage</b>					
	CPU1 Core	1.13	Volts	0.97	1.47
	CPU2 Core	1.16	Volts	0.97	1.47
	3.30	3.30	Volts	2.95	3.62

F1	Help	↑↓	Select Item	-/+	Change Values	F9	Setup Defaults
Esc	Exit	←	Select Menu	Enter	Select ▶ Sub-Menu	F10	Save and Exit

## Security

Choose Security from the BIOS Setup Utility main menu with the arrow keys. Security setting options are displayed by highlighting the setting using the arrow keys and pressing <Enter>. All Security BIOS settings are described in this section.

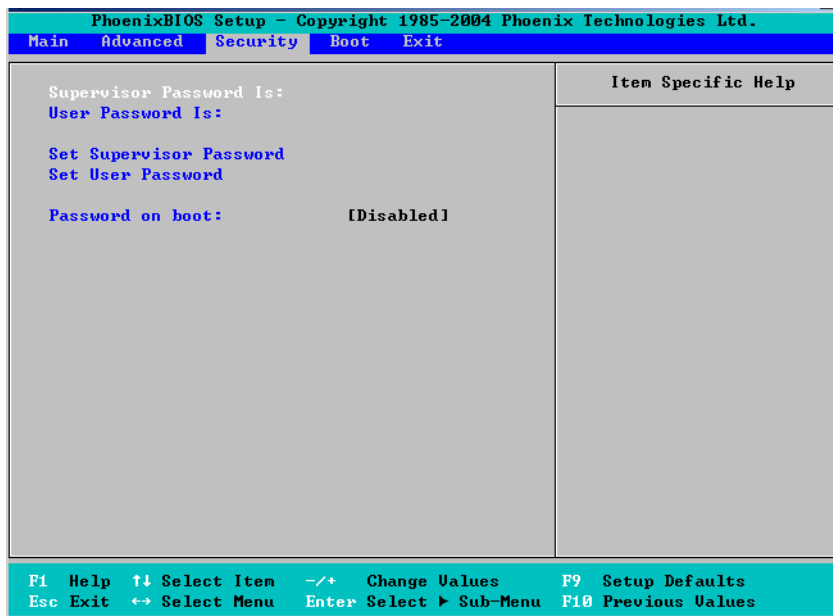

### Supervisor Password Is

This displays whether a supervisor password has been entered for the system. Clear means such a password has not been used, and Set means a supervisor password has been entered for the system.

### User Password Is

This displays whether a user password has been entered for the system. Clear means such a password has not been used, and Set means a user password has been entered for the system.

## Set Supervisor Password

When the item “Set Supervisor Password” is highlighted, press the <Enter> key. When prompted, type the Supervisor’s password in the dialogue box to set or to change the supervisor’s password, which allows access to the BIOS.

## Set User Password

When the item “Set User Password” is highlighted, press the <Enter> key. When prompted, type the user’s password in the dialogue box to set or to change the user’s password, which allows access to the system at boot-up.

## Password on Boot

This setting enables you to require a password to be entered when the system boots up. The options are Enabled (password required) and Disabled (password not required).

## Boot

Choose Boot from the BIOS Setup Utility main menu with the arrow keys. For details on how to change the order and specs of boot devices, refer to the Item Specific Help window. All Boot BIOS settings are described in this section.

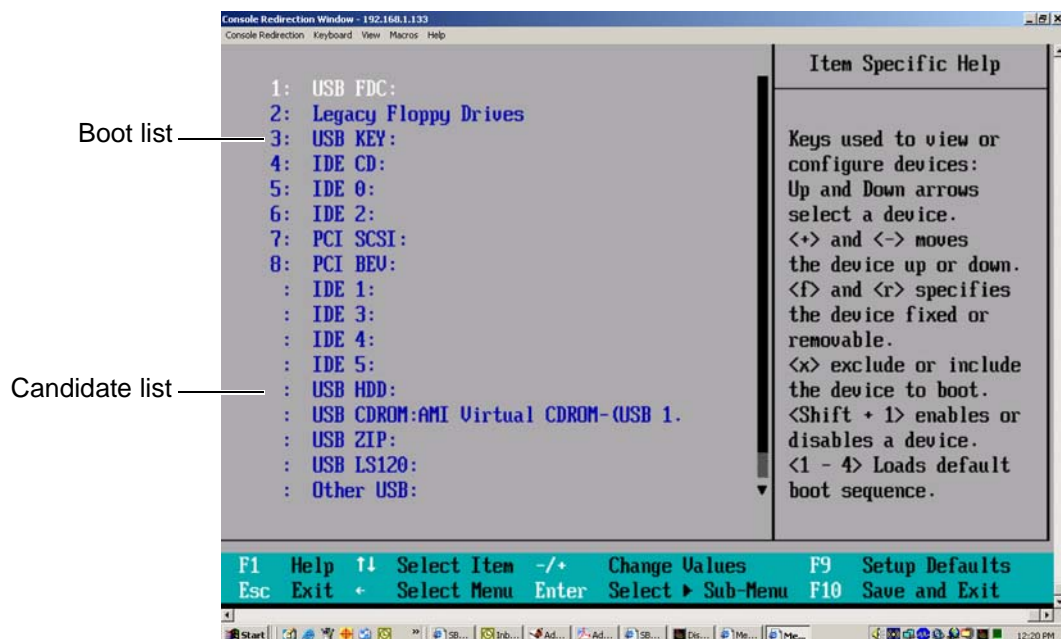

### Boot Priority Order/Excluded from Boot Orders

The devices included in the boot list section (above) are bootable devices listed in the sequence of boot order as specified. The boot functions for the devices included in the candidate list (above) are currently disabled. Use a <+> key or a <-> key to move the device up or down. Use the <f> key or the <r> key to specify the type of an USB device, either fixed or removable. You can select one item from the boot list and press the <x> key to remove it from the list of bootable devices (to make its resource available for other bootable devices). Subsequently, you can select an item from the candidate list and press the <x> key to remove it from the candidate list and put it in the boot list. This item will then become a bootable device. For details on changing the boot priority order of a device, refer to the “Item Specific Help” window.

## Exit

Choose Exit from the BIOS Setup Utility main menu with the arrow keys. All Exit BIOS settings are described in this section.

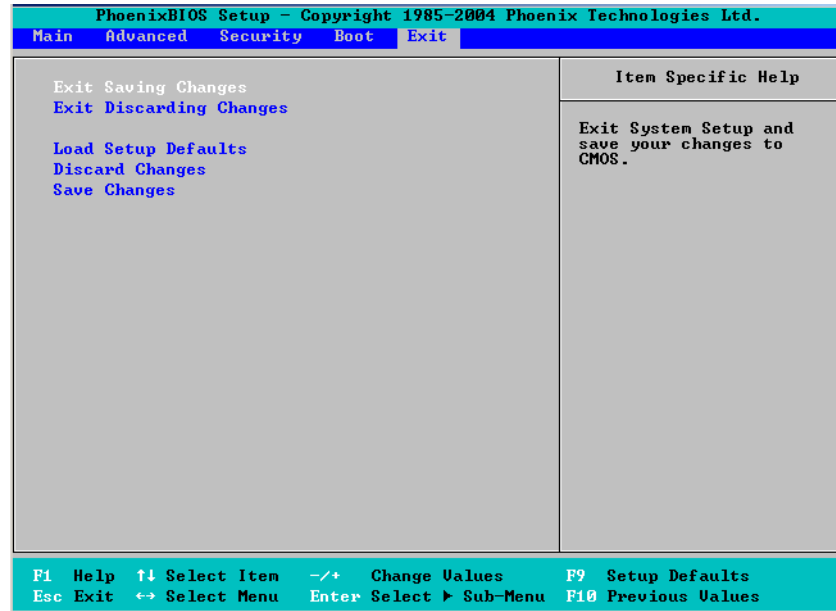

## **Exit Saving Changes**

Highlight this item and press <Enter> to save any changes you have made and to exit the BIOS Setup utility.

## **Exit Discarding Changes**

Highlight this item and press <Enter> to exit the BIOS Setup utility without saving any changes you may have made.

## **Load Setup Defaults**

Highlight this item and press <Enter> to load the default settings for all items in the BIOS Setup. These are the safest settings to use.

## **Discard Changes**

Highlight this item and press <Enter> to discard (cancel) any changes you've made. You will remain in the Setup utility.

## **Save Changes**

Highlight this item and press <Enter> to save any changes you've made. You will remain in the Setup utility.

## BIOS Power-on Self Test

This appendix lists and describes the BIOS power-on self-test (POST) messages and codes.

### BIOS POST Messages

During POST, the BIOS checks the hardware and software systems for problems. If a problem is found, the BIOS activates an alarm or displays a message. The following is a list of the BIOS messages from the POST sequence.

Failure Fixed Disk

Fixed disk is not working or not configured properly. Verify that the fixed disk is attached properly. Run BIOS Setup. Find out if the fixed-disk type is correctly identified.

Stuck key

Stuck key on keyboard.

Keyboard error

Keyboard not working.

Keyboard Controller Failed

Keyboard controller failed test. May require replacing keyboard controller.

Keyboard locked - Unlock key switch

Unlock the system to proceed.

Monitor type does not match CMOS - Run SETUP

Monitor type not correctly identified in Setup

Shadow Ram Failed at offset: *nnnn*

Shadow RAM failed at offset *nnnn* of the 64k block at which the error was detected.

System RAM Failed at offset: *nnnn*

System RAM failed at offset *nnnn* of in the 64k block at which the error was detected.

Extended RAM Failed at offset: *nnnn*

Extended memory not working or not configured properly at offset *nnnn*.

System battery is dead - Replace and run SETUP

The CMOS clock battery indicator shows the battery is dead. Replace the battery and run Setup to reconfigure the system.

System CMOS checksum bad - Default configuration used

System CMOS has been corrupted or modified incorrectly, perhaps by an application program that changes data stored in CMOS. The BIOS installed Default Setup Values. If you do not want these values, enter Setup and enter your own values. If the error persists, check the system battery or contact SGI technical support.

System timer error

The timer test failed. Requires repair of system board.

Real time clock error

Real-Time Clock fails BIOS hardware test. May require board repair.

Check date and time settings

BIOS found date or time out of range and reset the Real-Time Clock. May require setting legal date (1991-2099).

Previous boot incomplete - Default configuration used

Previous POST did not complete successfully. POST loads default values and offers to run Setup. If the failure was caused by incorrect values and they are not corrected, the next boot will likely fail. On systems with control of wait states,



improper Setup settings can also terminate POST and cause this error on the next boot. Run Setup and verify that the waitstate configuration is correct. This error is cleared the next time the system is booted.

Memory Size found by POST differed from CMOS

Memory size found by POST differed from CMOS.

System cache error - Cache disabled

RAM cache failed and BIOS disabled the cache. On older boards, check the cache jumpers. You may have to replace the cache. Contact SGI customer service. A disabled cache slows system performance considerably.

CPU ID:

CPU socket number for Multi-Processor error.

EISA CMOS not writeable

ServerBIOS2 test error: Cannot write to EISA CMOS.

DMA Test Failed

ServerBIOS2 test error: Cannot write to extended DMA (Direct Memory Access) registers.

Software NMI Failed

ServerBIOS2 test error: Cannot generate software NMI (Non-Maskable Interrupt).

Fail-Safe Timer NMI Failed

ServerBIOS2 test error: Fail-Safe Timer takes too long for specified device.

Address Conflict

Address conflict for specified device.

Allocation Error for: *device*

Run ISA or EISA Configuration Utility to resolve resource conflict for the specified device.

CD ROM Drive

CD ROM drive identified.

Entering SETUP...

Starting Setup program

Failing Bits: *nnnn*

The hex number *nnnn* is a map of the bits at the RAM address which failed the memory test. Each 1 (one) in the map indicates a failed bit. Refer to “Shadow Ram Failed at offset: *nnnn*” error descriptions on page 132 for offset address of the failure in System, Extended, or Shadow memory.

Fixed Disk *n*

Fixed disk *n* (0-3) identified.

Invalid System Configuration Data

Problem with NVRAM (CMOS) data.

I/O device IRQ conflict

I/O device IRQ conflict error.

PS/2 Mouse Boot Summary Screen:

PS/2 Mouse installed.

*nnnn* kB Extended RAM Passed

Where *nnnn* is the amount of RAM in kilobytes successfully tested.

*nnnn* Cache SRAM Passed

Where *nnnn* is the amount of system cache in kilobytes successfully tested.

*nnnn* kB Shadow RAM Passed

Where *nnnn* is the amount of shadow RAM in kilobytes successfully tested.

*nnnn* kB System RAM Passed

Where *nnnn* is the amount of system RAM in kilobytes successfully tested.

One or more I2O Block Storage Devices were excluded from the Setup Boot Menu

There was not enough room in the IPL table to display all installed I2O block-storage devices.

Operating system not found

Operating system cannot be located on either drive A: or drive C:. Enter Setup and verify that the fixed disk and drive A: are properly identified.

Parity Check 1 *nnnn*

Parity error found in the system bus. BIOS attempts to locate the address and display it on the screen. If it cannot locate the address, it displays ????. Parity is a method for checking errors in binary data. A parity error indicates that some data has been corrupted.

Parity Check 2 *nnnn*

Parity error found in the I/O bus. BIOS attempts to locate the address and display it on the screen. If it cannot locate the address, it displays ????.

Press <F1> to resume, <F2> to Setup, <F3> for previous

Displayed after any recoverable error message. Press <F1> to start the boot process or <F2> to enter Setup and change the settings. Press <F3> to display the previous screen (usually an initialization error of an Option ROM—that is, an add-on card). Write down and follow the information shown on the screen.

Press <F2> to enter Setup

Optional message displayed during POST. Can be turned off in Setup.

PS/2 Mouse:

PS/2 mouse identified.

Run the I2O Configuration Utility

One or more unclaimed block storage devices have the Configuration Request bit set in the LCT. Run an I2O configuration program; for example, the system address controller (SAC) utility.

System BIOS shadowed

System BIOS copied to shadow RAM.

UMB upper limit segment address: *nnnn*

Displays the address *nnnn* of the upper limit of Upper Memory Blocks, indicating released segments of the BIOS which can be reclaimed by a virtual memory manager.

Video BIOS shadowed

Video BIOS successfully copied to shadow RAM.

## BIOS POST Codes

This section lists the power on self test (POST) codes for the BIOS. The POST codes are divided into two categories: recoverable and terminal.

### Recoverable POST Errors

When a recoverable type of error occurs during POST, the BIOS will display a POST code that describes the problem. BIOS may also issue one of the following beep codes:

- 1 long and two short beeps - video configuration error
- 1 repetitive long beep - no memory detected

### Terminal POST Errors

If a terminal type of error occurs, BIOS shuts down the system. Before doing so, BIOS writes the error to port 80h, attempts to initialize video, and writes the error in the top left corner of the screen. Table A-1 lists the codes that may be written to port 80h.

**Table A-1** BIOS Post Codes

POST Code	Description
01	PMI Initialization
02	Verify Real Mode
03	Disable Non-Maskable Interrupt (NMI)
04	Get CPU type
06	Initialize system hardware
07	Disable shadow and execute code from the ROM
08	Initialize chipset with initial POST values
09	Set IN POST flag
0A	Initialize CPU registers
0B	Enable CPU cache

**Table A-1** BIOS Post Codes **(continued)**

<b>POST Code</b>	<b>Description</b>
0C	Initialize caches to initial POST values
0E	Initialize I/O component
0F	Initialize the local bus IDE
10	Initialize Power Management
11	Load alternate registers with initial POST values
12	Restore CPU control word during warm boot
13	Reset PCI Bus Mastering devices
14	Initialize keyboard controller
16	1-2-2-3 BIOS ROM checksum
17	Initialize cache before memory Auto size
18	8254 timer initialization
1A	8237 DMA controller initialization
1C	Reset Programmable Interrupt Controller
20	1-3-1-1 Test DRAM refresh
22	1-3-1-3 Test 8742 Keyboard Controller
24	Set ES segment register to 4 GB
28	Auto size DRAM
29	Initialize POST Memory Manager
2A	Clear 512 KB base RAM
2C	1-3-4-1 RAM failure on address line <b>xxx</b> *
2E	1-3-4-3 RAM failure on data bits <b>xxx</b> * of low byte of memory bus
2F	Enable cache before system BIOS shadow
32	Test CPU bus-clock frequency
33	Initialize Phoenix® Dispatch Manager

**Table A-1** BIOS Post Codes **(continued)**

<b>POST Code</b>	<b>Description</b>
36	Warm start shut down
38	Shadow system BIOS ROM
3A	Auto size cache
3C	Advanced configuration of chipset registers
3D	Load alternate registers with CMOS values
41	Initialize extended memory for RomPilot (optional)
42	Initialize interrupt vectors
45	POST device initialization
46	2-1-2-3 Check ROM copyright notice
48	Check video configuration against CMOS
49	Initialize PCI bus and devices
4A	Initialize all video adapters in system
4B	QuietBoot start (optional)
4C	Shadow video BIOS ROM
4E	Display BIOS copyright notice
4F	Initialize MultiBoot
50	Display CPU type and speed
51	Initialize EISA board (optional)
52	Test keyboard
54	Set key click if enabled
55	Enable USB devices
58	2-2-3-1 Test for unexpected interrupts
59	Initialize POST display service
5A	Display prompt "Press <ESC> to enter SETUP"

**Table A-1** BIOS Post Codes **(continued)**

<b>POST Code</b>	<b>Description</b>
5B	Disable CPU cache
5C	Test RAM between 512 and 640kB
60	Test extended memory
62	Test extended memory address lines
64	Jump to UserPatch1
66	Configure advanced cache registers
67	Initialize Multi Processor APIC
68	Enable external and CPU caches
69	Setup System Management Mode (SMM) area
6A	Display external L2 cache size
6B	Load custom defaults (optional)
6C	Display shadow-area message
70	Display error messages
72	Check for configuration errors
76	Check for keyboard errors
7C	Set up hardware interrupt vectors
7D	Initialize Intelligent System Monitoring (optional)
7E	Initialize coprocessor if present
80	Disable onboard Super I/O ports and IRQs (optional)
81	Late POST device initialization
82	Detect and install external RS232 ports
83	Configure non-MCD IDE controllers
84	Detect and install external parallel ports
85	Initialize PC-compatible PnP ISA devices



**Table A-1** BIOS Post Codes **(continued)**

<b>POST Code</b>	<b>Description</b>
86	Re-initialize onboard I/O ports.
87	Configure Motherboard Configurable Devices (optional)
88	Initialize BIOS Data Area
89	Enable Non-Maskable Interrupts (NMIs)
8A	Initialize Extended BIOS Data Area
8B	Test and initialize PS/2 mouse
8C	Initialize floppy controller
8F	Determine number of ATA drives (optional)
90	Initialize hard-disk controllers
91	Initialize local-bus hard-disk controllers
92	Jump to UserPatch2
93	Build MPTABLE for multi-processor boards
95	Install CD ROM for boot
96	Clear huge ES segment register
97	Fix up Multi-processor table
98	1-2 Search for option ROMs and shadow if successful. (One long, two short beeps on checksum failure)
99	Check for SMART Drive (optional)
9C	Set up Power Management
9D	Initialize security engine (optional)
9E	Enable hardware interrupts
9F	Determine number of ATA and SCSI drives
A0	Set time of day
A2	Check key lock

**Table A-1** BIOS Post Codes **(continued)**

<b>POST Code</b>	<b>Description</b>
A4	Initialize typematic rate
A8	Erase <ESC> prompt
AA	Scan for <ESC> key stroke
AC	Enter SETUP
AE	Clear Boot flag
B0	Check for errors
B1	Inform RomPilot about the end of POST (optional)
B2	POST done - prepare to boot operating system
B4	One short beep before boot
B5	Terminate QuietBoot (optional)
B6	Check password (optional)
B7	Initialize ACPI BIOS and PPM Structures
B9	Prepare Boot
BA	Initialize SMBIOS
BC	Clear parity checkers
BD	Display MultiBoot menu
BE	Clear screen (optional)
BF	Check virus and backup reminders
C0	Try to boot with INT 19
C1	Initialize POST Error Manager (PEM)
C2	Initialize error logging
C3	Initialize error display function
C4	Initialize system error flags
C6	Console redirection init.

**Table A-1** BIOS Post Codes **(continued)**

<b>POST Code</b>	<b>Description</b>
C7	Unhook INT 10h if console redirection enabled
C8	Force check (optional)
C9	Extended ROM checksum (optional)
CD	Reclaim console redirection vector
D2	Unknown interrupt
D4	Check Intel Branding string
D8	Alert Standard Format initialization
D9	Late init for IPMI
DE	Log error if micro-code not updated properly
<b>The following POST codes pertain to the boot block in Flash ROM</b>	
E0	Initialize the chipset
E1	Initialize the bridge
E2	Initialize the CPU
E3	Initialize system timer
E4	Initialize system I/O
E5	Check force recovery boot
E6	Checksum BIOS ROM
E7	Go to BIOS
E8	Set Huge Segment
E9	Initialize Multi Processor
EA	Initialize OEM special code
EB	Initialize PIC and DMA
EC	Initialize Memory type
ED	Initialize Memory size

**Table A-1** BIOS Post Codes **(continued)**

<b>POST Code</b>	<b>Description</b>
EE	Shadow Boot Block
EF	System memory test
F0	Initialize interrupt vectors
F1	Initialize Run Time Clock
F2	Initialize video
F3	Initialize System Management Manager
F4	Output one beep
F5	Clear Huge Segment
F6	Boot to Mini DOS
F7	Boot to Full DOS

If BIOS detects error 2C, 2E, or 30 (base 512K RAM error), it displays an additional word-bitmap (xxxx) indicating the address line or bits that failed. For example, “2C 0002” means address line 1 (bit one set) has failed. “2E 1020” means data bits 12 and 5 (bits 12 and 5 set) have failed in the lower 16 bits. The BIOS also sends the bitmap to the port-80 LED display. It first displays the checkpoint code, followed by a delay, the high-order byte, another delay, and then the low-order byte of the error. It repeats this sequence continuously.

## IPMI 2.0 Management Utility

This section describes the baseboard management controller (BMC) intelligent platform management interface (IPMI) 2.0 management utility. It provides basic overview information for the application that supports remote access (KVM-over-LAN).

IPMI defines the protocols used for interfacing with the BMC on the node board. The BMC links to a main processor and other onboard elements using a serial bus.

The BMC monitors onboard instrumentation such as temperature sensors, power status, voltages and fan speed, and provides remote power control capabilities to reboot and/or reset the server. It also includes remote access to the BIOS configuration and operating system console information via serial-over-LAN (SOL) or embedded KVM capabilities. Because the controller is a separate processor, the monitoring and control functions work regardless of CPU operation or system power-on status.

An administrator accesses the BMC by using an IPMI-compliant management application loaded on a PC or via a web interface on a management appliance that includes IPMI management and KVM. The IPMI protocol leverages an out-of-band network (typically dedicated for server monitoring and management), which provides a secure path for mission-critical applications when regular in-band connectivity is lost or is unresponsive. IPMI messages follow the same format whether they are received through an operating system or are sent and received out-of-band.

The BMC card supports the functionality of IPMI Version 2.0. The key features include the following:

- Supports IPMI 2.0
- Supports Serial over LAN
- Supports KVM over LAN
- Supports LAN Alerting-SNMP trap
- Supports Event Log
- Offers operating system (OS) independency
- Provides remote hardware health monitors.  
Key features include the following:
  - Temperature monitor
  - Fan speed monitor
  - Voltage monitor
  - Power status monitor
  - Chassis intrusion monitor
  - Remote power control to power-on, power-off or reboot a system
  - Remote access to text-based, graphic-based system information, including BIOS configurations and OS operation information (KVM)
  - Remote management of utility/software applications
- Provides Network Management Security via remote access/console redirection.  
Key features include:
  - User authentication enhancement
  - Encryption support enhancement, allowing for password configuration security to protect sensitive data transferring via Serial over LAN
- Supports the following management tools:
  - IPMIView
  - CLI (Command Line Interface)
- Supports RMCP & RMCP protocols

The following system administration functions are available through the BMC interface:

- “Remote Control” on page 150  
Click on this icon for remote access and management of video console redirection.
- “Virtual Media” on page 151  
Click on this icon to use virtual remote media devices.
- “System Health” on page 158  
Click on this icon to view and manage health monitoring for remote systems.
- “User Management” on page 164  
Click on this icon for User Management.
- “KVM Settings” on page 167  
Click on this icon to configure keyboard, Video and mouse settings.
- “Device Settings” on page 172  
Click on this icon to configure device settings.
- “Maintenance” on page 185  
Click on this icon to access, diagnose and manage hardware devices.

## Network Connection

1. Enter the IP address of the server in the address bar of your browser.
2. Once the connection is made, the Log In screen displays.
3. Enter the user name **admin** in the Username field.
4. Enter the password **admin** in the Password field and click on Login. The following menu is displayed:

---

**Note:** Click on the refresh button to refresh the remote console preview.

---

## Functions Listed on the Home Page

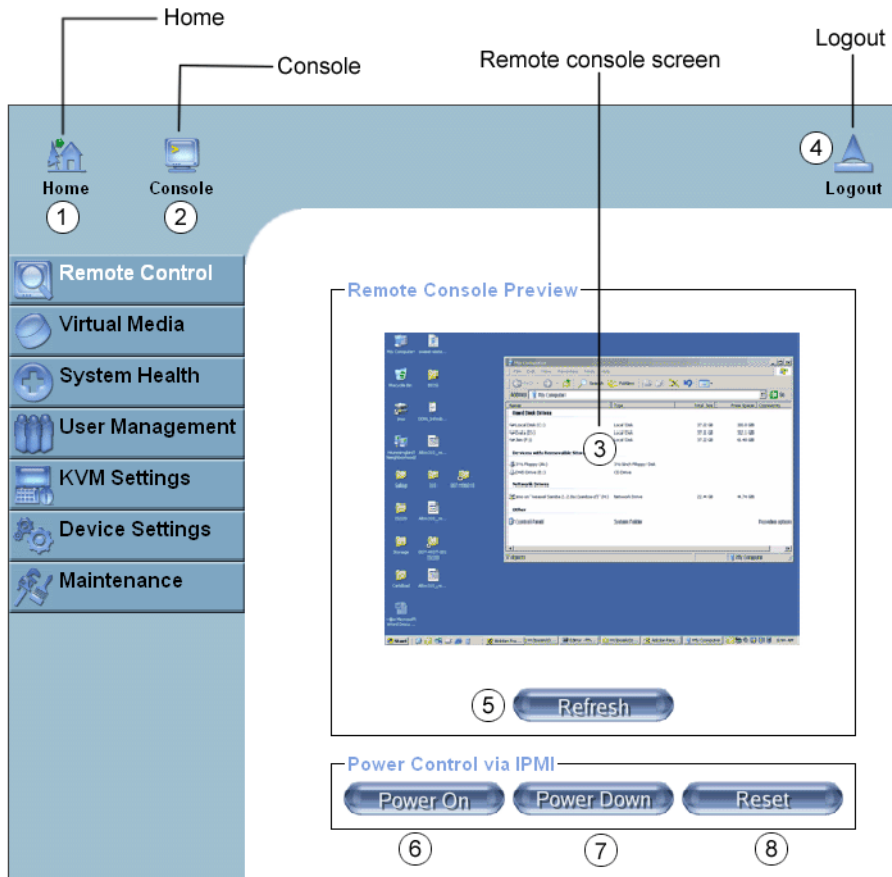

Figure B-1 BMC Remote Console



The functions of the icons for this home page are listed below:

- **Home:** Click this icon to return to the Home Page.
- **Console:** Click this icon to open the remote console screen.
- **Click to Open:** Click this link to open the remote console screen.
- **Logout:** Click this icon to log out.
- **Refresh:** Click this icon to refresh the remote console preview screen.
- **Power On:** Click this icon to power on the remote server.
- **Power down:** Click this icon to power down the remote server.
- **Reset:** Click this icon to reset the remote server.

## Remote Control

Click on the Remote Control icon (refer to Figure B-1) to activate its submenus, such as the KVM console and remote power functions.

## KVM Console

Click on this function to configure keyboard, mouse or video settings for the remote host.

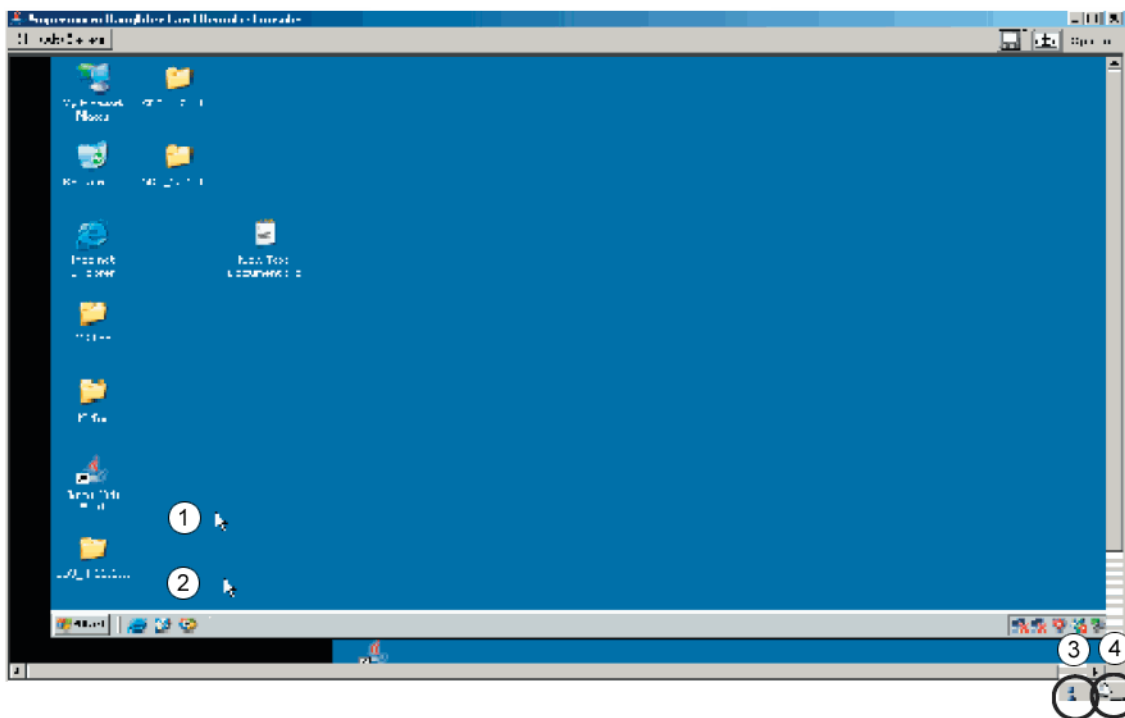

**Figure B-2** Remote Console Screen

Refer to Figure B-2.

1. In the Single/Synchronized Mouse Mode, this cursor indicates the system that is currently active. For the Double Mouse mode, this is the cursor for the remote host.
2. This second mouse cursor only appears in the Double Mouse Mode. This cursor represents the local mouse.
3. This icon indicates the availability of Keyboard and Mouse.
4. This icon indicates the number of networks (users) that are connected via Console Redirection. (The number of figure icons indicates the number of users connected.)

## Remote Power

Click on this item to configure the power settings for Remote Console.

- **Power On:** Click on this icon to power on the remote host.
- **Power Down:** Click on this icon to power down the remote host.
- **Reset:** Click on this icon to reset the remote host.

## Virtual Media

Click on the Virtual Media icon on the Home Page to activate its submenus-Floppy Disk, CD-ROM, Drive Redirection and Options.

---

**Note:** The floppy disk menu is not used in the SGI Altix XE310 system. The BIOS file size exceeds that of a floppy disk image.

---

## CD-ROM Image

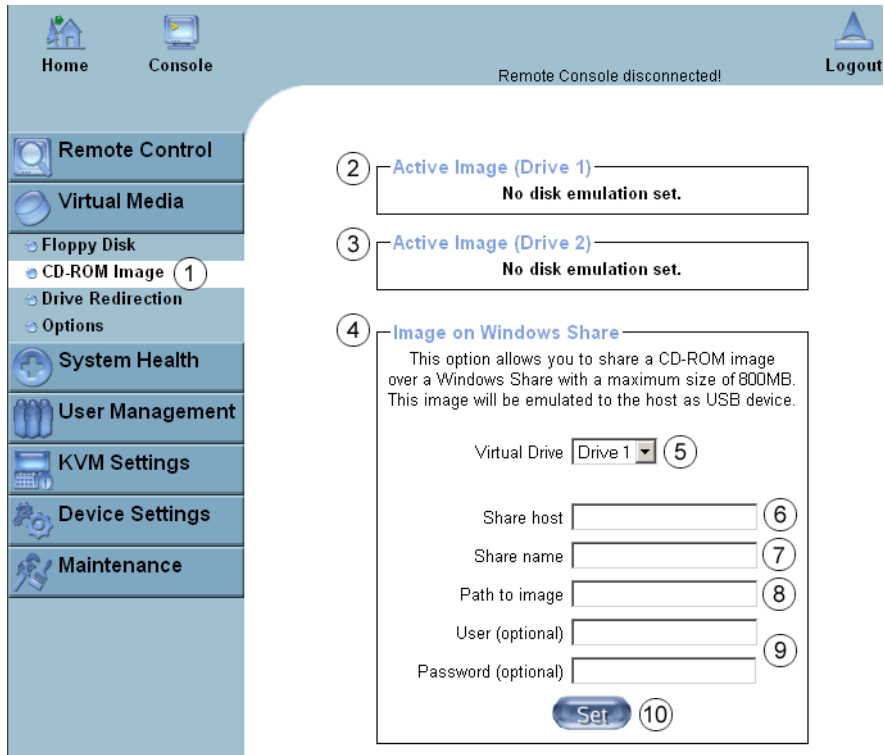

Figure B-3 CD-ROM Image

Refer to Figure B-3.

1. **CD-ROM image:** Click on this function key to share data stored in your local CD-ROM drive with other users in the remote host through the Windows Share application via USB.
2. **Active Image (Drive1):** This window displays the filename of the data currently active in host Drive 1.
3. **Active Image (Drive2):** This window displays the filename of the data currently active in host Drive 2.
4. **Image on Windows Share:** This option enables you to configure Windows Share settings. It enables you to decide how you want to share the data stored in your local CD-ROM with users in the remote host.
5. **Virtual Drive:** Specify the drive that you want to share your data with in the remote host.
6. **Share Host:** Enter the IP Address or the name of the system you wish to share data with via Windows Share.
7. **Share Name:** Enter the name of the system you wish to share data with in the remote host.
8. **Path to Image:** Enter the location of source files that you wish to share via Windows Share.
9. **User/Password (Optional):** Enter the Username and password for the person to access the data that you want to share and
10. Click “Set” to enter your selections.

## Drive Redirection

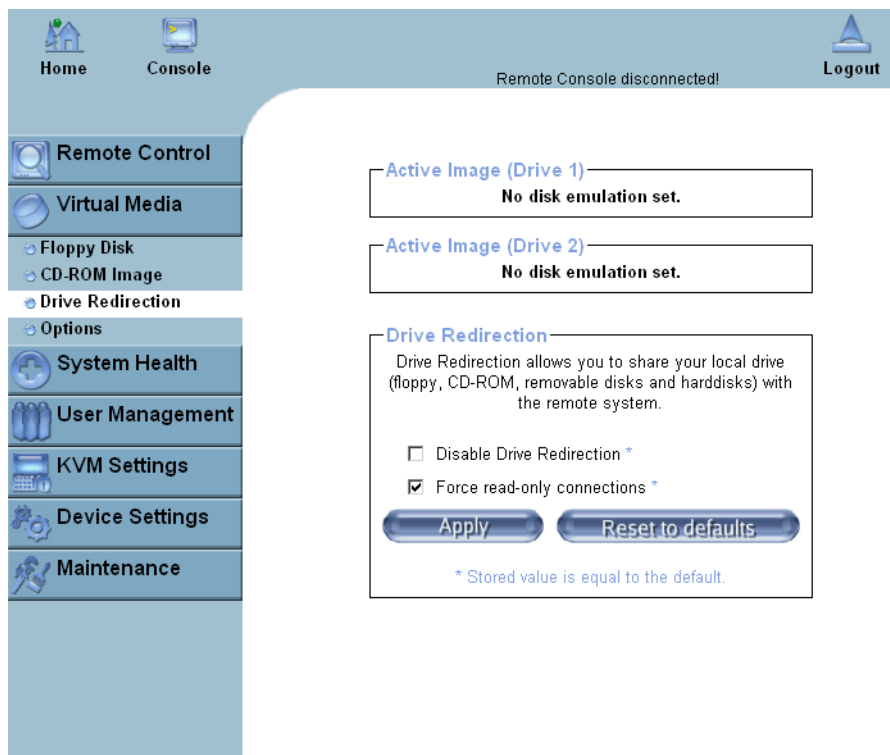
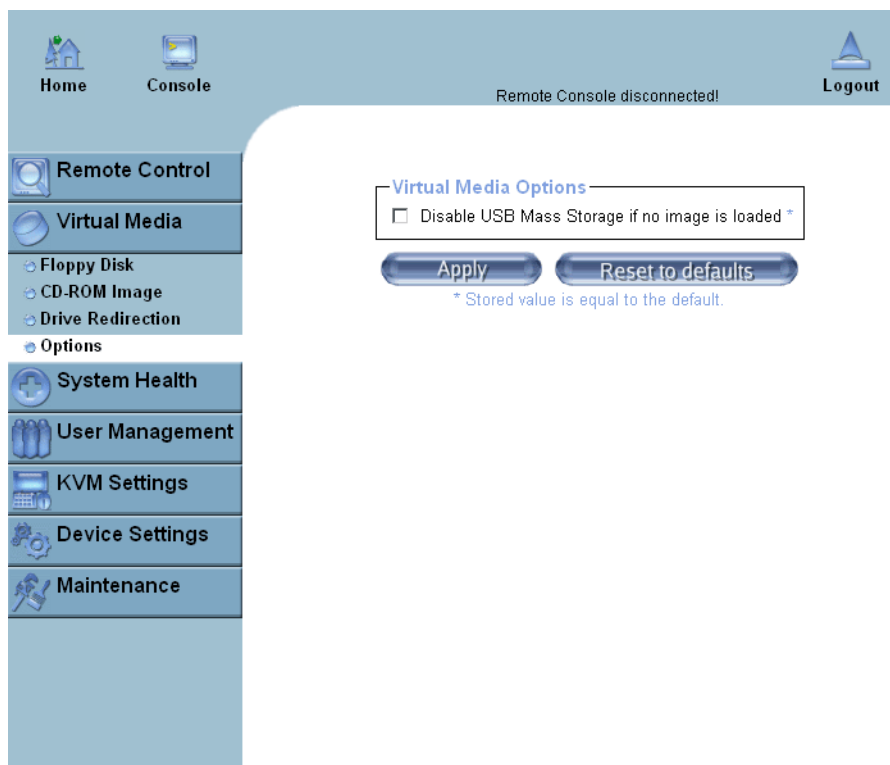

Figure B-4 Drive Redirection

Refer to Figure B-4.

- **Drive Redirection:** Click on this function key to make local drives accessible for other users via console redirection. This function enables you to share your local drives (CD-ROM and HDDs) with users in the remote systems.
- **Active Image (Drive1):** This window displays the filename of the data currently active in host Drive 1.
- **Active Image (Drive2):** This window displays the filename of the data currently active in host Drive 2.
- **Disable Drive Redirection:** Check the box to disable Drive Redirection. Once this function is disabled, local drives are not be accessible for other users in remote host.
- **Force Read Only:** Check this box to allow the data stored in local drives to be read in a remote system, but it cannot be overwritten to ensure data integrity and system security.
- **Apply:** Once you've configured your settings, click “Apply” to enter your settings.
- **Reset Default:** You can also enter your own setting values and re-set these values as “default” by clicking on this icon to reset the defaults.

## Virtual Media Options



**Figure B-5** Virtual Media Options



Refer to Figure B-5.

- **Options:** Click on this item to activate the Virtual Media sub-menu.
- **Virtual Media Options:** Use this option to disable or enable USB mass storage in the remote host. Check this box to disable the function of Virtual Media Options to prevent data stored in a local drive from being accessed, or uploaded by the user in the remote host. The default setting is “Enabled.”
- **Apply:** Once you have checked the box, click “Apply” to enter this value.
- **Reset to Defaults:** Click on this icon if you want to set “Disabled” as the default setting for the Virtual Media Options.

## System Health

Click on the System Health icon on the Home Page to activate its submenus: Chassis Control, Monitor Sensor, System Event Log and Alert settings.

## Chassis Control

Click on this item to access Health Monitoring information on the remote system.

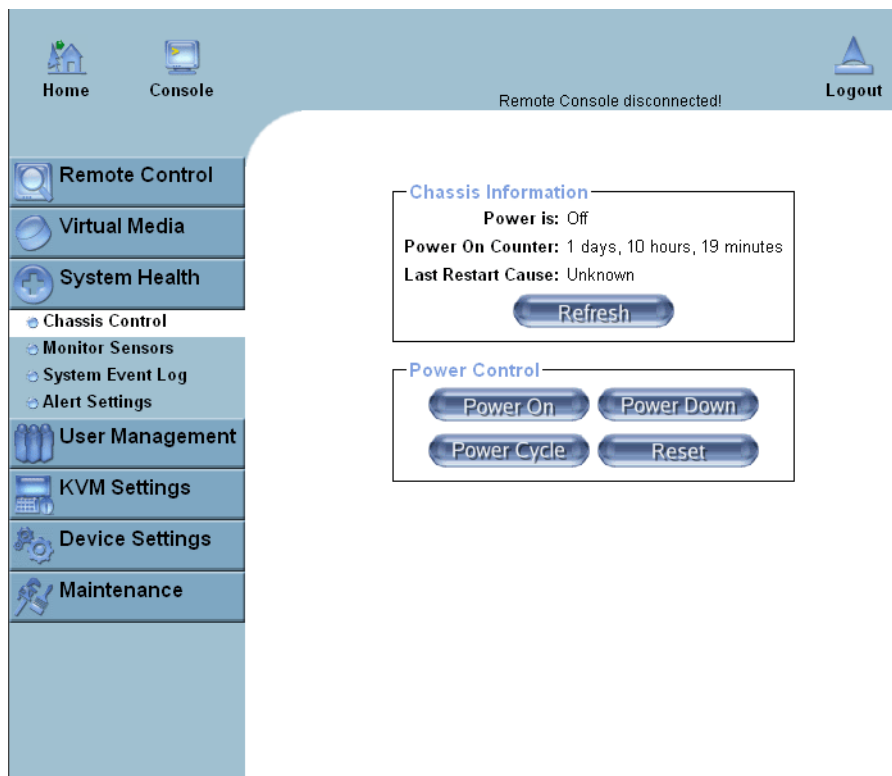

**Figure B-6** Chassis Control

Refer to Figure B-6.

- **Power Is:** This indicates if the system is on or off for the remote host.
- **Power On Counter:** If power is on, then the counter indicates the length of time the power has been turned on.
- **Last Restart Cause:** This item states the reason why the host system is restarted if the system has been turned off.
- **Refresh:** Click the Refresh button to update “Chassis Information” as shown in Window 2.
- **Refresh:** Click on this icon to refresh the screen of the remote host.
- **Power On:** Click on this icon to power on the system for the remote host.
- **Power Down:** Click on this icon to power down the system for the remote host.
- **Reset:** Click on this icon to reset the remote console.
- **Power Cycle:** Click on this icon to power down the system for the remote host and turn it back on later.

## Monitor Sensors

Click on this item to display the Health Monitoring Information shown in Figure B-7 and Table B-1.

Home Console Remote Console disconnected! Logout

Remote Control  
Virtual Media  
System Health  
Chassis Control  
Monitor Sensors  
System Event Log  
Alert Settings  
User Management  
KVM Settings  
Device Settings  
Maintenance

**Monitoring Sensors**

Sensor Type	Sensor Name	Sensor Status	Sensor Reading
Temperature	CPU1 Temp A	No reading	
Temperature	CPU2 Temp A	No reading	
Temperature	CPU1 Temp B	No reading	
Temperature	CPU2 Temp B	No reading	
Temperature	Sys Temp	No reading	
Voltage	CPU1 Vcore	No reading	
Voltage	CPU2 Vcore	No reading	
Voltage	3.3V	No reading	
Voltage	5V	No reading	
Voltage	12V	No reading	
Voltage	-12V	No reading	
Voltage	1.5V	No reading	
Voltage	5VSB	No reading	
Voltage	VBAT	No reading	
Fan	Fan1/CPU1	No reading	
Fan	Fan2/CPU2	No reading	
Fan	Fan3	No reading	
Fan	Fan4	No reading	
Fan	Fan5	No reading	
Fan	Fan6	No reading	
Fan	Fan7	No reading	
Fan	Fan8	No reading	
Physical Security	Intrusion	No reading	
Power Supply	Power Fail	OK	
Processor	CPU0 Internal E	OK	
Processor	CPU1 Internal E	OK	
Module / Board	CPU Overheat	Limit Exceeded	
Processor	Thermal Trip0	OK	
Processor	Thermal Trip1	OK	

Refresh

Figure B-7 Monitor Sensors

**Table B-1** Health Monitoring Sensors

<b>Temperature Monitoring</b>	CPU1 Temperature (Temp A, Temp B)	Temp A: CPU1 Core1 Temperature Temp B: CPU1 Core2 Temperature
	CPU2 Temperature (Temp A, Temp B)	Temp A: CPU2 Core1 Temperature Temp B: CPU2 Core2 Temperature
	System Temperature	
<b>Voltage Monitoring</b>	CPU1 VCore	CPU1 Vcore: CPU1 Core Voltage
	CPU2 VCore	CPU2 Vcore: CPU2 Core Voltage
	3.3V	
	5V, 5VSB	5VSB: 5V Standby
	+12V, -12V	
	1.5V	
	VBAT	VBAT: Battery voltage
<b>Fan Control</b>	Fan1/CPU Fan	
	Fan2/CPU Fan	
	Fan 3 – Fan 6	
<b>Physical Security</b>	Chassis Intrusion	
<b>Node Board CPU0 Internal Err</b>		
<b>Node Board CPU1 Internal Err</b>		
<b>Node Board CPU Overheat</b>		When the CPU temperature exceeds this preset temperature, the overheat LED or alert is triggered, the CPUs slow down, the CPU fans are in the full speed mode.
<b>Node Board Thermal Trip</b>		When the system temperature exceeds this preset temperature, the overheat LED or alert is triggered, and the cooling fans are in the full speed mode to prevent system overheat.

## System Event Log

Click on this item to display the System Health Event Log for the remote system.

Home Console Remote Console disconnected! Logou

Remote Control

Virtual Media

System Health

- Chassis Control
- Monitor Sensors
- System Event Log
- Alert Settings

User Management

KVM Settings

Device Settings

Maintenance

System Event Log						
Event Type	Date	Time	Source	Description	Direction	
SEL record 02	Pre-Init	00:54:33	CPU Overheat	Limit Exceeded	Assertion Event	
SEL record 02	Pre-Init	00:53:29	CPU Overheat	Limit Exceeded	Assertion Event	
SEL record 02	Pre-Init	00:53:29	CPU1 Internal E	IERR	Deassertion Event	
SEL record 02	Pre-Init	00:53:29	CPU0 Internal E	IERR	Deassertion Event	
SEL record 02	Pre-Init	00:53:21	CPU1 Internal E	IERR	Assertion Event	
SEL record 02	Pre-Init	00:53:21	CPU0 Internal E	IERR	Assertion Event	

Figure B-8 System Event Log

## Alert Settings

Click on this item to activate the alert settings submenu for the remote system.

IPMI Alert Configuration

[ Filter List ] [ Policy List ] [ LAN Destination List ]

IPMI Filter List

Index	Status	Filter Type	Action	Policy#	Severity	Generator ID	Sensor Type	Sensor No	Trigger	Offset Mask	Data 1	Data 2	Data 3	
1	disabled	configurable		0	unspecified	00 00	00 00	00 00	00	0000	00 00	00 00	00 00	[edit]
2	disabled	configurable		0	unspecified	00 00	00 00	00 00	00	0000	00 00	00 00	00 00	[edit]
3	disabled	configurable		0	unspecified	00 00	00 00	00 00	00	0000	00 00	00 00	00 00	[edit]
4	disabled	configurable		0	unspecified	00 00	00 00	00 00	00	0000	00 00	00 00	00 00	[edit]
5	disabled	configurable		0	unspecified	00 00	00 00	00 00	00	0000	00 00	00 00	00 00	[edit]
6	disabled	configurable		0	unspecified	00 00	00 00	00 00	00	0000	00 00	00 00	00 00	[edit]
7	disabled	configurable		0	unspecified	00 00	00 00	00 00	00	0000	00 00	00 00	00 00	[edit]
8	disabled	configurable		0	unspecified	00 00	00 00	00 00	00	0000	00 00	00 00	00 00	[edit]
9	disabled	configurable		0	unspecified	00 00	00 00	00 00	00	0000	00 00	00 00	00 00	[edit]
10	disabled	configurable		0	unspecified	00 00	00 00	00 00	00	0000	00 00	00 00	00 00	[edit]
11	disabled	configurable		0	unspecified	00 00	00 00	00 00	00	0000	00 00	00 00	00 00	[edit]
12	disabled	configurable		0	unspecified	00 00	00 00	00 00	00	0000	00 00	00 00	00 00	[edit]
13	disabled	configurable		0	unspecified	00 00	00 00	00 00	00	0000	00 00	00 00	00 00	[edit]
14	disabled	configurable		0	unspecified	00 00	00 00	00 00	00	0000	00 00	00 00	00 00	[edit]
15	disabled	configurable		0	unspecified	00 00	00 00	00 00	00	0000	00 00	00 00	00 00	[edit]
16	disabled	configurable		0	unspecified	00 00	00 00	00 00	00	0000	00 00	00 00	00 00	[edit]

Figure B-9 Alert Settings

## User Management

Click on the User Management icon on the Home Page to activate its submenus:

### Change Password

Change Password, Users & Group and Permissions as needed. Click on this icon to activate the Passwords submenu.

1. **Change Password.** Click on this icon to access the New Password and Confirm New Password fields.
2. **New Password:** Enter your new password in the blank.
3. **Confirm New Password:** Enter your new password in the blank again and click “Apply” to confirm it.



## Users and Groups

Click on this icon to activate the Users & Groups submenu.

- **User Management:** This window displays the user's information.
- **Existing users:** Select an existing user for information updates. Once a user is selected, click on the "Lookup" icon on right to view user information.
- **New user name:** Enter new user name in this field.
- **Full user name:** Enter full user name in this field.
- **Password and Confirm Password:** Type the user's password in the field and then type the password again in the next field to confirm it. The password must be 4 characters or longer.
- **Email Address:** Enter the user's email address in the field. (Optional)
- **Mobile Phone:** Enter the user's mobile phone number in the field. (Optional)
- **Group Membership:** This field indicates the group that the user belongs to. To select a group, click on the group name on the "Not Member Of" window to select it, then click on the backwards arrow to enter the group name in the Group Membership field. Reverse the procedure to remove the user from a group.
- **IPMI Privilege Level:** Click on the arrow key on the right to activate the Privilege Selection menu. The IPMI Privilege Level contains five categories: No Access, User, Operator, Administrator and OEM.
- **Create:** Click on this button to enter a new user's or group information in the User/Group Management fields.
- **Modify:** Click on this button to modify a user's or group information in the User/ Group Management fields.

## Permissions

Click on this icon to activate the User/Group Permissions submenu.

- **Show Permissions for User/Group:** Click on the arrow on the right to activate the user/group permissions selection menu.
- **Update:** Click this icon to update permissions information.
- **Effective Permissions:** This field indicates the actual permissions assigned to a user/group.
- **User Permissions:** This field indicates the actual permissions assigned to a user.
- **Inherited Group Permission:** This field indicates the permissions a user has due to the fact that he or she belongs to a certain group.
- **Copy:** Click on this button to copy a user's or group information in the User/Group Management fields.
  - **Copy User:** Choose an Existing User from the selection box. Enter a new user name in the field "New User Name." Click on the "Copy" button and a new user with the name you have entered is created. The properties of the selected user are copied to the new user.
  - **Copy Group:** Choose an Existing group from the selection box. Enter a new group name in the field "New Group Name." Click on the "Copy" button and a new group with the name you have entered is created. The properties of the selected group are copied to the new group.
- **Delete:** Click on this button to delete a user's or group information in the User/Group Management fields.
- **Group Management:** This window enables you to enter group information for better user management.

## KVM Settings

Click on the KVM Settings icon on the Home Page to activate its submenus:

### User Console

Refer to Figure B-10.

- **User Console:** Click on this icon to activate the User Console submenu.
- **User Selection:** This field enables you to decide which group the user belongs to. Click on the arrow on the right to activate the selection menu and highlight the name of the group to select it.
- **Update:** Once you have selected the group name, click on Update to save the selections.
- **Transmission Encoding:** This field enables you to decide how (the video) data is transmitted between the local system and the remote host.
- **Automatic Detection:** Select this option to allow the OS to automatically detect the networking configuration settings such as the bandwidth of the connection line, and transmit data accordingly.
- **Pre-configured:** This item enables you to select the data transmission setting from a predefined options list. The pre-configured settings provide the best result because the compression and color depth settings are adjusted for optimization based on the network speed indicated.
- **Network speed:** Once you have selected the pre-configured option above, you then can select a desired network speed setting from the selection menu by clicking on the arrow on the right.
- **Manually:** You can select a desired network speed setting from the selection menu by clicking on the arrow on the right. This item enables you to adjust both compression and color depth settings individually.
- **Compression:** Data signal transmission is compressed to save bandwidth. High compression rates slow down network interfacing and should not be used when several users are connected to the network.

Home
Console
Logout

- Remote Control
- Virtual Media
- System Health
- User Management
- KVM Settings
- User Console
- Keyboard/Mouse
- Device Settings
- Maintenance

**General Settings**

Disable Remote Console Access \*

**Remote Console Settings for User**

The settings on this page are user specific. Changes you make here will affect the selected user only.

ADMIN

**Transmission Encoding**

Automatic Detection \*

Pre-configured

Network speed LAN (high color) \*

Manually

Compression 0 - none \*

Color depth 16 bit - high col \*

**Remote Console Type**

Default Java VM \*

Sun Microsystems Java Browser Plugin

If you do not have the Java Browser Plugin already installed on your system, this option will cause downloading of around 11 MByte Plugin code. The Plugin will enable extended Remote Console functionality.

**Miscellaneous Remote Console Settings**

Start in Monitor Mode \*

Start in Exclusive Access Mode \*

**Mouse Hotkey**

Hotkey Alt+F12 \*

Used for fast mouse synchronization (in Double Mouse mode) and to free the grabbed mouse (in Single Mouse mode).

[Click here for Help](#)

**Remote Console Button Keys**

Key Definition	Name
confirm Ctrl+Alt+Delete	
Key 1	

[Click here for Help](#)

\* Stored value is equal to the default.

**Figure B-10** User Console Settings

- 
- **Color Depth:** Click on the arrow on the right to select either 16 bit-high colors or 8 bit-256 colors. The standard color depth is 16 bit-high color. This setting is recommended for compression level 0. For typical desktop interfaces, the setting of 8 bit-256 colors is recommended for faster data transmission.
  - **Remote Console Type:** This field enables you to decide which Remote Console Viewer to use.
  - **Default Java VM (JVM):** Select this option to use the default Java Virtual Machine (JVM) of your web browser. This can be the Microsoft JVM for Internet Explorer or the Sun JVM depending on the configuration of your browser.
  - **Sun Microsystems Java Browser Plugin:** Select this option when the JVM used to run the code for the Remote Console is a Java applet. If you use this function for the first time and the appropriate Java plugin is not yet installed in your system, you may download and install it automatically. To download and install it, you need to check “yes” in the dialogs.

---

**Note:** If your internet connection is slow, please pre-install the JVM on your administration machine.

---

- **Miscellaneous Remote Console Settings:** This window enables you to specify the following Remote Console Settings.
- **Start in Monitor Mode:** Check this box to enable the Start in Monitor Mode which enable data to be displayed in the remote monitor as soon as Remote Console is activated. (The data displayed in the remote monitor is read-only.)
- **Start in Exclusive Access Mode:** Check this box to enable the exclusive access mode immediately at Remote Console startup which forces all other users connected to the network to close their connection. No other users can open the Remote Console until you disable this function or log off.
- **Mouse Hotkey:** This option enables you to use a hotkey combination to specify the mouse synchronization mode or the single mouse mode.
- **Hotkey:** Enter a hotkey combination in the box to specify the mouse synchronization mode or the single mouse mode.
- **Remote Console Button Keys:** This window enables you to define button keys for the remote host. The button keys allow simulating keystrokes on a remote host or issuing commands to a remote system. The button keys are needed when you have a missing key or when you want to prevent interference caused to the local system. After a remote console button key is set, it displays on the right upper corner of the remote monitor screen.
- **Button Keys:** Enter the syntax of a button enter the box.

- **Name:** Enter the name of a button enter the box.
- **More Entries:** Click on this icon to create more Button Keys.

## Keyboard/Mouse

Select Keyboard/Mouse to configure the keyboard and mouse settings:

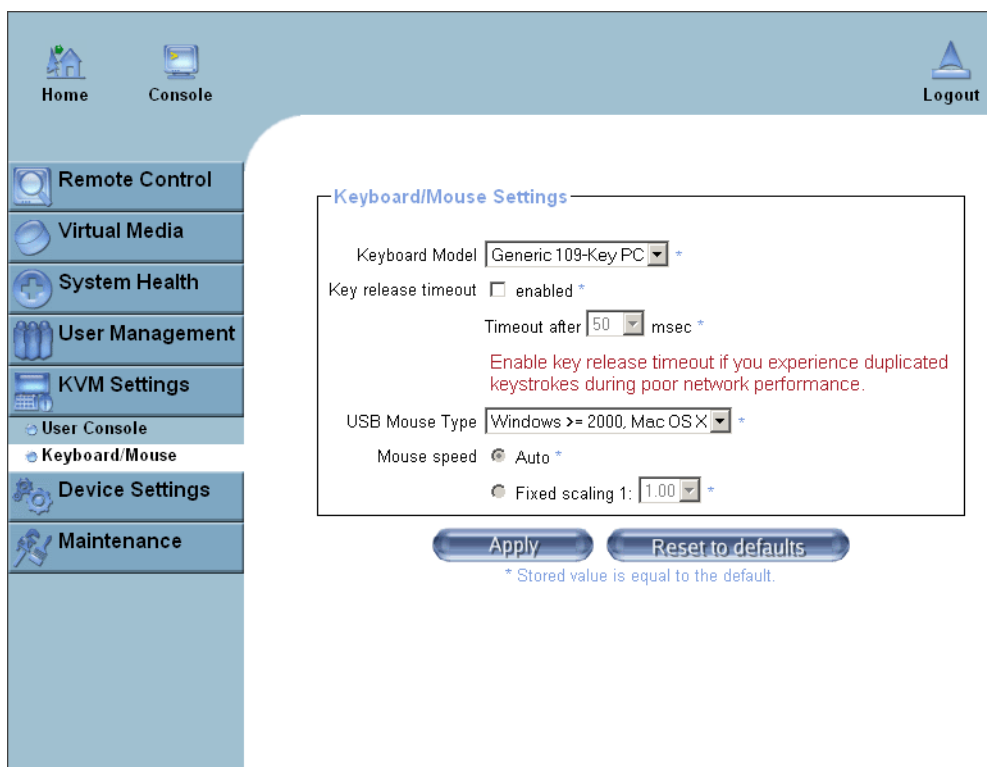

Figure B-11 Keyboard/Mouse Settings

Refer to Figure B-11.

- **Keyboard Model:** Select your keyboard model from the pull-down menu.
- **Key Release Timeout:** Check this box to enable the function of “Key Release Timeout,” which sets the time limit for a key to be pressed by the user.
- **Timeout after \_\_\_\_\_ msec:** If the “Key Release Timeout” indicated above has been enabled, click on the arrow on the right to activate a selection menu to select the timeout setting for the item above.
- **USB Mouse Type:** For the USB Mouse to function properly, please select the correct OS for your system from the selection menu by clicking on the arrow on the right.
- **Mouse Speed-Auto:** Check the selection to allow your system to automatically set your mouse speed.
- **Fixed Scaling:** You can also check the “Fixed Scaling” box and manually enter your selection.
- **Apply:** Click on this icon to enter your selections.
- **Reset to defaults:** Cancels your selections and uses the default values set by the manufacturer.

## Device Settings

Click on the Device Settings icon on the Home Page to activate its the device settings menu.

### Network

Click on this function key to activate the Network submenu to configure the network settings.

Home Console Logout

Remote Control  
Virtual Media  
System Health  
User Management  
KVM Settings  
Device Settings

Network  
Dynamic DNS  
Security  
Certificate  
Date/Time  
Event Log  
SNMP Settings  
Maintenance

#### Network Basic Settings

IP auto configuration  \*

Preferred host name (DHCP only)  \*

IP address

Subnet mask  \*

Gateway IP address

Primary DNS server IP address  \*

Secondary DNS server IP address  \*

#### Network Miscellaneous Settings

Remote Console & HTTPS port  \*

HTTP port  \*

SSH port  \*

Bandwidth Limit  kbit/s \*

Enable SSH access

Disable Setup Protocol \*

#### LAN Interface Settings

Current LAN interface parameters: autonegotiation on, 100 Mbps, full duplex, link ok

LAN interface speed  \*

LAN interface duplex mode  \*

\* Stored value is equal to the default.

Figure B-12 Network Settings



Refer to Figure B-12.

- **IP Auto Configuration:** Click on the box to activate the selection menu and select a desired item from the list. The options are None, DHCP, and BOODP.
- **Preferred Host Name (DHCP only):** Enter a Preferred Host Name in the box.
- **IP Address:** Enter the IP Address for the remote host in the box.
- **Subnet Mask:** Enter the net mask of the local network in the box.
- **Gateway IP Address:** Enter the local network router's IP address in this box for the accessibility of the users that are not connected to the local network.
- **Primary DNS Server IP Address:** Enter the IP Address of the Primary Domain Name Server in the box.
- **Secondary DNS Server IP Address:** Enter the IP Address of the Secondary Domain Name Server in the box. It is used when the Primary DNS Server cannot be contacted.
- **Network Miscellaneous Setting:** This field enables you to configure the following Network Miscellaneous settings as listed below:
- **Remote Console & HTTPS Port:** Enter the port numbers the remote host and the HTTP server are listening. If a number is not entered in the box, the default value is used.
- **HTTP Port:** Enter the port number the HTTP server is listening. If a number is not entered in the box, the default value is used.
- **SSH Port:** Enter the port number the SSH server is listening. If a number is not entered in the box, the default value is used.
- **Bandwidth Limit:** Enter the maximum bandwidth value for network interfacing. The value should be in Kbits per second.
- **Enable SSH Access:** Click this box to enable SSH Access.
- **Disable Setup Protocol:** Check this box to disable the function of Setup Protocol for the BMC card.
- **LAN Interface Setting:** This field enables you to configure the following LAN Interface settings as listed below:
- **LAN Interface Speed:** Click on the arrow on the right to activate the selection menu and select a desired speed. The options are: Auto-detect, 10 Mega bits per second or 100 Mega bits per second. If Auto-detect is selected, LAN Interface Speed is set at the optimized speed based on the system configurations detected by the OS.

- **LAN Interface Duplex Mode:** Click on the arrow on the right to activate the selection menu to select a desired LAN Interface Duplex Mode. The options are: Auto-detect, Half Duplex and Full Duplex. If Auto-detect is selected, the LAN Interface Duplex Mode is set to the optimized setting based on the system configurations detected by the OS.

## Dynamic DNS

Click on this function key to activate its submenu and configure the Dynamic Domain Name Server (DNS).

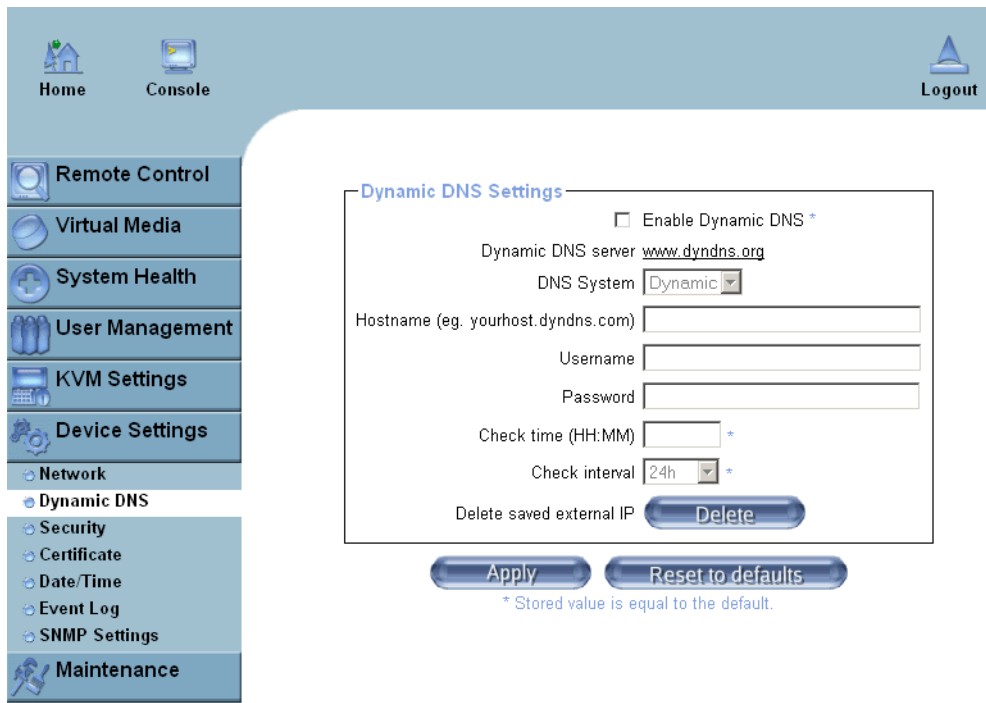

Figure B-13 Dynamic DNS Settings

Refer to Figure B-13.

- **Enable Dynamic DNS:** Check this box to enable the Dynamic DNS service.
- **Dynamic DNS Server [www.dyndns.org](http://www.dyndns.org):** Click this link to access the DynDNS web site. This is the server name where the DDNS Service is registered.
- **DNS System:** When Dynamic DNS is enabled, you can select from the options: Custom or Dynamic from the selection menu. Select “Custom” to use your own system as the DNS server. Select Dynamic to use the pre-configured Dynamic DNS as your server.
- **Hostname:** Enter the name you want to use for the remote host server.
- **Username/Password:** Enter the username and the password for the remote host user.
- **Check time (HH:MM):** Enter the time the BMC card first registers with the DNS server in the HH:MM Format. (e.g. 07:25, 19:30).
- **Check Interval:** Enter the interval for the IPMI to report to the Dynamic DNS again.
- **Delete Saved External IP Address:** Click on the Delete Icon to delete the IP Address for an external system that has been previous entered and saved.

## Security

Click on this function key to activate the Security settings.

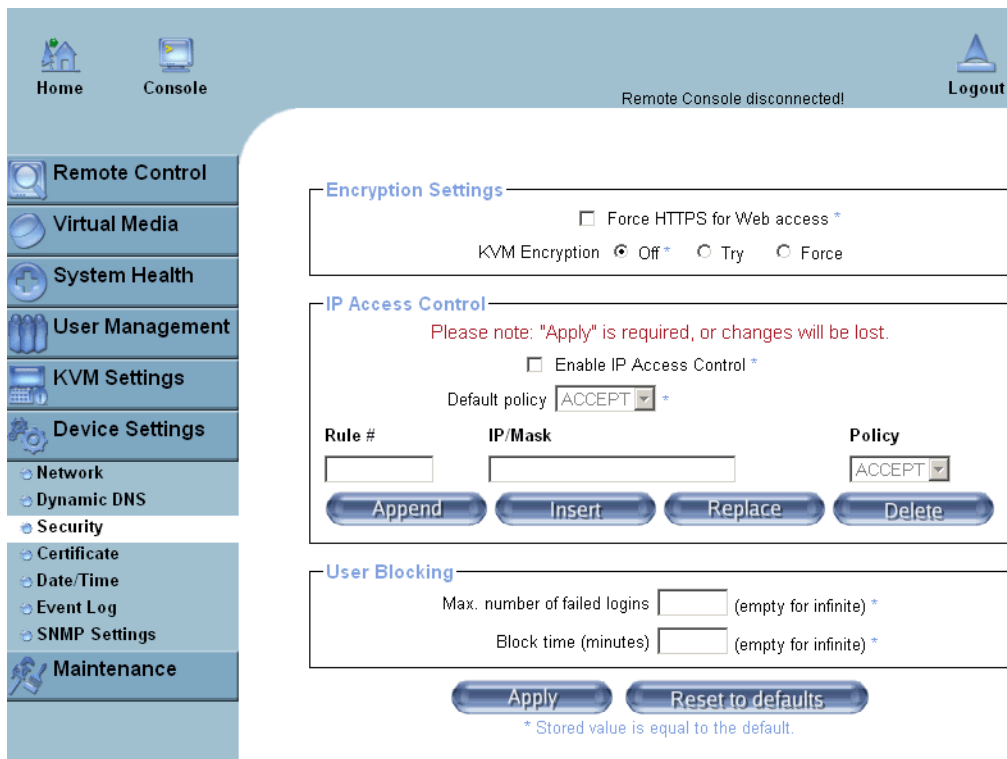

**Figure B-14** Security Settings

Refer to Figure B-14:

- **Encryption Settings:** This window enables you to configure encryption settings.
- **Force HTTPS for Web Access:** Check this box to enable the function-Force HTTPS for Web Access. If enabled, you must to use an HTTPS connection to access to the web.
- **KVM Encryption:** This option enables you to configure the encryption of the RFB protocol. RFB is used by the remote host to transmit video data displayed in the host monitor to the local administrator machine, and transmit keyboard and mouse data from the local administrator machine back to the remote host. If set to “Off,” no encryption is used. If set to “Try,” the applet (JVM of the remote host) attempts to make an encrypted connection. In this case, when a connection cannot be established, an unencrypted connection is used. If set to “Force,” the applet makes an encrypted connection. In this case, an error is reported if no connection is made.

- **IP Access Control:** This section enables you to configure the IP Access Control settings listed below.
- **Enable IP Access Control:** Check this box to enable the function of IP Access Control. This function is used to limit user access to the network by identifying them by their IP addresses. (This function is available to the LAN interface only.)
- **Default Policy:** When **IP Access Control** set to “enabled,” you can select either “accept” or “drop”, allowing access or denying access according to pre-defined rules.
- If this option is set to “drop,” and you do not have a set of rules to accept the internet connection, then the internet connection over LAN is impossible. In this case, you need to change your security settings via modem or by disabling the **IP Access Control**.
- **Rule#:** Enter a rule number in the box for a command (or commands) that is used by the IP Access Control.
- **IP/Mask:** Enter the IP Address or an IP Address Range for which the command(s) are applied.
- **Policy:** This item instructs the IPMI what to do with the matching packages.

---

**Note:** The sequence or the order of the rules is important. The rules are checked in the ascending order until a rule matches. All rules below the matching rule are ignored. The default policy applies if no matching rules are found.

---

- **Append:** Select this option to add IP Address/Mask, rules or commands to the existing ones.
- **Insert:** Select this option to insert IP Address/Mask, rules or commands to the existing ones.
- **Replace:** Select this option to replace an old IP Address/Mask, rule or command with a new one.
- **Delete:** Select this option to delete (a part of) an existing IP Address/Mask, rule or command.
- **User Blocking:** This window enables you to set the conditions how a user is blocked.
- **Max. Number of Failed Logins:** Enter the maximum number of failed attempts or failed logins allowed for a user. If the number of failed logins or attempts exceeds this maximum number allowed, the user is blocked from system.

---

**Note:** If this box is left empty, the user is allowed to try to login to the server indefinitely. For network security, this is not recommended.

---

- **Block Time (Minutes):** Enter the number of minutes allowed for a user to attempt to login. If the user fails to login within this time allowed, the user is blocked from system.

**Note:** If this box is left empty, the user is allowed to try to login to the server infinitely. For network security, this is not recommended.

## Certificate

Click on this function key to activate its submenu and configure the Certificate settings.

The screenshot shows the IPMI 2.0 Management Utility interface. At the top, there are icons for Home, Console, and Logout, along with the status "Remote Console disconnected!". The left sidebar contains a list of navigation options: Remote Control, Virtual Media, System Health, User Management, KVM Settings, Device Settings, Network, Dynamic DNS, Security, Certificate (highlighted), Date/Time, Event Log, SNMP Settings, and Maintenance. The main content area displays the "Certificate Signing Request (CSR)" form. The form includes the following fields: Common name, Organizational unit, Organization, Locality/City, State/Province, Country (ISO code), Email, Challenge password, and Confirm Challenge password. A dropdown menu for "Key length (bits)" is set to "1024". Below the form are two buttons: "Create" and "Reset to defaults". A note at the bottom of the form states: "\* Stored value is equal to the default."

Figure B-15 Certificate Settings

Refer to Figure B-15

- **Certificate Signing Request (CSR):** This window enables you to define the Certificate Signing Request (CSR) form. The IPMI uses the Secure Socket Layer (SSL) protocol for encrypted network traffic between itself and the remote host servers. When a connection is made, the IPMI has to expose its identity to a remote host by using a cryptographic certificate.

To create a certificate that is unique to a particular IPMI card or BMC card, a certification authority (CA) must fill out the CSR form indicated in the CSR window above and click “Create” to generate it.

- **Common Name:** Enter the (fully qualified domain) network name of the IPMI.
- **Organization Unit:** Enter the name of the department within an organization that the IPMI belongs to.
- **Organization:** Enter the name of the organization that the IPMI belongs to.
- **Locality/City:** Enter the name of the city or the location where the organization is located.
- **State/Province:** Enter the name of the state/province where the organization is located.
- **Country (ISO):** Enter the name of the country or the ISO code where the organization is located.
- **Email:** Enter the email address of a contact person that is responsible for the IPMI.
- **Challenge Password:** Enter a challenge Password for the Certification Authority to authorize necessary changes to the certificate at a later time. The password shall be four characters or longer.
- **Confirm Challenge Password:** Enter a challenge Password one more time to confirm it.
- **Key Length (bits):** This is the length of key generated in bits.

## Date and Time

Click on this function key to activate the internal realtime clock for your BMC card.

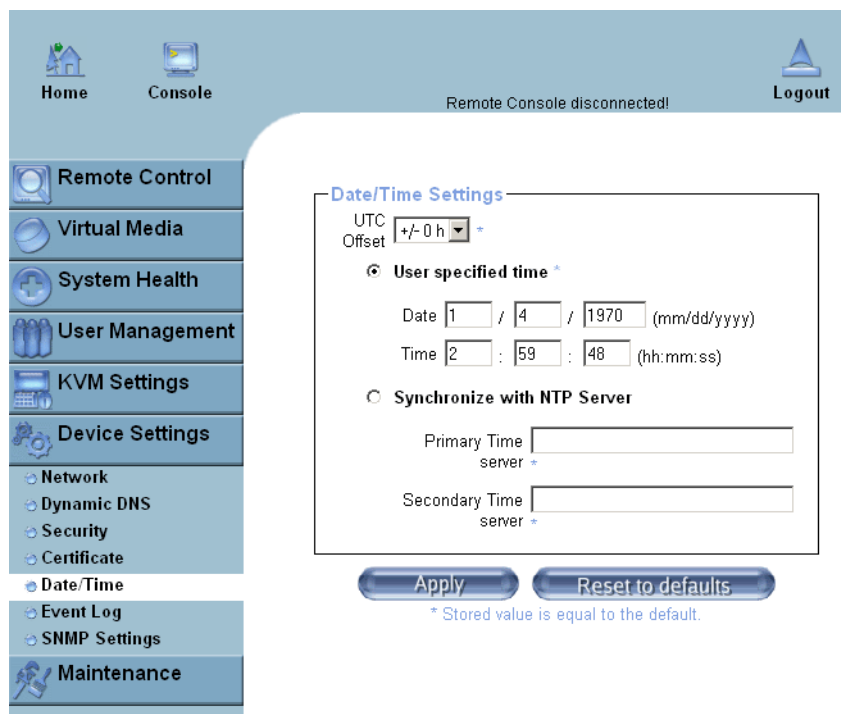

**Figure B-16** Date and Time Settings



Refer to Figure B-16.

- **UTC Offset:** This window enables you to offset the UTC Timer.
- **User Specified Time:** This option enables you to enter the time values for the BMC internal realtime clock.
- **Synchronize with NTP Server:** Enter the IP Address for the NTP (Network Time Protocol) Server that you want your BMC internal realtime clock to synchronize with.
- **Primary Time Server/Secondary Time Server:** Enter the IP Address for the primary NTP Server and the secondary NTP Server that you want to synchronize with your BMC internal realtime clock.

---

**Note:** The daylight saving time cannot be automatically adjusted. Please manually set up the UTC offset twice a year for your timer to work properly.

---

## Event Log

Click on this function key to activate its submenu. This feature enables you to set Event Log Targets and Event Log Assignment.

The screenshot shows the IPMI 2.0 Management Utility interface. At the top, there are navigation icons for Home, Console, and Logout. A left-hand navigation menu contains several categories: Remote Control, Virtual Media, System Health, User Management, KVM Settings, Device Settings, and Maintenance. Under Device Settings, several sub-items are listed: Network, Dynamic DNS, Security, Certificate, Date/Time, Event Log (which is selected), and SNMP Settings. The main content area displays the 'Event Log' with navigation links for '[ Prev ]' and '[ Next ]'. Below these links is a table with three columns: Date, Event, and Description. The table contains several entries, including authentication events for 'ADMIN' and 'ADM' users, and board messages indicating successful device starts.

Date	Event	Description
01/01/1970 02:10:19	Authentication	User 'ADMIN' logged in from IP address 66.120.31.163
01/01/1970 02:10:10	Authentication	User 'ADM' failed to log in from IP address 66.120.31.163
01/01/1970 01:25:11	Authentication	User 'ADMIN' logged in from IP address 66.120.31.163
01/01/1970 00:02:05	Authentication	User 'ADMIN' logged in from IP address 66.120.31.163
01/01/1970 00:00:33	Board Message	Device successfully started.
01/01/1970 00:00:59	Authentication	User 'ADMIN' logged in from IP address 192.168.1.36
01/01/1970 00:00:53	Authentication	User 'ADMIN' failed to log in from IP address 192.168.1.36
01/01/1970 00:00:33	Board Message	Device successfully started.

Figure B-17 Event Log

Refer to Figure B-17.

- **Event Log Targets:** This section enables you to manually set the event log targets and settings.
- **List Logging Enabled:** Check this box to activate the event-logging list. To show the event log list, click on “Event Log” on the “Maintenance” page.

---

**Note:** The maximum number of log list entries is 1,000 events. Every entry that exceeds this limit automatically overrides the oldest one in the list. If the reset button is pressed, all logging information is saved; however, all logging data is lost if hard reset is performed or the system loses power.

---

- **Entries Shown Per Page:** Enter the number of entries you want to display on a page.
- **Clear Internal Log:** Click this icon to clear internal event log from the memory.
- **NFS Logging Enable:** Click this box to enable NFS Logging that creates a Network File System (NFS) for writing the event logging data.
- **NFS Server:** Enter the IP Address of the NFS Server.
- **NFS Share:** Enter the path of the Network File System in which the event logging data is stored.
- **NFS Log File:** Enter the filename of the Network File System in which the event logging data is stored.
- **SMTP Logging Enable:** Check this box to enable the function of SMTP (Simple Mail Transfer Protocol) logging.
- **SMTP Server:** Enter the IP Address for the SMTP Server.
- **Receiver Email Address:** Enter the email address that the SMTP event logging data is sent to.
- **Sender Email Address:** Enter the email address from which the SMTP event logging data is sent.
- **SNMP Logging Enable:** Check this box to enable the function of SNMP (Simple Network Management Protocol) logging.
- **Destination IP:** Enter the IP address to where the SNMP trap is sent.
- **Community:** Enter the name of the community if the receiver requires a community string.
- **Click here to view the Supermicro Daughter Card SNMP MIB:** Click this link to see the SMLP card SNMP MIB.

- **Event Log Assignments:** This window enables you to specify the types and the destination for the event logging.

## SNMP Settings

Click on this function key to configure Simple Network Management Protocol (SNMP) settings.

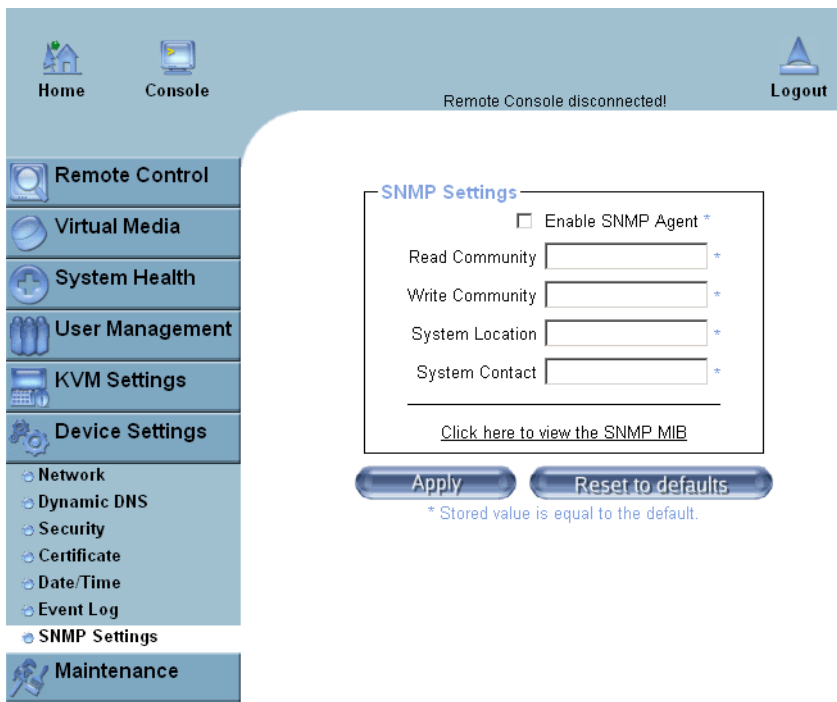

**Figure B-18** SNMP Settings

Refer to Figure B-18.

- **Enable SNMP Agent:** Check the box to enable the SNMP Agent and allow it to interface with your BMC card.
- **Read Community:** Enter the name of the SNMP Community from which you retrieve information via SNMP.
- **Write Community:** Enter the name of the SNMP Community to which you can write information and issue commands via SNMP.

- **System Location:** Enter the physical location of the SNMP host server. This location is used in response to the SNMP request as “sysLocation0.”
- **System Contact:** Enter the name of the contact person for the SNMP host server. This value is referred to as “sysContact0.”
- **Click here to view the SNMP MIB:** Click this link to view the SMLP card SNMP MIB file. This file may be necessary for an SNMP client to interface with the BMC card.

## Maintenance

Click on the Maintenance icon on the Home Page to activate its submenus, Device Information, Event Log, Update Firmware and Unit Reset Settings.

## Device Information

Click on this function key to activate its submenu. This feature displays the information of the BMC card and its firmware information.

The screenshot displays the IPMI 2.0 Management Utility interface. At the top, there are navigation links for Home, Console, and Logout. A vertical sidebar on the left contains the following menu items: Remote Control, Virtual Media, System Health, User Management, KVM Settings, Device Settings, and Maintenance. The Maintenance section is expanded, showing sub-items: Device Information (selected), Event Log, Update Firmware, and Unit Reset. The main content area is titled "Device Information" and contains the following details:

<b>Product Name:</b> Supermicro Daughter Card
<b>Serial Number:</b> 0752AA011844FCAC
<b>Device IP Address:</b> 137.38.82.236
<b>Device MAC Address:</b> 00:30:48:79:65:24
<b>Firmware Version:</b> 01.25.00
<b>Firmware Build Number:</b> 4238
<b>Firmware Description:</b> Jan-10-2007-9-36
<b>Hardware Revision:</b> 0x22

Below the device information, there is a link: [View the datafile for support.](#)

The "Connected Users" section shows:

<b>Connected Users</b>
ADMIN (137.38.88.212) active

Figure B-19 Device Information

Refer to Figure B-19.

- **View the Data File for Support:** Click on this link to view the XML file that contains your product information used for technical support.
- **Connected Users:** List the name(s), the IP Address(es) and the status of connected users.

## Event Log

Click on the Event Log function key to display a list of events that are recorded by the BMC in the order of Date/Time, Type, Descriptions IP address(es), person(s) and their activities (refer to Figure B-20).

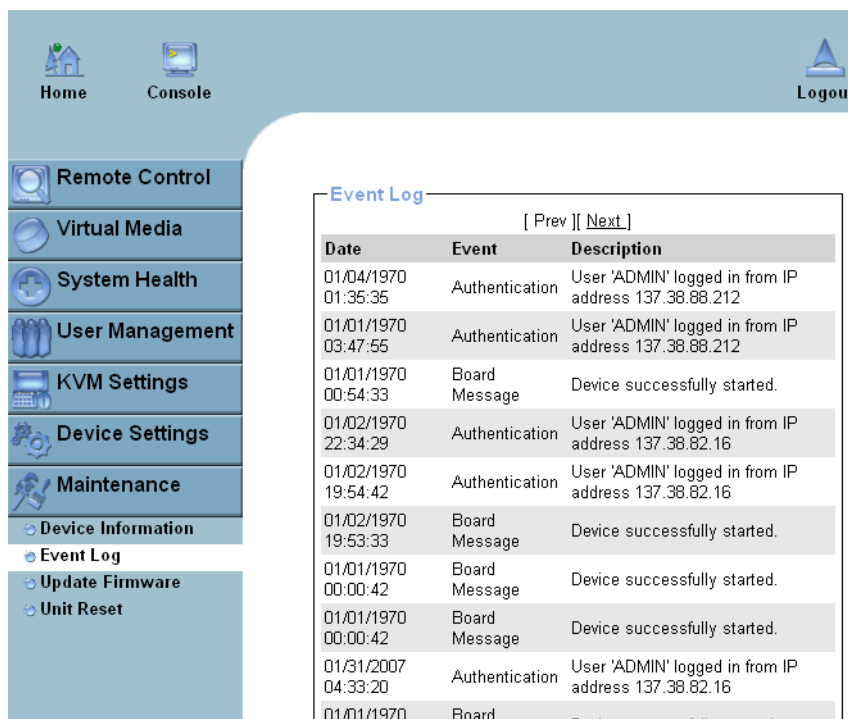

The screenshot shows the BMC Event Log interface. The navigation menu on the left includes: Home, Console, Remote Control, Virtual Media, System Health, User Management, KVM Settings, Device Settings, Maintenance, Device Information, Event Log (selected), Update Firmware, and Unit Reset. The Event Log table displays the following data:

Date	Event	Description
01/04/1970 01:35:35	Authentication	User 'ADMIN' logged in from IP address 137.38.88.212
01/01/1970 03:47:55	Authentication	User 'ADMIN' logged in from IP address 137.38.88.212
01/01/1970 00:54:33	Board Message	Device successfully started.
01/02/1970 22:34:29	Authentication	User 'ADMIN' logged in from IP address 137.38.82.16
01/02/1970 19:54:42	Authentication	User 'ADMIN' logged in from IP address 137.38.82.16
01/02/1970 19:53:33	Board Message	Device successfully started.
01/01/1970 00:00:42	Board Message	Device successfully started.
01/01/1970 00:00:42	Board Message	Device successfully started.
01/31/2007 04:33:20	Authentication	User 'ADMIN' logged in from IP address 137.38.82.16
01/01/1970	Board	Device successfully started.

**Figure B-20** Event Log

## Update Firmware

Click on this function key to update the BMC firmware.



**Figure B-21** Update Firmware

Refer to Figure B-21.

- **Firmware Upload:** Enter the name of the firmware you want to update or click on the “Browser” icon to select the firmware file.
- **Update:** Click on the “Upload” icon to upload the firmware file to the server for the update.

---

**Note:** This process is not reversible once the BMC firmware is updated, so proceed with caution. It might take a few minutes to complete the procedure.

---

## Unit Reset

This feature enables you to reset the USB or BMC.



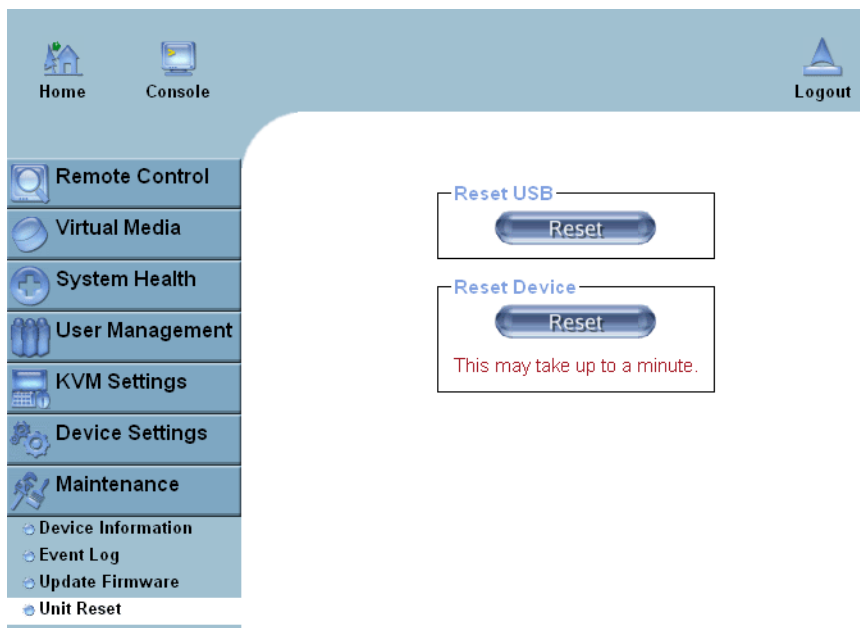

**Figure B-22** Unit Reset

Refer to Figure B-22.

- **Reset USB:** Click the “Reset” icon to reset the USB module.
- **Reset Device:** Click the “Reset” icon to cold reset the IPMI firmware.

## Remote Console Main Page

After you have entered the correct IP address for your remote console and typed in correct user name and password, you should be connected to the remote console. When the remote console is connected, the Remote Console window displays as shown in Figure B-23.

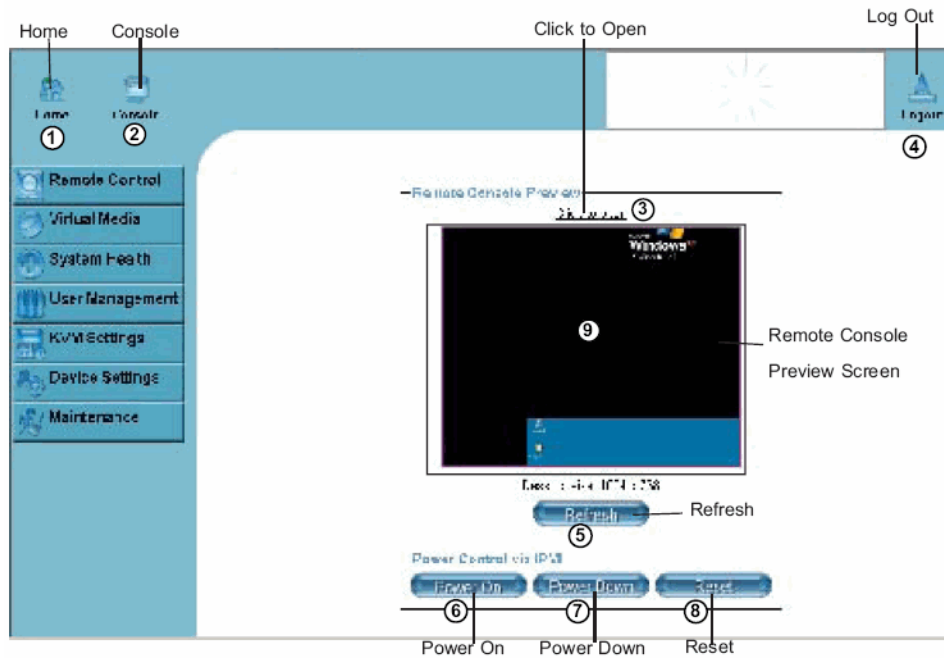

**Figure B-23** Remote Console Screen

- Click on the console icon (marked “2”) on the upper left corner, or
  - Click on the link “Click to Open” to open the remote console screen (refer to item 3 in Figure B-23).
1. **Home:** Click this icon to return to the Home Page.
  2. **Console:** Click this icon to open the remote console screen.
  3. **Click to Open:** Click this link to open the remote console screen.
  4. **Log-Out:** Click this icon to log out.
  5. **Refresh:** Click this icon to refresh the remote console preview screen.

6. **Power On:** Click this icon to power on the remote server.
7. **Power down:** Click this icon to power down the remote server.
8. **Reset:** Click this icon to reset the remote server.
9. **Remote Console Preview Screen:** This window displays the preview of the remote console screen. Click on this window to go to the remote console screen.

## Remote Console Options

After the remote console screen is displayed, click on the **Options** button in the upper right corner to display the Options Menu (refer to Figure B-24).

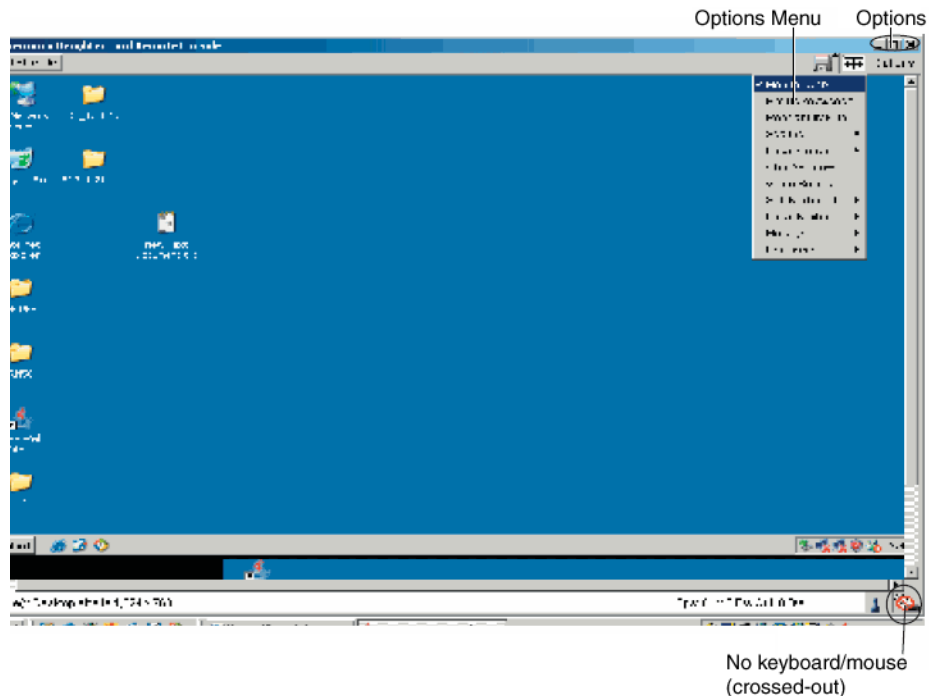

**Figure B-24** Remote Console Options

Options Menu items (refer to Figure B-24).

- **Monitor Only:** Click on the Monitor Only button to turn the function of “Monitor Only” on or off. If the function of “Monitor Only” is selected, the KB/Mouse icon on the lower right corner is crossed out as shown above, and the user can only view or monitor remote console activities. Any remote console interaction is no longer available.
- **Exclusive Access:** With an appropriate permission, a user can force other users to quit the remote console and claim the console for his or her own exclusive use by clicking on the Exclusive Access icon to select it. When this function is selected, the second user icon on the lower left corner of the screen is crossed out.
- **Readability Filter:** Click on this button to turn the “Readability Filter” on or off. Turn on this function to preserve most of the screen details even when the screen image is substantially scaled down.

---

**Note:** This item is available for a system with a JVM 1.4 or higher.

---

- **Scaling:** This item enables you to scale the remote console screen to a desired size. Click on this button to access its submenu and select a desired setting from the options listed in the submenu: 25%, 50%, 100% and Scale to Fit.
- **Local Cursor:** This item enables you to choose the desired shape for the local cursor pointer. Click on this button to access its submenu and select a desired shape from the options listed in the submenu: Transparent, Default, Big, Pixel, and Cross-hair. The availability of the shapes depends on the Java Virtual Machine used.
- **Chat Window:** This item enables you to communicate with other users logged in the same remote host by clicking on the Chat Window button. The screen below shows a Chat Window displayed in a scaled down remote console screen.

## Log Out

Return to the Home Page and click on the “Log Out” button to log out from Remote Console Interface.

## Regulatory Specifications and Safety Information

This appendix presents regulatory information that may be important to the operation of your SGI Altix XE310 server.

### Manufacturer's Regulatory Declarations

The SGI Altix XE310 products conform to several national and international specifications and European Directives listed on the "Manufacturer's Declaration of Conformity." The CE insignia displayed on each device is an indication of conformity to the European requirements.



---

**Caution:** Each SGI server system has several governmental and third-party approvals, licenses, and permits. Do not modify this product in any way that is not expressly approved by SGI. If you do, you may lose these approvals and your governmental agency authority to operate this device.

---

### Server Model Number

The CMN (model) number for each server is printed on the system label on the unit.

### CE Notice and Manufacturer's Declaration of Conformity

The "CE" symbol indicates compliance of the device to directives of the European Community. A "Declaration of Conformity" in accordance with the standards has been made and is available from SGI upon request.

## Electromagnetic Emissions

This section provides the contents of electromagnetic emissions notices for various countries.

### FCC Notice (USA Only)

This equipment complies with Part 15 of the FCC Rules. Operation is subject to the following two conditions:

- This device may not cause harmful interference.
- This device must accept any interference received, including interference that may cause undesired operation.

---

**Note:** This equipment has been tested and found to comply with the limits for a Class A digital device, pursuant to Part 15 of the FCC Rules. These limits are designed to provide reasonable protection against harmful interference when the equipment is operated in a commercial environment. This equipment generates, uses, and can radiate radio frequency energy and, if not installed and used in accordance with the instruction manual, may cause harmful interference to radio communications. Operation of this equipment in a residential area is likely to cause harmful interference, in which case you will be required to correct the interference at your own expense.

---

If this equipment does cause harmful interference to radio or television reception, which can be determined by turning the equipment off and on, you are encouraged to try to correct the interference by using one or more of the following methods:

- Reorient or relocate the receiving antenna.
- Increase the separation between the equipment and receiver.
- Connect the equipment to an outlet on a circuit different from that to which the receiver is connected.

Consult the dealer or an experienced radio/TV technician for help.



---

**Caution:** Changes or modifications to the equipment not expressly approved by the party responsible for compliance could void your authority to operate the equipment.

---

### **Industry Canada Notice (Canada Only)**

This Class A digital apparatus meets all requirements of the Canadian Interference-Causing Equipment Regulations.

Cet appareil numérique n'émet pas de perturbations radioélectriques dépassant les normes applicables aux appareils numériques de Classe A prescrites dans le Règlement sur les interférences radioélectriques établi par le Ministère des Communications du Canada.

### **VCCI Class A Notice (Japan Only)**

この装置は、情報処理装置等電波障害自主規制協議会 (VCCI) の基準に基づくクラス A 情報技術装置です。この装置を家庭環境で使用すると電波妨害を引き起こすことがあります。この場合には使用者が適切な対策を講ずるよう要求されることがあります。

### **Shielded Cables**

The SGI Altix XE310 product is FCC compliant under test conditions that include the use of shielded cables between the server and its peripherals. Your server and any peripherals that you purchase from SGI have shielded cables. Shielded cables reduce the possibility of interference with radio, television, and other devices. If you use any cables that are not from SGI, ensure that they are shielded. Telephone cables do not require shielding.

Optional monitor cables supplied with your server system use additional filtering molded into the cable jacket to reduce radio frequency interference. Always use the cable that is supplied with your system. If your monitor cable becomes damaged, obtain a replacement cable from SGI.

### **Electrostatic Discharge**

SGI designs and tests its products to be resistant to the effects of electrostatic discharge (ESD). ESD is a source of electromagnetic interference and can cause problems ranging from data errors and lockups to permanent component damage.

It is important that you keep all the covers and doors, including the plastics, in place while you are operating the server system. The shielded cables that came with the server and its peripherals should be installed correctly, with all thumbscrews fastened securely.

An ESD wrist strap may be included with some products, such as memory or PCI upgrades. Use the wrist strap when you install these upgrades to prevent the flow of static electricity; it is designed to protect your system from ESD damage.



# System Specifications

---

**Note:** Unless noted, specifications apply to entire system (both nodes).

---

**Table D-1** SGI Altix XE310 System Specifications

Specification	Description
Compute nodes	Two compute nodes per chassis
Processors	Up to four Dual or Quad-Core Intel® Xeon® Processors, (two per node) Front Side Bus: 1333 or 1066 MHz CPU clock rates: (3.00 GHz - Woodcrest), (2.66, 2.33, 2.0 GHz - Clovertown) L2 Cache: 4.0 MB for Dual-core, 8.0 MB for Quad-core
Chipset	Intel 5000P
BIOS	Phoenix BIOS® in 8 MB Flash EEPROM (per node)
Memory	16 DIMM slots to support a maximum up to 64 GB of ECC fully buffered DIMM (FBDIMM) DDR2-667533 SDRAM (32 GB per node) <b>Note:</b> Interleaved memory requires DIMMs to be installed in pairs. Refer to “Install Memory” on page 50 for more information.
SATA controller	Intel ESB2 on-chip controller to support four 3 Gb/s serial ATA (SATA) RAID 0 and 1
SATA drive bays	Four SATA drive bays (two per node) 3.5-in. SATA drive - 250 GB, 7200 rpm - 500 GB, 7200 rpm
PCI expansion	Two low-profile PCIe x8 cards with pre-installed riser cards (1 per node)
Integrated I/O	2 x InfiniBand® ports (1 per node), optional 2 x COM ports (1 per node) 2 x VGA ports (1 per node) 4 x Gigabit Ethernet ports (2 per node) 4 x USB ports (2 per node)

**Table D-1** SGI Altix XE310 System Specifications **(continued)**

<b>Specification</b>	<b>Description</b>
Cluster interconnects	InfiniBand or Gigabit Ethernet Two external 4X DDR InfiniBand port (optional) Two external Gigabit Ethernet ports (one per node)
Node board dimensions	6.5 in. x 16.4 in. (165 mm x 417 mm)
Chassis	1U rackmount Dimensions: Width: 17.2 in. (437 mm) Height: 1.7 in. (43 mm) Depth: 27.75 in. (705 mm)
Weight	Weight: 40 lb (18.2 kg)
System cooling	Six high performance 4-cm fans
System input requirements	AC Input Voltage: 200 - 240 VAC (North America/Japan/International) Rated Input Current: 12A - 5A max Rated Input Frequency: 50 to 60 Hz
Power supply	Rated Output Power: 980 Watts Rated Output Voltages: +12V @ 81A, +5V @ 4A
BTU rating	5173 BTUs/hr (for rated output power of 980 Watts)
Rack power requirements	Short rack: 8 kW Tall rack: 32 kW

---

**Table D-1** SGI Altix XE310 System Specifications **(continued)**

<b>Specification</b>	<b>Description</b>
Operating environment	Operating Temperature: 10° to 35° C (50° to 95° F) Non-operating Temperature: -40° to 70° C (-40° to 158° F) Operating Relative Humidity: 8% to 90% (non-condensing) Non-operating Relative Humidity: 5% to 95% (non-condensing)
Regulatory compliances	Electromagnetic Emissions: FCC Class A, EN 55022 Class A, EN 61000-3-2/-3-3, CISPR 22 Class A  Electromagnetic Immunity: EN 55024/CISPR 24, (EN 61000-4-2, EN 61000-4-3, EN 61000-4-4, EN 61000-4-5, EN 61000-4-6, EN 61000-4-8, EN 61000-4-11)  Safety: EN 60950/IEC 60950-Compliant UL Listed (USA) CUL Listed (Canada) TUV Certified (Germany) CE Marking (Europe)

---



## System Safety

### Electrical Safety Precautions



---

**Caution:** Follow these basic electrical safety precautions to protect yourself from harm and the SGI Altix XE310 from damage.

---

- Be aware of the locations of the power on/off switch on the chassis, as well as the room's emergency power-off switch, disconnection switch or electrical outlet. If an electrical accident occurs, you can then quickly remove power from the system.
- Do not work alone when working with high voltage components. Power should always be disconnected from the system when removing or installing main system components, such as the node boards, memory modules and processors (not SATA drives). When disconnecting power, you should first power down the system with the operating system first and then unplug the power cord from the power supply unit.
- When working around exposed electrical circuits, another person who is familiar with the power-off controls should be nearby to switch off the power if necessary.
- Use only one hand when working with powered-on electrical equipment. This is to avoid making a complete circuit, which will cause electrical shock.
- Use extreme caution when using metal tools, which can easily damage any electrical components or circuit boards they come into contact with.
- Do not use mats designed to decrease static electrical discharge as protection from electrical shock. Instead, use rubber mats that have been specifically designed as electrical insulators.
- The power supply power cord must include a grounding plug and must be plugged into a grounded electrical outlet.

## Node Board Battery



**Caution:** There is a danger of explosion if the onboard battery is installed upside down, which reverses its polarity (refer to Figure E-1). This battery must be replaced only with the same or an equivalent type recommended by the manufacturer. Dispose of used batteries according to the manufacturer's instructions.

---

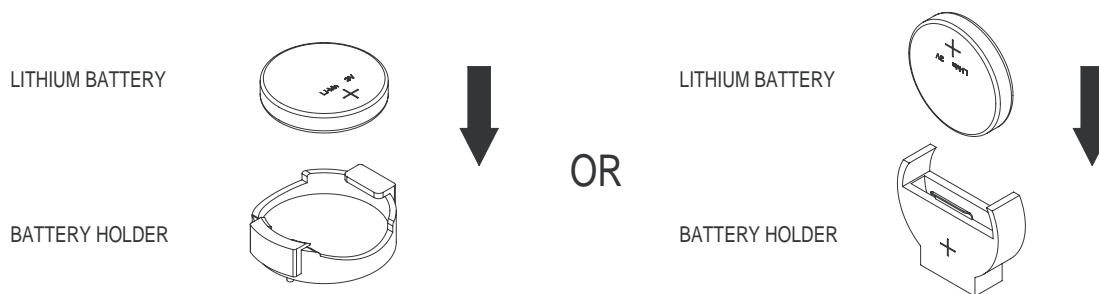

**Figure E-1** Install the Battery

## General Safety Precautions



---

**Caution:** Follow these general safety precautions to protect yourself from harm and the SGI Altix XE310 from damage.

---

- Keep the area around the SGI Altix XE310 clean and free of clutter. Failure to do so may cause the system to become overheated and damage the equipment.
- The SGI Altix XE310 weighs approximately 40 lbs (18.2 kg) when fully loaded. When lifting the system, two people at either end should lift slowly with their feet spread out to distribute the weight. Always keep your back straight and lift with your legs. Failure to use proper lifting techniques may result in personal injury or equipment damage.
- Place the chassis top cover and any system components that you remove on a sturdy ESD-safe table. Failure to do so may result in equipment damage from electrostatic discharge.
- Do not wear loose clothing such as neckties or unbuttoned shirt sleeves which can come into contact with electrical circuits or be pulled into a cooling fan. Failure to do so may result in personal injury or equipment damage.
- Remove any jewelry or metal objects from your body, which are excellent conductors of electricity and can create short circuits. Failure to do so may result in personal injury or equipment damage.
- After accessing the inside of the system, close the system back up and secure it to the rack unit with the retention screws after ensuring that all connections have been made.

## ESD Safety Precautions



---

**Caution:** Follow these general ESD precautions to protect the electrostatic-sensitive devices (ESD) inside SGI Altix XE310 from damage.

---

Electrostatic discharge is generated by two objects with different electrical charges coming into contact with each other. An electrical discharge is created to neutralize this difference, which can damage electronic components and printed circuit boards. The following measures are generally sufficient to neutralize this difference before contact is made to protect your equipment:

- Use a grounded wrist strap designed to prevent static discharge.
- Keep all components and printed circuit boards (PCBs) in their antistatic bags until ready for use.
- Touch a grounded metal object before removing the board from the antistatic bag.
- Do not let components or PCBs come into contact with your clothing, which may retain a charge even if you are wearing a wrist strap.
- Handle a board by its edges only; do not touch its components, peripheral chips, memory modules, or contacts.
- When handling chips or modules, avoid touching their pins.
- Put the node board and peripherals back into their antistatic bags when not in use.
- Make sure your computer chassis provides an excellent conductivity path between each of the system components and chassis ground.

## Operating Precautions



---

**Caution:** Never operate the SGI Altix XE310 server with the chassis cover removed. The cover must be in place to maintain proper airflow and cooling of the system components. Operating the SGI Altix XE310 without the chassis cover in place can damage the equipment.

---



## Upgrading Your Server for SAS/RAID Support

Your Altix XE310 server is a dual-node system that can have a maximum of two hard drives per node. This appendix describes how to upgrade your server to use SAS hard drives as well as SATA hard drives by using model LSISAS3041E HBAs. This HBA option also can provide support for RAID 0, RAID 1, or JBOD.

---

**Caution:** Some levels of RAID are designed to increase the availability of data and some to provide data redundancy. However, creating a RAID configuration is not a substitute for a reliable backup strategy. Back up all data regularly to guard against data loss. It is especially important to back up all data before working on any system components and before installing or changing the RAID configuration.

---

### Installing the HBAs

**Components Required:**

- SAS or SATA drives
- LSISAS3041E HBA (two if updating both nodes)

---

**Note:** HBAs are not pre-configured.

---

- 72-cm cables (two if updating both nodes)

**Additional Reference:**

*PCIe to 3.0 Gbits/s SAS Host Adapters User's Guide*

You can find reference documents on the SGI Technical Publications Library (<http://docs.sgi.com>).

To install the LSI SAS3041E HBA, follow these general steps:

1. Power down the server using the normal power-down procedure.
2. Remove the power cord from the rear of the system.
3. Remove the screws from the top cover.
4. Remove the top cover and set it aside.
5. Remove the fan assemblies.

There are three fan assemblies per node.

6. Unplug the fan power from the motherboard.
7. Remove all SATA cables from the motherboard and hard disk drives.

There are four cables of various lengths in the SATA system: 37 cm, 41 cm, 47 cm, and 53 cm. You will need the two longer cables to install the HBA.

8. If you are upgrading to SAS drives, remove the SATA drives from the drive carriers and insert SAS drives.

---

**Note:** If you are upgrading to use the RAID option of the HBA, ensure that all drives are identical. Mixed drives relative to capacity and type can result in degraded performance.

---

9. Install the HBA in each node, if desired.

Each node requires a 72-cm cable and either a 47- or 53-cm cable. Connect the 72-cm cables to the rightmost drive of each node. Connect the shorter cable to the left drive of each node.

The left node (relative to facing the front of the system) requires a 72-cm and a 53-cm cable for reconnection. The right node requires a 72-cm and a 47-cm cable.

You route the cables for the two nodes in the same fashion:

- a. Connect the right angle cable ends to the hard disk drive.
- b. Route the cable to the left and along the left side of the node towards the rear of the system.
- c. Connect to the newly installed HBA.

Any of the four connectors works equally well on the HBA.

10. Re-install and reconnect the fans and air shrouds.
11. Re-install the top cover of the system and re-apply power.

## Creating RAID Volumes

RAID volumes can be created using the LSI SAS BIOS Configuration Utility. When BIOS loads during boot and you see the message about the LSI Configuration Utility, press `Ctrl-C` to start the configuration utility. For more information, refer to the *Integrated RAID for SAS User's Guide*.

The LSI Logic MPT Configuration Utility included in SGI ProPack 5 for Linux (or higher) can be used to manage your RAID when booted into the OS. To start the configuration utility and select the SAS controller, enter the following:

```
lsiutil
```

The LSI SAS3041E HBA uses the LSI SAS1064E SAS controller. For additional help, enter the following:

```
lsiutil -h
```



## Upgrading BIOS

There are several ways to flash BIOS firmware in the SGI XE310 platform:

- Bootable DOS CDROM
- Bootable DOS USB flash drive
- Bootable DOS image via the Virtual Media boot feature from the BMC web interface

To obtain and perform BIOS upgrades using the first two methods cited, visit the SGI Supportfolio website:

<https://support.sgi.com/login>

If you are upgrading BIOS in a cluster, use the BMC web interface. This appendix describes the procedure.

## Requirements

The Virtual Media boot method from the BMC web interface allows you to flash the BIOS without connecting any external media readers or USB flash devices. You will need the following:

- Bootable DOS image file
- Samba or Windows shared mount
- Web browser

## Setting up the Virtual Media Boot Feature

To set up the Virtual Media boot feature, you must create a Samba (SMB) shared mount on the cluster headnode. Perform the following steps:

1. Ensure that `smb` (Samba package) is installed on the server.
2. Enable `smb` by entering the following:

```
chkconfig smb on
```

3. Create a directory for the BIOS bootable DOS images by entering the following:

```
mkdir /BIOS
```

4. Add the following lines to file `/etc/samba/smb.conf`:

```
[bios]
comment = Bios Upgrade
path = /BIOS
public=no
valid users = root
writeable = Yes
force create mode = 0770
force directory mode = 0775
```

5. Create an `smb` password for `root` by entering the following and supplying a password when prompted:

```
smbpasswd -a root
```

The SGI factory setting for the password is `sgisgi`.

6. Start the `smb` service by entering the following:

```
/etc/init.d/smb start
```

## Booting the Virtual Media DOS Image

To boot the Virtual Media DOS image, perform the following steps:

1. Open a web browser.
2. In the URL address, enter the BMC IP address or BMC hostname of the system you want to boot the DOS image.
3. Log in to the BMC web interface.  
The SGI factory default value for both `login` and `password` is `admin`.
4. Click the **Virtual Media** tab on the left side of screen.
5. Select **CD-ROM image**.
6. In the **Image on Windows Share** box, enter the following information:

**Virtual Drive** = 1

**Share Host** = *IP-address-of-headnode-admin-network* (10.0.10.1 is the SGI factory default.)

**Share Name** = `bios`

**Path to image** = *image-filename-to-boot* (located in `/BIOS` dir)

**User** = `root` (SGI factory default)

**Password** = `sgisgi` (SGI factory default)

7. Click the **Set** button.

This ensures that the boot image is successfully set to boot.

The boot order in the BIOS has been automatically set to boot this image before any other boot device. The image will boot at the next reboot/power cycle.

---

**Note:** You must unset this image when you are done booting on it. Otherwise, all subsequent reboots will boot from this virtual image. Repeat steps 1, 2, and 3; then click the unset button.

---





---

# Index

## Numbers

3rd-party rack, installation, 19

## A

ACPI mode, 109

Air shroud, removal and installation, 57

Airflow, 24

Alert settings, 163

ATI graphics controller, 6

ATX power connectors, 61

## B

### BIOS

battery backup, 101

default settings, 93

main menu, 103

#### POST

codes, 137

messages, 131

upgrading, 209

BMC, 145

device information, 185

locations, 3

reset, 188

### Boot

devices, 128

setup, 108

## C

Cautions, 10

CD-ROM image, 153

Certificate settings, 178

### Chassis

front view, 84

overview, 2

rear view, 84

specifications, 197

CMOS memory, 75

### Connector

locations, 58

pin definitions, 63

### Console

remote, 190

user, 167

### Control panel

cabling, 85

connector, 34

LEDs, 26

switches, 25

### Cooling, 24

adjusting fan speed, 87

Customer service, xxvi

## D

Date and time, 104, 180

Device settings, 172, 172

## DIMM

- banks, 55
- configuration rules, 50-54
- installing, 50
- slot locations, 58
- sockets, 4

## Disk drive

- carrier, 88
- installation, 88
- locations, 3
- part number, 86
- replacement, 87
- types, 4, 6, 205

## DNS, dynamic, 174

## Documentation

- available via the World Wide Web, xxv
- conventions, xxvi

## Drive redirection, 155

## Dynamic, DNS, 174

## E

### Earth ground, 12

### Electrical safety, 201

### Electromagnetic emissions, 194

### Electrostatic discharge

- regulatory notice, 195

### ESB2

- SATA controller, 4

### ESD precautions, 30, 83

### Ethernet ports, 6

### Event log, 182, 187

## F

### Fans, 24

- adjusting speed, 87

### part number, 86

### replacement, 87

### FCC notice (USA only), 194

### Firmware

- update, 188

### Front panel, 26

## G

### Gigabit LAN ports, 6

### Graphics, 6

### Ground, earth, 12

## H

### Heatsink

- installation procedure, 40
- removal procedure, 41

## I

### I2C bus

- overview, 7

### IDE

- controllers, 6
- parameters, 105

### Indicators, 26

### Input power, 24

### Interleaved memory, 50

### I/O

- panel, 6
- performance, 111
- port locations, 35

### IPMI

- configuration in BIOS, 122
- overview, 145

**J**

- J17 description, 61
- J18 description, 61
- JBT1
  - clear CMOS memory procedure, 75
  - description, 61
- JF1
  - connector cable routing, 34
  - description, 61
- JI2C1/JI2C2 description, JPG1 description, 61
- JP10 description, 61
- JPI2C description, 61
- JPL1/JPL2 description, 61
- Jumper
  - default settings, 61
  - locations, 58
- JWD description, 61
- JWOL description, 61
- JWOR description, 61

**K**

- Keyboard
  - settings, 170
- KVM
  - console, 150
  - over LAN, 145
  - settings, 167

**L**

- LAN1/LAN2 description, 61
- LE1 description, 62
- LE2 description, 62
- LE3 description, 62

**LEDs**

- control panel, 26
- NIC1, 27
- NIC2, 27
- overheat/fan fail, 26
- SATA drive carrier, 27

**M**

- MAC address, 29
- Manufacturer's declaration of conformity, 193
- Manufacturer's regulatory declarations, 193
- Marketing codes, 86
- Media Access Control (MAC) ethernet address, 29
- Memory
  - branch mode, 113
  - cache, 110
  - configuration, 113
  - configurations, 55
  - installing, 50
  - memory mirroring, 53
  - memory sparing, 53
  - POST, 101
- Monitor sensors, 160
- Mouse
  - settings, 170
- Mouse mode, 151

**N**

- Network settings, 172, 172
- NIC1 LED, 27
- NIC2 LED, 27
- Node board
  - block diagram, 5
  - component locations, 58
  - configuring a single processor, 35

- connector pin definitions, 63
- default jumper settings, 61
- installation, 31
- LEDs, 62
- locations, 3, 26
- part number, 86
- power connectors, 32
- precautions, 29, 35
- removal, 31
- software licensing and MAC address, 29
- specifications, 197
- unpacking, 30

## O

- Overheat/fan fail LED, 26

## P

- Part numbers, 86
- Password
  - changing, 164
  - for user root, 7
- PCIe
  - configuration, 111
  - installing expansion cards, 59
  - I/O performance, 111
  - slots, 6
- Permissions, 166
- PnP cap, 36
- POST
  - errors, 109
  - memory test, 101
  - quickboot mode, 108
- Power supply, 24
  - connectors, 32
  - overview, 7
  - part number, 86

- replacement, 90
- Power switch, 25
- Processor
  - configuring a single-processor board, 35
  - heatsink precautions, 35
  - installation procedure, 36
  - locations, 58
  - removing, 48
- Product support, xxvi

## R

- Rack
  - 3rd-party installation, 19
  - precautions, 10
- RAID
  - configurations, 7
  - SAS/RAID support, 6, 205
- Regulatory compliances, 199
- Regulatory declarations
  - manufacturer, 193
- Regulatory specifications
  - CE notice and Manufacturer's declaration of conformity, 193
  - electromagnetic emissions, 194
  - electrostatic discharge, 195
  - FCC notice (USA) only, 194
  - manufacturer's regulatory declarations, 193
  - shielded cables, 195
- Remote console
  - options, 191
  - power functions, 150
- Replacement procedures
  - disk drive, 87
  - fans, 87
  - memory, 50
  - node board, 31
  - power supply, 90

Reset  
  BMC, 188  
  switch, 25

## S

Safety precautions, 201  
SAS drives, 6, 205  
SATA  
  backplane, 7  
  controller mode, 106  
  disk drives, 7  
  drive carrier LEDs, 27  
  drive locations, 3  
  drives, 4  
  overview, 4  
SATA0-SATA3 description, 61  
Security  
  BMC settings, 175  
  options in BIOS, 126  
  password for user root, 7  
Sensors, 160  
Serial ATA (See SATA .)  
Serial Attached SCSI (SAS) drives (See SAS drives .)  
Server model number, 193  
Setting the date and time, 104  
Setup menu, accessing, 102  
SGPIO description, 61  
Shielded cables  
  regulatory notice, 195  
Shipping container, 9  
SIMSO IPMI description, 61  
SNMP settings, 184  
Southbridge, 4  
Specifications, 197  
Standby power, 25  
System event log, 162

System health, 158  
System time, 104

## T

Technical support, xxvi  
Thermal interface material (TIM), 42  
Third-party rack, installation, 19  
TIM, 42  
Top cover  
  removal, 22, 23, 31

## U

Unpacking, 9  
  node board, 30  
UPS, 11, 24  
USB0/1/2/3 description, 61  
User console, 167  
User management, 164  
Users and groups, 165

## V

Virtual media, 151  
Virtual media options, 157

## W

Warnings and Cautions, 10  
Watch dog timer, 109

